



VECTOR-II 48" AC CEILING FAN

**Corrosion resistance
with a modern design**

50W
AC
MOTOR

ABS
BLADES

48
INCH
1220mm

9939
m³/hr
AIRFLOW

15°
CEILING
RAKE MAX

6YR
WARRANTY

Wall control
Included



Watch our demonstration video here

Vector fans are made from rust and UV resistant ABS plastic giving you endless options of where you can place them around your home. A simple modern design will compliment any space whilst giving you a great airflow.

- Patented* Ezi-Fit blades reduce fan assembly and installation time
- Durable corrosion and UV resistant body and canopy construction with high strength moulded ABS blades
- 3 speed wall control with switch included
- Reversible All-Seasons technology for use all year round
- 85% pre-assembled out of the box for fast installation
- Powerful 50W AC motor
- 18W 1400lm Cool White (4000K) dimmable LED light kit (model with light only)
- Uses our Quick Connect Plug System to reduce installation time
- Suitable for indoor or enclosed alfresco areas
- Compatible with Brilliant remotes and BrilliantSmart fan controllers

APPLICATIONS

- Bedrooms, lounge and family rooms
- Indoors or enclosed alfresco areas not exposed to the weather



PURE WHITE NO LIGHT



PURE WHITE WITH LIGHT



VECTOR-II 48" AC CEILING FAN

TECHNICAL SPECIFICATIONS

Size	48 inch (1220mm)
Motor Type	AC (Alternate Current)
Operating Voltage	240V / 50Hz
Motor Wattage	50W
Construction	ABS body and canopy
Blade Material	Moulded ABS (x4)
Ceiling install	Hangsure
Blade Pitch	14 degree (effective)
Ceiling Rake	15 degree max
Control	Wall 3 speed with on/off switch (included)
Light Wattage:	18W
Lumens:	1400lm (4000K)
Dimmable:	Yes
Other models available	21548/05: 52-inch no light 21549/05: 52-inch with light
Warranty	3 year in-home plus 3 year replacement (6-Year) <i>*Limited warranty for wall controller, remote controller and light. Refer to warranty card inside the box for more details.</i>
Standards:	AS/NZS 60335-1 AS/NZS 60335-2-80 AS/NZS 60598-1 AS/NZS 60598-2-1
Patent:	2018201157 (pending)

INSTALLATION

Must be installed by a licensed electrician

ACCESSORIES (sold separately)

Extension Rod with loom kits, 900mm x Ø21mm:

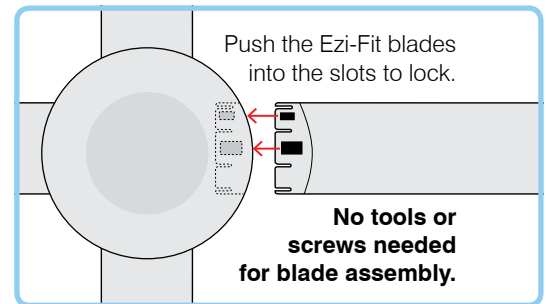

Remote Kits
99999 Basic
99222 LCD Display
99111 Smart WiFi

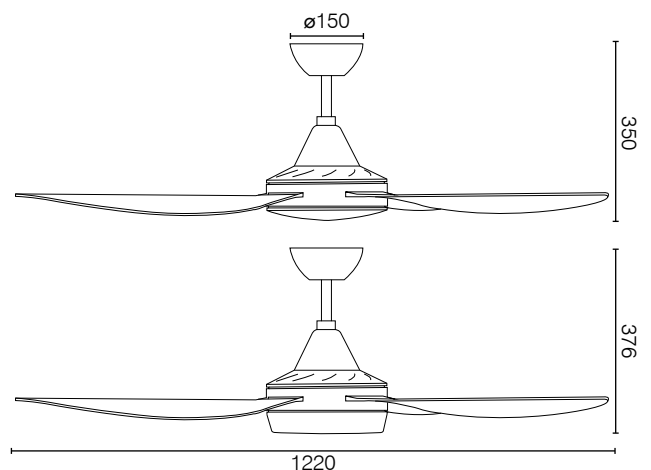

AIR MOVEMENT:

SPEED	LOW	MED	HIGH
RPM	114	161	224
Power	14W	25W	50W
Airflow	4,645m ³ /h	6,776m ³ /h	9,939m ³ /h



	MODEL	COLOUR	DESCRIPTION	BOX SIZE	GROSS WEIGHT	BOX QTY	BARCODE/TUN
RETAIL BOX	21546/05	Pure White	Vector-II 48 AC Fan	W591 x H318 x D288 mm	6.5 kg	1 pc	 9 312641 215462 >
RETAIL BOX	21547/05	Pure White	Vector-II 48 AC Fan & Light	W591 x H318 x D288 mm	6.7 kg	1 pc	 9 312641 215479 >