



Batten down easier
than ever
before!

NEW

Improved design

2530

Battenholders

clipsal.com

2530

Battenholders

Batten down easier than ever before!

Effortless fit-off and even better design

Clipsal's range of battenholders is already light years ahead of the competition in every way. But that doesn't stop us from trying to improve them. Through feedback from our loyal customer base, we've identified areas for improvement and developed heaps of new features to make your life easier.

Front access to terminals allows easier termination and the bigger cable capacity gives you plenty of room to move. Terminals are accessible, even after installation, allowing you to easily diagnose problems. Finger guards protect both the contractor and the homeowner from accidental contact after installation. Finally, to ensure a clean appearance, there are no unsightly screwheads.

Fit-off especially has never been easier. By simply rotating the cover 120° for easy removal, the terminals can be accessed. After installation a new built-in safety feature prevents the cover from accidentally falling onto a hot globe.

Available in three different models (see below), there's a model to suit every application.

Rating 3A, 250V.



Fitting Options



2530

Universal – fits to any surface with fasteners of your choice.



2530LT

Loose fixing plugs that grip and expand on mounting surface (e.g. Gyprock) when tightened.



2530T

Brand New! – Comes with pre-positioned screw/nail and tapered fixing plug. This plug and screw can be removed to provide a universal fastening option if required.

Check out these great features



 Front access to terminals allowing easy adjustment of terminals, even after installation

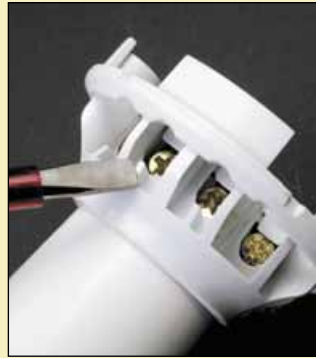

 Large combo head screws can accept flat or Phillips-head screwdrivers, including power bits



 Easy cable viewing access allows diagnosis of problems without having to remove product from ceiling (great for fault finding)



 Secondary fixing position for extra stability on unstable surfaces



 Finger guards protect against accidental contact to terminals

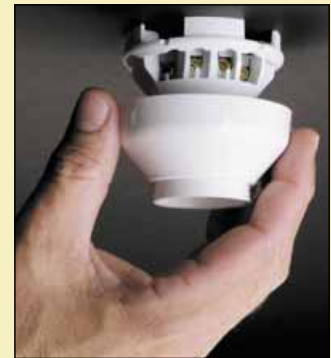

 Cover can be completely removed after aligning the indicators and rotating 120°



 Built-in recess also allows cover to be easily levered off with a screwdriver



 Built-in safety feature to ensure removable cover does not fall onto globe

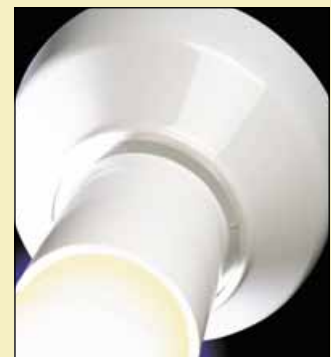

 No exposed, unsightly screwheads

2530T Additional Features

Fast fixing sequence

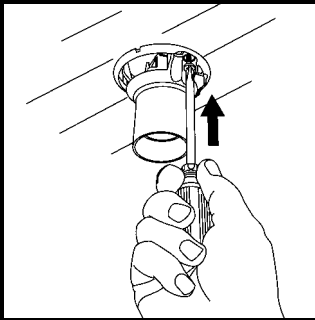

1. Using screwdriver, push screw nail through fastening plug.

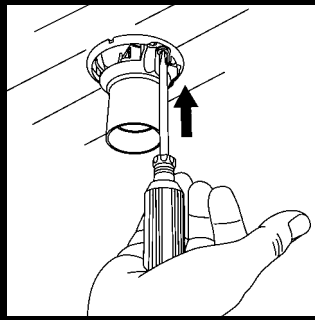

2. Using palm of hand, apply extra force to ensure screw nail is secure (repeat steps 1 & 2 on other fixing plug).

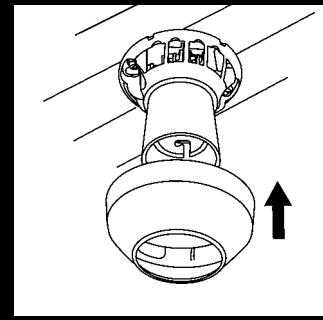

3. Push cover on.

To alter 2530T into a universal battenholder (or to remove screw nails and plugs), the following procedure should be followed:

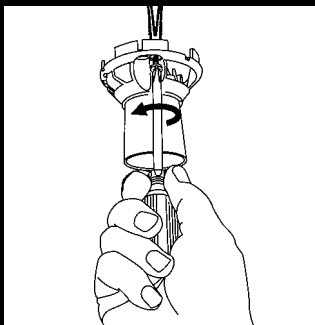

4. Remove screw nail.

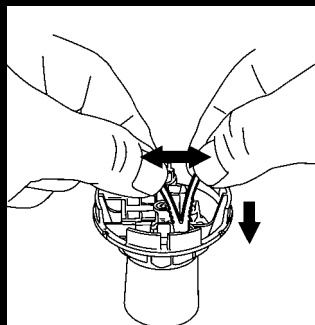

5. Spread apart legs of fixing plug and push down

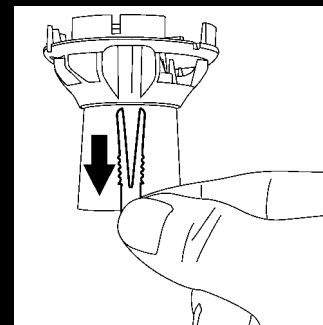

6. Remove fixing plug (repeat steps 1-3 on other fixing plug and screw nail).

Product of Clipsal Australia Pty Ltd

ABN 27 007 873 529

Head Office

12 Park Terrace, Bowden
South Australia 5007
Telephone (08) 8269 0511
Facsimile (08) 8340 1724
Internet clipsal.com
E-Mail plugin@clipsal.com.au

National Customer Service Enquiries:

1300 2025 25

National Customer Service Facsimile:

1300 2025 56

Area Representatives

NSW	Albury	(02) 6041 2377
	Central Coast	0418 430 361
	Coffs Harbour	0418 653 183
	Dubbo	0418 822 564
	Newcastle	0407 298 792
		0418 434 169
		0418 686 040
	Tamworth	0417 714 339
	Wagga Wagga	0418 578 903
	Wollongong	0418 423 581
ACT	Canberra	0419 238 824
	Canberra/Goulburn	0418 164 070
	Canberra/Yass	0419 847 732
VIC	Ballarat	0418 336 291
	Bendigo	0418 570 213

	Geelong	0418 527 233
	Gippsland	0418 512 680
	Mornington Pen.	0407 795 291
	Western Victoria	0419 380 444
QLD	Cairns	0418 773 254
	Gold Coast	0419 636 633
	Mackay	0418 752 134
	Maryborough	0418 664 338
	Northern Rivers	0418 768 902
	Rockhampton	0419 869 752
	Sunshine Coast	0418 711 786
	Toowoomba	0418 726 394
	Townsville	0418 180 372
WA	Bunbury	0418 931 684
	Kalgoorlie &	0417 928 981
	Eastern Gold Fields	
	Karratha	0418 937 249
SA	Riverland/Mildura/ Broken Hill	0418 596 145
NT	Darwin	0417 454 411
TAS	All Areas	0400 979 340

International Enquiries

International Sales and Marketing
Telephone + 61 8 8269 0587
Facsimile + 61 8 8340 7350
E-Mail export@clipsal.com.au

New Zealand

Clipsal Industries (NZ) Ltd

Telephone (09) 576 3403
Facsimile (09) 576 1015
E-Mail headoffice@clipsal.co.nz

Customer Service

Free Fax (0508) 250 305
Auckland/Mobile Phone (09) 572 0014
Free Phone (0508) CLIPSAL
2547725

You can find this brochure and many others online in PDF format at:
clipsal.com

Follow the links off the home page or access the following page directly:
clipsal.com/wat_lib_pdf.cfm

clipsal.com

Clipsal Australia Pty Ltd reserves the right to change specifications, modify designs and discontinue items without incurring obligation and whilst every effort is made to ensure that descriptions, specifications and other information in this catalogue are correct, no warranty is given in respect thereof and the company shall not be liable for any error therein.

©Copyright Clipsal Australia Pty Ltd 2006.
All rights reserved.

This material is copyright under Australian and international laws. Except as permitted under the relevant law, no part of this work may be reproduced by any process without prior written permission of and acknowledgement to Clipsal Australia Pty Ltd.