

CLIPSAL®

by Schneider Electric

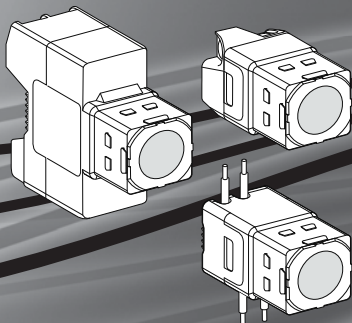

by Schneider Electric



Iconic Series

Pushbutton Electronic Switch

41E350PBES2SM-VW | PDL356PBSM-VW
41E6PBES3SBM-VW | PDL356PBMTBT-VW

Pushbutton Timer

41E350PBT2SM-VW | PDL348PBTM-VW
41E6PBT3SBM-VW | PDL348PB6TMBT-VW
41E10PBT3SBM-VW | PDL348PB10TMBT-VW

Timeclock

41E6PBTC3SBM-VW | PDL346PB6TCMBT-VW
41E10PBTC3SBM-VW | PDL346PB10TCMBT-VW



Installation Instructions

REGISTERED DESIGN

Copyright Notice

The concepts, products and designs described in this document are the subject of international patents, and protected by international law. © Copyright Schneider Electric (Australia) Pty Ltd. All rights reserved.

Trademarks

Clipsal is a registered trademark of Schneider Electric (Australia) Pty Ltd.

'PDL by Schneider' is a registered trademark of Schneider Electric (NZ) Ltd.

Schneider Electric is a registered trademark of Schneider Electric (Australia) Pty Ltd.

Apple®, App StoreSM, iPhone®, iPod®, iPad®, MAC OS® and Safari® are brand names or registered trademarks of Apple Inc.

Google Play™ Store, Android™ and Google Chrome™ are brand names or registered trademarks of Google Inc.

All other logos and trademarks are the property of their respective owners.

Disclaimer

Schneider Electric (Australia) Pty Ltd reserves the right to change specifications or designs described in this manual without notice and without obligation.

Warnings

Read through the following instructions carefully and familiarise yourself with the device prior to installation, operation and maintenance. The warnings listed below can be found throughout the documentation and indicate potential risks and dangers or specific information that clarifies or simplifies a procedure.



The addition of this symbol to the “Danger” or “Warning” safety instructions indicates an electric danger that could result in serious injuries if the instructions are not followed.



This symbol presents a safety warning. It indicates a potential danger of personal injury. Follow all safety instructions with this symbol to avoid serious injuries or death.

DANGER

DANGER indicates an imminently hazardous situation that will inevitably result in serious or fatal injury if the instructions are not observed.

WARNING

WARNING indicates a possible danger that could result in death or serious injuries if it is not avoided.

CAUTION

CAUTION indicates a possible danger that could result in minor injuries if it is not avoided.

NOTICE

NOTICE provides information about procedures that do not represent the risk of any physical injury.

Table of Contents

1	For your Safety	6
2	Description	8
2.1	About ControlLink	8
2.2	Bluetooth Low Energy (BLE) Capability	8
2.3	Locking Bar	8
2.4	Combination Square/Phillips Drive Terminal Screws	8
2.5	Pushbutton Electronic Switch	9
2.6	Pushbutton Electronic Timer	9
2.7	Timeclock	10
2.8	More about Iconic Pushbutton Switches, Timers & Timeclocks	11
3	Features	12
3.1	Pushbutton Electronic Switch	12
3.2	Pushbutton Timer	12
3.3	Timeclock	12
4	Unit Operation	13
4.1	Pushbutton Electronic Switch	13
4.2	Pushbutton Timer/Timeclock	13
4.3	Timeclock-Specific Operations	14
4.4	LED Indicator	14
5	Configuration Mode	14
5.1	Configuration Presets for Pushbutton Electronic Switch	14
5.2	Configuration Presets for Pushbutton Timer/Timeclock (Switch Mode) 15	15
5.3	Configuration Presets for Pushbutton Timer/Timeclock (Timer Mode)	15
5.4	Exit Configuration Mode	15
6	Overload Protection Facilities	16
7	Load Compatibility	17
7.1	Important Notices for Iconic Pushbutton Electronic Switch, Timer & Timeclock	17
7.2	Load Compatibility Table	18
8	Incompatible Loads	20
8.1	Pushbutton Electronic Switch	20
8.2	Pushbutton Timer	20
8.3	Timeclock	20

9	Installation Requirements	20
9.1	Fitting the Mechanism to the Plate	21
9.2	Preparing and Fitting the Flush Box (when required)	21
9.3	Fitting the Plate	22
9.4	Fascia Installation and Removal	23
10	Wiring Diagrams	23
10.1	Connection Limitations	24
10.2	Overview	25
10.3	Terminal Blocks for 3-Wire 6 A Units	25
10.4	Cabling Diagrams: 2-Wire 350 W Units	26
10.5	Cabling Diagrams: 6 A Units	27
10.6	Cabling Diagrams: 10 A Units	28
10.7	Using the Iconic Smart Remote Mechanism	29
10.8	Wiring Diagram: Hot Water Service Booster Application (31VBER alternative)	29
10.9	Wiring Diagrams: Run-on Timer Application	30
10.10	Multi-Gang Derating	31
11	Wiser Room App	32
11.1	About the Wiser Room App	32
11.2	Download and Install the Wiser Room App	32
11.3	Pair Iconic Device with the App	33
11.4	Restore Point and Password	33
12	Electrical Specifications	34
12.1	Electrical Specification Notes	34
12.2	Electrical Specifications	34
13	Troubleshooting	35
13.1	Switches and Timers (2-Wire Units)	35
13.2	Troubleshooting Notes	35
14	Warranty	36

1 For your Safety

DANGER

HAZARD OF ELECTRIC SHOCK, EXPLOSION, OR ARC FLASH

- It is illegal for persons other than an appropriately licensed electrical contractors or other persons authorised by legislation to work on the fixed wiring of any electrical installation.
- To comply with all safety standards, the product must be used only for the purpose described in this instruction and must be installed in accordance with the wiring rules and regulation in the location where it is installed.
- There are no user serviceable parts inside the product.

Failure to follow these instructions will result in death or serious injury.

DANGER

HAZARD OF ELECTRIC SHOCK

The Locking Bar on Iconic plates must be set to the Closed position to ensure that the mechanism cannot be removed during normal operation.

Failure to follow these instructions will result in death or serious injury.

DANGER

RISK OF ELECTRIC SHOCK

- Hazardous voltage and electrical current may be present at the wire leads and outputs of this product even when the device is switched off.
- Lock out and tag the input circuit before accessing the wiring connections.

Failure to follow these instructions will result in death or serious injury.

WARNING

RISK OF USE IN SAFETY- AND LIFE-CRITICAL APPLICATIONS

- This product is intended for general lighting applications and small motor applications such as exhaust fans.
- Schneider Electric does not warrant or endorse this product for use in applications which are critical to the health or life of any human being.

Failure to follow these instructions can result in death or serious injury.

 **CAUTION****EQUIPMENT DAMAGE HAZARD**

- Install the device according to instructions in this document.
- Pay attention to the specifications and wiring diagrams related to the installation.
- Do not use this product for any other purpose than specified in this instruction.

Failure to follow these instructions can result in minor injuries, or equipment damage.

2 Description

The Iconic range includes a number of modular electronic switches, dimmers and timers/timeclocks incorporating advanced remote load control technology with Multi-Way dimming/switching capabilities.

The range also includes a selection of USB charging mechanisms.

Complementing the range are Wall Plates and Parts Packs (available separately) in various colours to suit many interior finishes.

2.1 About ControlLink

ControlLink is a technology, available only in the Iconic range, that makes it easier for installers to configure multi-way switching and dimming using standard electrical wiring techniques. Using a single control wire together with an Active wire, loads can be controlled remotely and timers triggered to allow run-on timing and similar applications.

2.2 Bluetooth Low Energy (BLE) Capability

BLE-enabled Iconic products can be configured and controlled via Bluetooth with the Wisier Room App installed on a compatible mobile device.

You can control the following Iconic products with the Wisier Room app:

- Pushbutton Electronic Switch with CTL and BLE (6AX 3-Wire)
- Pushbutton Timer with CTL and BLE (6AX 3-Wire)
- Pushbutton Timer with CTL and BLE (10AX 3-Wire)
- Time Clock with CTL, BLE and Pushbutton (6AX 3-Wire)
- Time Clock with CTL, BLE and Pushbutton (10AX 3-Wire)

Learn more about the Wisier Room app: *see "Wisier Room App" on page 32*

2.3 Locking Bar

Iconic mounting plates include a new patented locking bar feature to secure the mechanism body to the mounting plate. The mechanisms are easier to remove from the plate using this new mounting technique.

2.4 Combination Square/Phillips Drive Terminal Screws

On Iconic mechanisms with terminals, the terminal screws feature a combined Square Drive / Phillips Drive head, providing installers with the advantages of the Square Drive while retaining the commonality of the Phillips Drive.

2.5 Pushbutton Electronic Switch

Iconic Pushbutton Electronic Switches provide a robust mechanism for multi-way switching, with the added benefits of compatibility with a wide range of load types (depending on unit) and advanced protection features. Pushbutton Electronic Switches are available in two models.

Pushbutton Electronic Switch with ControlLink A 2-wire 350 W switch suitable for multi-way switching of dimmable and non-dimmable LED, Electronic Low Voltage lighting transformers, Iron-core low voltage lighting transformers and 240 V incandescent halogen lamps.

Pushbutton Electronic Switch 6 A with ControlLink and BLE A 3-wire 6 A switch suitable for multi-way switching of dimmable and non-dimmable LED, Electronic Low Voltage lighting transformers, Iron-core low voltage lighting transformers and 240 V incandescent halogen lamps, small motors (e.g. exhaust fans), heat lamps and contactors. This switch can be configured and controlled via the inbuilt pushbutton or via Bluetooth using the Wisier Room App installed on a compatible mobile device.

Both switch models feature multi-way switching capability, LED indicator and the ability to be remotely controlled with ControlLink.

2.6 Pushbutton Electronic Timer

Iconic Pushbutton Electronic Timers provide all the features of the Pushbutton Electronic Switch with the additional benefit of a timer mode. In this mode, the load is switched On when the inbuilt pushbutton (or pushbutton on another Iconic unit connected via the ControlLink terminal) is pressed. The load is switched Off once the configured time expires.

While a timer is counting down, the inbuilt LED Indicator flashes to indicate that the timer is in operation. The user can stop the timer and switch off the load by pressing either the inbuilt pushbutton or the pushbutton on any Iconic unit connected via ControlLink.

All Pushbutton Electronic Timer units offer a range of preset timer intervals from which the user can select via Configuration Mode using the inbuilt pushbutton. Higher-specification timer units also offer granular control over the timer interval via Bluetooth Low Energy (BLE) and the Wisier Room App installed on a compatible mobile device.

Pushbutton Electronic Timers are available in three models.

Pushbutton Electronic Timer with ControlLink A 2-wire 350 W timer switch suitable for multi-way switching / time-delay switching of dimmable and non-dimmable LED, Electronic Low Voltage lighting transformers, Iron-core low voltage lighting transformers and 240 V incandescent halogen lamps. This timer can be configured via the inbuilt pushbutton.

Pushbutton 6 A Timer with Controllink and BLE

A 3-wire 6 A timer switch suitable for multi-way switching / time-delay switching of dimmable and non-dimmable LED, Electronic Low Voltage lighting transformers, Iron-core low voltage lighting transformers and 240 V incandescent halogen lamps, small motors (e.g. exhaust fans), heat lamps, contactors and purely resistive loads. This timer can be configured and controlled via the inbuilt pushbutton and via Bluetooth with the Wiser Room App installed on a compatible mobile device.

This timer can also be configured as a fan run-on timer where a switched light signal can be connected to the ControlLink terminal to provide a re-triggerable exhaust fan control.

Pushbutton 10 A Timer with Controllink and BLE

A 3-wire 10 A timer that can be used for all loads compatible with the 6 A timer, but with a higher current rating. This timer can be configured and controlled via the inbuilt pushbutton and via Bluetooth with the Wiser Room App installed on a compatible mobile device.

2.7 Timeclock

Iconic Timeclocks offer the functionality of Pushbutton Timers, plus the ability to configure up to 16 time schedules that allow for:

- Days of the week (weekdays, weekends) and months of the year
- Sunrise/Sunset times that adjust based on geolocation.

All Timeclocks:

- are BLE-capable and can be configured/controlled via Bluetooth with the Wiser Room App installed on a compatible mobile device
- can maintain real-time settings (current time, date) for a minimum of 12 hours during a Mains power outage
- feature a configurable On/Off manual override pushbutton.

Timeclocks include Controllink remote control / triggering.

The 10 A Timeclock can be configured to operate as a Hot Water System Booster with a 15 A resistive rating, similar to the Clipsal 31VBER.

6 A Timeclock with Controllink and BLE

A 3-wire 6 A timeclock suitable for multi-way switching / time-delay switching of dimmable and non-dimmable LED, Electronic Low Voltage lighting transformers, Iron-core low voltage lighting transformers and 240 V incandescent halogen lamps, small motors (e.g. exhaust fans), heat lamps, contactors and purely resistive loads. Use where it is desirable to set time schedules for switching loads On and Off. This timeclock can be configured and controlled via the inbuilt pushbutton and via Bluetooth with the Wiser Room App installed on a compatible mobile device.

10 A Timeclock with ControlLink and BLE

A 3-wire 10 A timeclock that can be used for all loads compatible with the 6 A timeclock, but with a higher current rating. Use where it is desirable to set time schedules for switching loads On and Off, or as an alternative to a Hot Water System Booster where the additional functionality of the timeclock is desired. This timer can be configured and controlled via the inbuilt pushbutton and via Bluetooth with the Wiser Room App installed on a compatible mobile device.

2.8 More about Iconic Pushbutton Switches, Timers & Timeclocks

Iconic Pushbutton Switches, Timers and Timeclocks utilise powerful and sophisticated technology to provide full switching control of almost any type of load (depending on unit), whether it be dimmable LED* or non-dimmable LED, CFL lighting, mains voltage halogen or dichroic lamps, iron-core or electronic low voltage lighting transformers as used in downlight applications.

These products have also been specifically designed to handle energy efficient lighting.

All Iconic Pushbutton Switches, Timers and Timeclocks incorporate over-temperature protection. Iconic 2-wire 350 W units also incorporate over-current, over-voltage, short-circuit and thermal fuse protection. These features are designed to make the Iconic range of electronic switches, timers and timeclocks rugged, robust and reliable.

** Iconic pushbutton electronic switches, timers and timeclocks can **switch** dimmable LEDs but have no dimming capability. Select a Dimmer from the Iconic range if dimming of LEDs is required.*

3 Features

3.1 Pushbutton Electronic Switch

- Integrally switched pushbutton (tactile) control
- Suitable for multi-way switching
- ControlLink enabled for remote control
- Bluetooth Low Energy (BLE) support for configuration and control with the Wisser Room App installed on a compatible mobile device (6 A unit only)
- Inbuilt over-current, over-voltage, short-circuit and thermal fuse protection (2-wire 350 W unit only)
- Over-temperature protection
- LED indicator
- Suitable for switching a wide range of load types, including dimmable and non-dimmable LEDs
- Multi-gang capacity up to 6 mechanisms per plate (for 2-wire 350 W and 6 A units)
- Easy wiring using onboard integral terminals with unique combination Square Drive / Phillips Drive terminal screws (2-wire 350 W unit only)
- Wide range of plate and button colour variants available
- Complies with Australian and New Zealand electrical safety and EMC Standards.

3.2 Pushbutton Timer

All the features of the Pushbutton Electronic Switch, plus:

- Timer mode with configurable Timer function
- Bluetooth Low Energy (BLE) support for configuration and control with the Wisser Room App installed on a compatible mobile device (6 A / 10 A units only)
- Can be configured as a fan run-on timer (6 A / 10 A units only)
- Includes a Bell Press mode.

3.3 Timeclock

All the features of the Pushbutton Electronic Switch and Timer, plus:

- Up to 16 configurable time schedules
- Support for days of the week (weekdays and weekends) and months of the year
- Sunrise and sunset support with automatic adjustment for geolocation
- Can be configured for use as a Hot Water System Booster with a 15 A resistive rating (10 A unit only).

4 Unit Operation

4.1 Pushbutton Electronic Switch

Short Press **Switch**
Press the pushbutton to switch the load On or Off.

Extra Long Press (>15 s) **Configuration Mode**
If the pushbutton is pressed for more than 15 seconds, the load is switched Off and the unit enters Configuration Mode. (See Section 5)

4.2 Pushbutton Timer/Timeclock

Short Press **Switch Mode (configurable)**
Press the pushbutton to switch the load On or Off.

Timer Mode (default)

- When the load is Off, press the pushbutton to switch the load On and start the timer. The inbuilt LED Indicator flashes to indicate that the timer is operating. The load will switch Off once the timer expires.
- When the load is On and the timer is operating, press the pushbutton to switch the load Off and reset the timer.

Run-on Timer Mode

- When load is On in Run-on Timer mode, short press the pushbutton and the load connected to the pushbutton timer will delay Off based on the time set.

Scenarios

- **Scenario 1: Run-on Timer triggered from a light switch via controlLink.** When the light is switched On it turns the light and load connected to the pushbutton timer On. Short press the light switch again and it turns the light Off and the load connected to the pushbutton timer (Exhaust fan) will countdown to Off (Delay Off) based on the Time set via the Mobile Application. Default time is 5 Minutes
- **Scenario 2: Stand-alone Run-on timer switch.** Short press the pushbutton timer to turn Exhaust Fan On. Short press Pushbutton Timer again to start Timer countdown to Off based on Time Set via the Mobile Application
- **Overriding Timer:** When Run-on Timer mode is counting down based on time set or default time, a short press on the Pushbutton Timer will cancel the Load and turn fan Off.

Bell-press Mode

- The load is switched On while the pushbutton is pressed. Release pushbutton to switch the load Off.

Extra Long Press (>15 s) **Configuration Mode**
If pushbutton is pressed for more than 15 seconds, the load is switched Off and the unit enters Configuration Mode. (See Section 5.)

4.3 Timeclock-Specific Operations

Timeclock-specific configuration settings are only accessible via Bluetooth with the Wiser Room App installed on a compatible mobile device. Refer to the App User Guide and App Help for information on configuring Timeclock schedules.

4.4 LED Indicator

Iconic pushbutton units incorporate an LED Indicator. By default, the indicator displays at 100 % brightness when the load is switched On, and displays at 10 % brightness when the load is switched Off. To change the LED indicator configuration, refer to Section 5.

5 Configuration Mode

Iconic pushbutton switches, timers and timeclocks feature a number of Configuration Presets that can be selected via the inbuilt pushbutton. The Configuration Presets available in each Iconic product depend on the capabilities and features of that product.

Setting Configuration Mode

- ① Press and hold the pushbutton for at least 15 seconds.
- ② When the LED indicator starts flashing once every second, the unit has entered Configuration Mode with Configuration Preset 1 as the current selection.

Selecting a Configuration Preset

- ① Short Press the pushbutton to cycle through Configuration Presets.
- ② Observe the number of LED Indicator flashes (followed by a pause) to determine the current Preset selected.

For Example: 3 flashes then a pause indicates that Configuration Preset 3 is selected.

Refer to the “Configuration Presets” section for information about each Preset.

5.1 Configuration Presets for Pushbutton Electronic Switch

Preset Setting

- 1 Indicator settings (ON state: 100 %; OFF state: 10 %)
- 2 Indicator settings (ON state: 100 %; OFF state: 0 %)
- 3 Indicator settings (ON state: 0 %; OFF state: 0 %)
- 4 Factory Reset (BLE-capable units only)

5.2 Configuration Presets for Pushbutton Timer/Timeclock (Switch Mode)

Preset Setting

- 1 Indicator settings (ON state: 100 %; OFF state: 10 %)
- 2 Indicator settings (ON state: 100 %; OFF state: 0 %)
- 3 Indicator settings (ON state: 0 %; OFF state: 0 %)
- 4 Return unit to Timer Mode
- 5 Factory Reset (BLE-capable units only)

5.3 Configuration Presets for Pushbutton Timer/Timeclock (Timer Mode)

Preset Setting

- 1 Place unit in Switch Mode (infinite delay time)
- 2 Run-on timer (output remains On for 5 minutes after pushbutton is pressed from On state or Active is removed from ControlLink terminal)
- 3 Set timer delay to 30 seconds
- 4 Set timer delay to 1 minute
- 5 Set timer delay to 5 minutes
- 6 Set timer delay to 15 minutes
- 7 Set timer delay to 30 minutes
- 8 Set timer delay to 1 hour
- 9 Set timer delay to 2 hours
- 10 Set timer delay to 4 hours
- 11 Bell Press mode (output remains On while pushbutton is pressed or Active is applied to the ControlLink terminal)
- 12 Factory Reset (BLE-capable units only)

5.4 Exit Configuration Mode

If the pushbutton is pressed for more than 15 seconds whilst in Configuration Mode, the currently selected preset is stored and the device exits Configuration Mode (confirmed by the LED no longer flashing).

If more than 30 seconds elapse whilst in Configuration Mode without the pushbutton being pressed, the device exits Configuration Mode without storing any changes.

Note: Configuration settings are stored in non-volatile memory, meaning that they will be retained if Mains power is lost to the unit.

6 Overload Protection Facilities

The Iconic range has a number of sophisticated protection mechanisms (depending on unit) to reduce the risk of damage in the case of abnormal operating conditions.

Over-temperature Protection All Iconic Pushbutton Switches, Timers and Timeclocks incorporate Over-temperature Protection whereby the load is switched Off should the unit be inadvertently exposed to over-temperature conditions. The Over-temperature Protection resets automatically once over-temperature conditions are corrected.

Thermal Fuse, Over-current and Short Circuit Protection Iconic 2-wire 350 W Switches and Timers incorporate the following levels of protection:

Thermal Fuse

Iconic 2-wire units contain a non-resettable thermal fuse device designed to blow in case of catastrophic failure. This is an extreme protection measure intended to operate as a backup in case of persistent or prolonged overload conditions.

If the thermal cut-out fuse blows, the unit will be rendered permanently inoperable and must be replaced.

Note: The thermal fuse device is not replaceable by the user.

Any significant overload or exposure to high ambient operating temperatures should be avoided in order to prevent permanent damage to the unit.

Over-current and Short Circuit Protection

Iconic 2-wire 350 W units feature over-current, over-voltage and short circuit protection capabilities, designed to protect the unit under most abnormal operating conditions. This ensures the unit can survive in case of wiring fault, or catastrophic failure of the load.

The short circuit protection mechanism resets automatically once the short circuit condition is removed.

7 Load Compatibility

7.1 Important Notices for Iconic Pushbutton Electronic Switch, Timer & Timeclock

NOTICE

EQUIPMENT DAMAGE HAZARD (LOAD AND OPERATION)

- Operation of Iconic units at elevated temperatures or voltages outside of specification (240 V AC and 25 °C) may cause the over-temperature protection circuitry to operate. Operating Iconic 2-wire units with significant overload may cause the thermal fuse to blow and render the unit inoperable.
- Reduce the size of the connected load or use a different brand of lamp to prevent reoccurrence.
- Do not operate the product for prolonged periods in extreme conditions.

Failure to follow these instructions can result in equipment damage.

NOTICE

RISK OF ABNORMAL OPERATION OR REDUCED PERFORMANCE

- Do not connect mixed load types to either the 2-wire 350 W Pushbutton Electronic Switch or the 2-wire 350 W Pushbutton Timer. Use the 3-wire 6 A electronic switch for mixed loads.
- The 2-wire 350 W Pushbutton Electronic Switch has a 10 W minimum load. When connecting loads that are sensitive to low leakage currents, fit a 31LCDA Load Correction Device to reduce the possibility of an unstable 'off' state.
- Use the 3-wire Pushbutton Electronic Switch 6 A, Pushbutton 6 A/10 A Timer or Pushbutton 6 A/10 A Timeclock for small motor loads (e.g. exhaust fans).
- For 2-wire electronic switches and timers, use only iron-core transformers as recommended by the manufacturer.
- Use only the Pushbutton 10 A Timeclock for Hot Water System Booster application.









Failure to follow these instructions can result in abnormal equipment operation or reduced equipment performance.

NOTICE**MAXIMUM LOAD RATINGS APPLY**



Ensure that the number of Low Voltage Lighting Transformers connected to a single Pushbutton Electronic Switch, Timer or Timeclock does not exceed the maximum load rating of the unit.







Failure to follow these instructions can result in equipment malfunction.

7.2 Load Compatibility Table**Pushbutton Electronic Switch**











Load Symbol	Compatible Loads	2-wire Switch	6 A Switch
	LED Lighting	350 W (Dimmable) 250 W (Non-Dim.)	6 A
	Incandescent Lighting MV Halogen / Dichroic Lamps	350 W	6 A
	Low voltage halogen / dichroic lighting with electronic transformers	350 W	6 A
	Low voltage halogen / dichroic lighting with iron-core transformers	350 W	6 A
	Linear Fluorescent Lamps	250 W	6 A
	Compact Fluorescent Lamps	250 W	6 A
	Inductive Loads	Not Compatible	6 A @ 0.8 Power Factor
	Contactors	Not Compatible	6 A
	Purely Resistive Loads	350 W	6 A

Pushbutton Timer

Load Symbol	Compatible Loads	2-wire Timer	6 A Timer	10 A Timer
	LED Lighting	350 W (Dimmable) 250 W (Non-Dim.)	6 A	10 A
	Incandescent Lighting MV Halogen / Dichroic Lamps	350 W	6 A	10 A

Load Symbol	Compatible Loads	2-wire Timer	6 A Timer	10 A Timer
	Low voltage halogen / dichroic lighting with electronic transformers	350 W	6 A	10 A
	Low voltage halogen / dichroic lighting with iron-core transformers	350 W	6 A	10 A
	Linear Fluorescent Lamps	250 W	6 A	10 A
	Compact Fluorescent Lamps	250 W	6 A	10 A
	Inductive Loads	Not Compatible	6 A @ 0.8 Power Factor	10 A @ 0.8 Power Factor
	Contactors	Not Compatible	6 A	10 A
	Purely Resistive Loads	350 W	6 A	15 A

Timeclock

Load Symbol	Compatible Loads	6 A Timeclock	10 A Timeclock
	LED Lighting	6 A	10 A
	Incandescent Lighting	6 A	10 A
	MV Halogen / Dichroic Lamps	6 A	10 A
	Low voltage halogen / dichroic lighting with electronic transformers	6 A	10 A
	Low voltage halogen / dichroic lighting with iron-core transformers	6 A	10 A
	Linear Fluorescent Lamps	6 A	10 A
	Compact Fluorescent Lamps	6 A	10 A
	Inductive Loads	6 A @ 0.8 Power Factor	10 A @ 0.8 Power Factor
	Contactors	6 A	10 A
	Purely Resistive Loads	6 A	15 A

8 Incompatible Loads

8.1 Pushbutton Electronic Switch

The 2-wire 350 W Pushbutton Electronic Switch described in this instruction is not compatible for use with motor loads. Use the Pushbutton Electronic 6 A Switch for small motor loads.

Iconic Pushbutton Electronic Switches do not have dimming capability. Use one of the Dimmer products in the Iconic range for dimming applications.

8.2 Pushbutton Timer

The 2-wire 350 W Pushbutton Timer described in this instruction is not compatible for use with motor loads. Use the Pushbutton Electronic 6 A Timer or 10 A Timer for small motor loads.

Iconic Pushbutton Timers do not have dimming capability. Use one of the Dimmer products in the Iconic range for dimming applications.

8.3 Timeclock

Iconic Timeclocks do not have dimming capability. Use one of the Dimmer products in the Iconic range for dimming applications.

9 Installation Requirements

DANGER

HAZARD OF ELECTRIC SHOCK

The Locking Bar on Iconic plates must be set to the Closed position to ensure that the mechanism cannot be removed during normal operation.

Failure to follow these instructions will result in death or serious injury.

DANGER

RISK OF ELECTRIC SHOCK

- Hazardous voltage and electrical current may be present at the wire leads and outputs of this product even when the device is switched off.
- Lock out and tag the input circuit before accessing the wiring connections.

Failure to follow these instructions will result in death or serious injury.

9.1 Fitting the Mechanism to the Plate

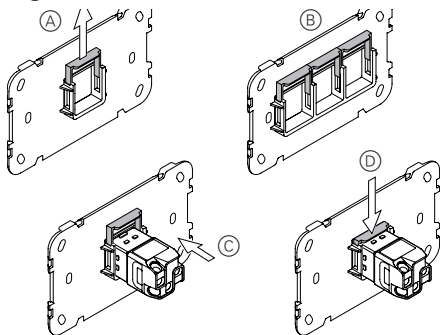

- ① On the plate, move the locking bar (A) to the Open position.
Note: On multi-gang plates, the locking bar is a single piece covering all cutouts (B).
- ② Push the head of the mechanism into the plate cutout (C) until the mechanism clicks into place.
- ③ Once the mechanism is installed in the plate (or all mechanisms for multi-gang plates), move the locking bar to the Closed position (D).

9.2 Preparing and Fitting the Flush Box (when required)

When **10 A** mechanisms are to be fitted to certain flush boxes (New Zealand installations), there may be a need to modify the flush box to accommodate the mechanism body.

For installations that have a flush box with a back section, this back section will need to be removed to accommodate the depth of the mechanism so that the plate the mechanism is inserted into can be fixed flush to the wall.

9.3 Fitting the Plate

2-wire 350 W and 3-wire 6 A Units

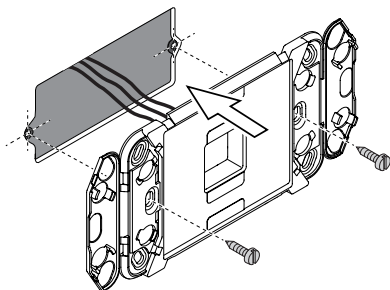
**NOTICE**

Allow a minimum **35 mm** depth in the wallbox / wall cavity to recess mechanisms and wiring.

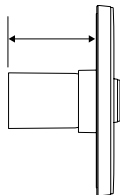

3-wire 10 A Units

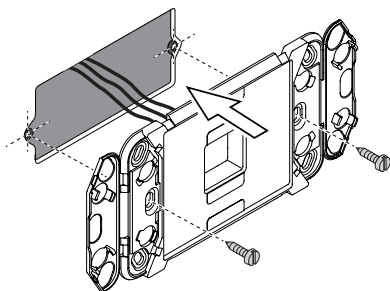
**NOTICE**

Allow a minimum **70 mm** depth in the wallbox / wall cavity to recess mechanisms and wiring.

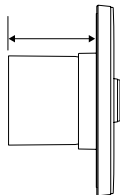

9.4 Fascia Installation and Removal

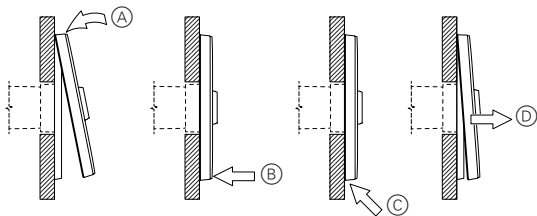

Installation

- ① Place the upper section of the fascia against the upper section of the plate, as shown in (A).
- ② Apply pressure to the bottom section of the fascia (B) so that the fascia “snaps in” to the plate.

Removal

- ① Insert the flat tip of a plastic tool into one of the slots located at the centre of the long edges of the fascia (C).
- ② Gently prise the fascia edge away from the plate (D) until the clips release the fascia.

10 Wiring Diagrams

DANGER

HAZARD OF ELECTRIC SHOCK, EXPLOSION, OR ARC FLASH

- It is illegal for persons other than an appropriately licensed electrical contractors or other persons authorised by legislation to work on the fixed wiring of any electrical installation.
- To comply with all safety standards, the product must be used only for the purpose described in this instruction and must be installed in accordance with the wiring rules and regulation in the location where it is installed.
- There are no user serviceable parts inside the product.

Failure to follow these instructions will result in death or serious injury.

  **DANGER****RISK OF ELECTRIC SHOCK**

- Hazardous voltage and electrical current may be present at the wire leads and outputs of this product even when the device is switched off.
- Lock out and tag the input circuit before accessing the wiring connections.

Failure to follow these instructions will result in death or serious injury.

 **WARNING****RISK OF USE IN SAFETY- AND LIFE-CRITICAL APPLICATIONS**

- This product is intended for general lighting applications and small motor applications such as exhaust fans.
- Schneider Electric does not warrant or endorse this product for use in applications which are critical to the health or life of any human being.

Failure to follow these instructions can result in death or serious injury.

*NOTICE***RISK OF EQUIPMENT DAMAGE OR MALFUNCTION (WIRING CONNECTIONS)**

To avoid damaging the equipment and possibly voiding the warranty:

- Do not connect multiple Primary Units in parallel, or connect one Primary Unit to another Primary Unit—connect Remote Units to the Primary Unit via ControlLink for Multi-Way control.
- Do not connect a Remote Unit to the load.
- Always wire Remote Units to the same circuit and phase as the Primary Unit.
- Test operation during installation and correct any wiring errors immediately.
- Keep cable insulation away from the sides of the enclosure to avoid possible damage or long term degradation of the cable insulation.

Failure to follow these instructions can result in equipment damage or malfunction.

10.1 Connection Limitations

ControlLink-enabled devices can be connected to a single Primary Unit, allowing remote switching of the load. A maximum total cable length of 30 metres is permitted

10.2 Overview

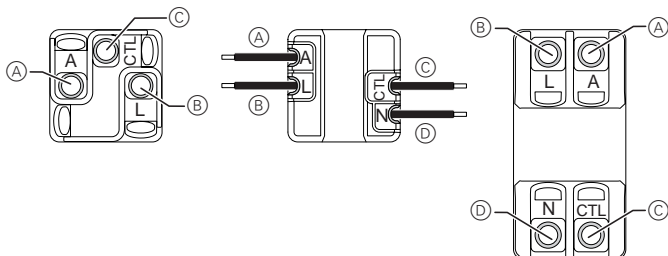

- (A) Active
- (B) Load
- (C) ControlLink Terminal
- (D) Neutral (6 A/10 A units only)

About the ControlLink Terminal

Connect a standard 1.5 mm² cable between the ControlLink terminals of a Pushbutton Electronic Switch/Timer/Timeclock and other ControlLink-enabled Iconic units to provide multi-way switching.

10.3 Terminal Blocks for 3-Wire 6 A Units

Example Diagram

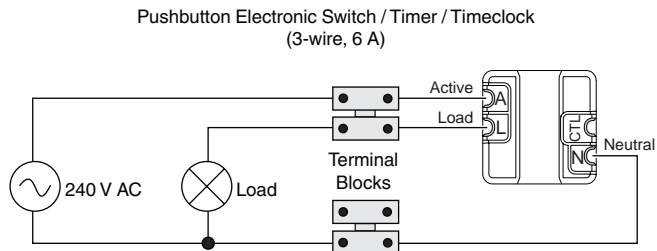

Use the terminal blocks supplied with 3-wire 6 A units to connect the mechanism to the circuit. After wiring, wrap the terminal blocks with insulating tape.

10.4 Cabling Diagrams: 2-Wire 350 W Units

1x Pushbutton Electronic Switch or Timer (2-wire)

+ Optional 1x ControlLink Pushbutton for two-way application. (See also: section 10.7 on p29)

+ Optional additional 1x ControlLink Pushbutton for three-way application.

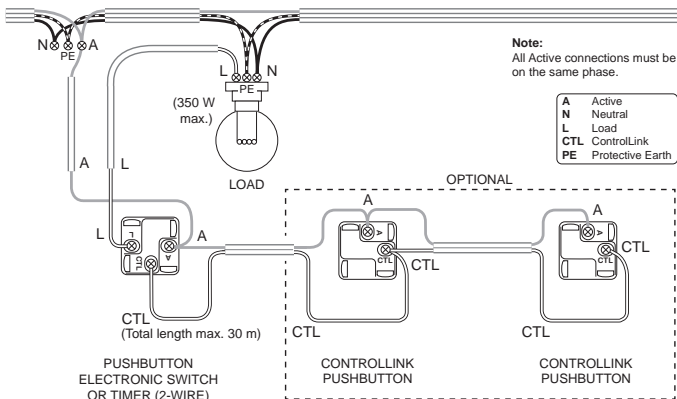

2x Pushbutton Electronic Switch or Timer (2-wire)

+ Optional additional 1x Pushbutton Electronic Switch or Timer (2-wire) for two-way application.

+ Optional 1x ControlLink Pushbutton for three-way application. (See also: section 10.7 on p29)

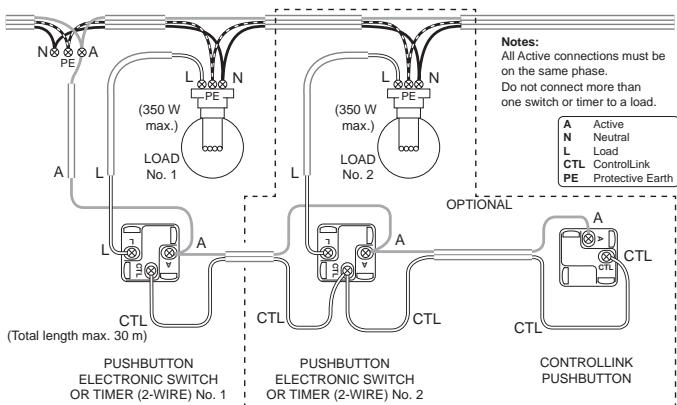

10.5 Cabling Diagrams: 6 A Units

1x Pushbutton Electronic Switch/Timer/Timeclock (6 A)

+ Optional 1x ControlLink Pushbutton for two-way application. (See also: section 10.7 on p29)

+ Optional additional 1x ControlLink Pushbutton for three-way application.

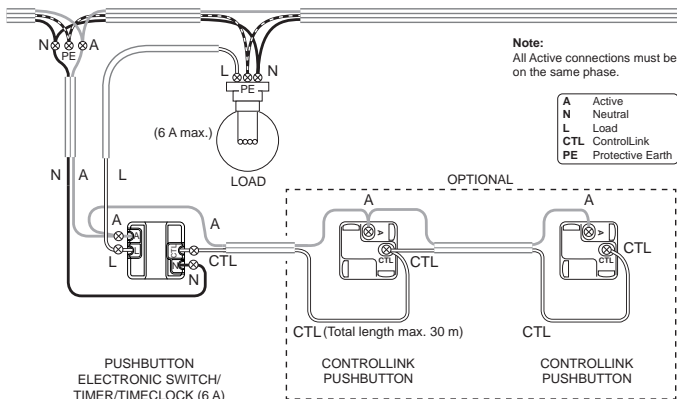

2x Pushbutton Electronic Switch/Timer/Timeclock (6 A)

+ Optional additional 1x Electronic Switch/Timer/Timeclock (6 A) for two-way application.

+ Optional 1x ControlLink Pushbutton for three-way application. (See also: section 10.7 on p29)

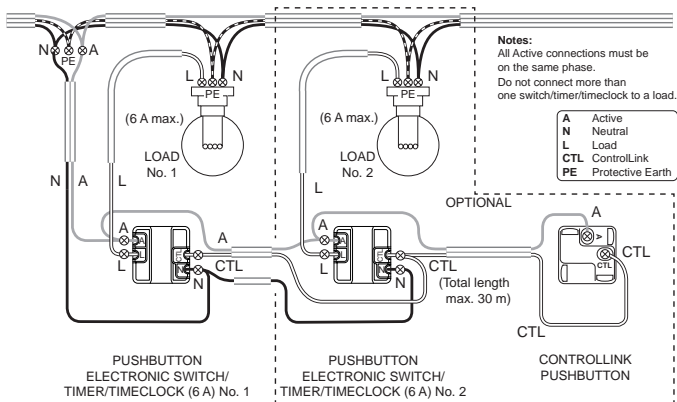

10.6 Cabling Diagrams: 10 A Units

1x Pushbutton Electronic Timer/Timeclock (10 A)

+ Optional 1x ControlLink Pushbutton for two-way application. (See also: section 10.7 on p29)

+ Optional additional 1x ControlLink Pushbutton for three-way application.

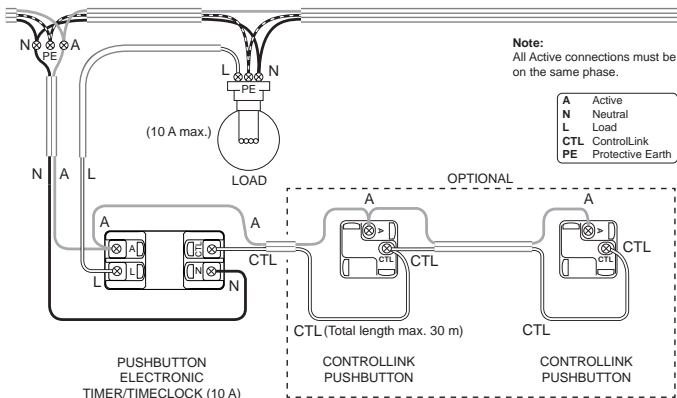

2x Pushbutton Electronic Timer/Timeclock (10 A)

+ Optional additional 1x Pushbutton Electronic Timer/Timeclock (10 A) for two-way application.

+ Optional 1x ControlLink Pushbutton for three-way application. (See also: section 10.7 on p29)

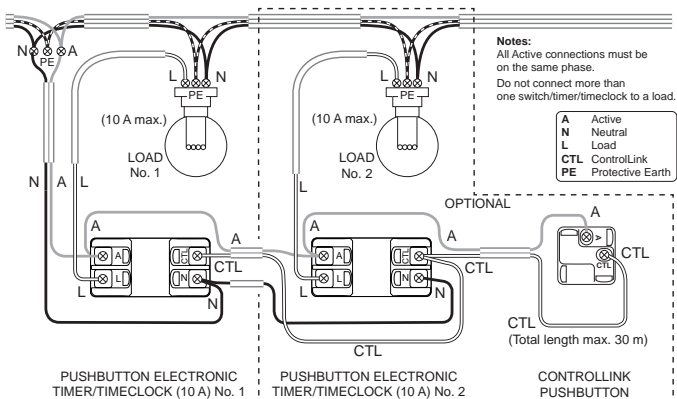

10.7 Using the Iconic Smart Remote Mechanism

The Iconic Smart Remote Mechanism (41EPBCLM-VW / PDL356PBSSL-VW) is a 3-wire version of the optional ControlLink Pushbutton shown in the diagrams in sections 10.4 to 10.6.

The Iconic Smart Remote Mechanism is compatible with Iconic Pushbutton Switches, Timers and Timeclocks. It also includes an LED indicator that can be configured to match the behaviour of the primary mechanism LED indicator.

NOTICE

The Iconic Smart Remote mechanism requires a Neutral connection.

10.8 Wiring Diagram: Hot Water Service Booster Application (31VBER alternative)

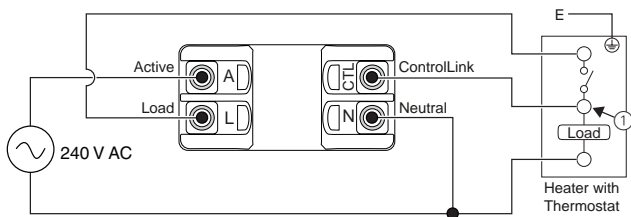

① This connection must be on the load side of the thermostat

10.9 Wiring Diagrams: Run-on Timer Application

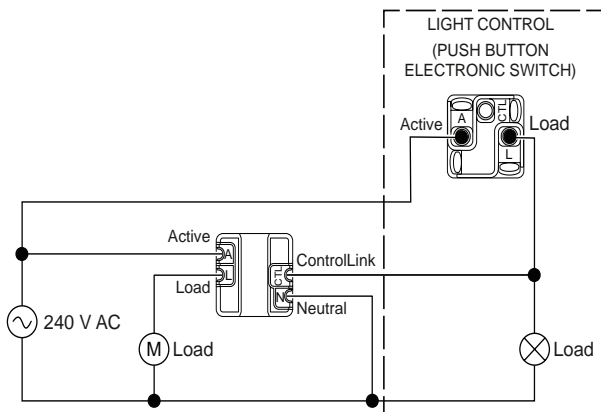
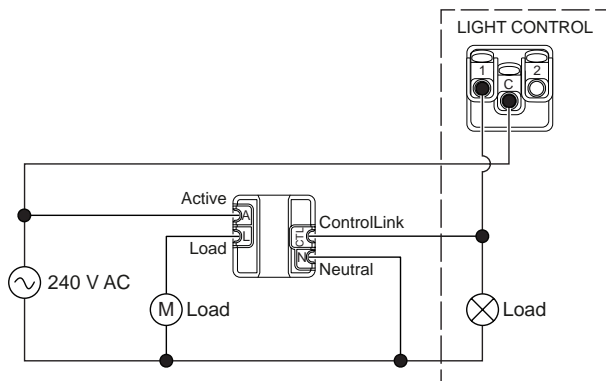

10.10 Multi-Gang Derating

For applications where Iconic Pushbutton Electronic Switches, Timers and Timeclocks are multi-ganged, derate the maximum load rating of each unit according to the derating table shown below.

NOTICE

The load figures shown below are based on a nominal voltage of 220-240 V AC.

Primary Mechanisms per Plate	Max. Load per Primary Mechanism		
	(2-Wire Units)	(6 A Units)	(10 A Units)
1	350 W	6 A	10 A
2	250 W	4.5 A	7.5 A
3	220 W	4 A	6.5 A
4	175 W	3 A	N/A
5	120 W	2 A	N/A
6	100 W	1.5 A	N/A

NOTICE

Only Primary Units need be derated. Multi-Way Remote Units on the same plate can be ignored for the purpose of multi-gang derating.

11 Wisier Room App

11.1 About the Wisier Room App

You can operate BLE-enabled Iconic devices with BLE-enabled smart devices (tablet or smartphone) via the Wisier Room app. You can also change the modes and and set other values. To do this, you need to do the following:

- Download and Install the Wisier Room app
- Pair Iconic devices with the Wisier Room app

11.2 Download and Install the Wisier Room App

System Requirements

The Wisier Room app was developed for smart devices such as smartphones and tablets and is available for the Apple® iOS and Android™ operating systems. Due to the large number of smart devices available on the market, compatibility cannot be guaranteed. The smart device must fulfil the following minimum technical requirements:

Android™	Version 4.4 or higher
Apple®	iOS 9.1 or higher
Bluetooth interface	Bluetooth Smart Ready V4.1 or higher

- ① Download the Wisier Room app from the related Store (-> see QR code)
- ② Install the Wisier Room app on you smart device.

QR code, Wisier Room app for Android



<https://play.google.com/store/search?q=WISER%20ROOM%20Schneider>

QR code, Wisier Room app for Apple (AUS)



<https://itunes.apple.com/au/app/clipsal-wisier-room/id1108235073?mt=8>

QR code, Wisier Room app for Apple (PDL NZ)



<https://itunes.apple.com/nz/app/pdl-wisier-room/id1154348627?ls=1&mt=8>

11.3 Pair Iconic Device with the App

NOTICE

For pairing the device, you must be in its Bluetooth range (max. 10 m) with your smart device.

The number of connections between Iconic devices and the app is limited: per Iconic device you can connect max. 8 smart devices (for more information -> see the Wiser Room app Help).

Establish a Bluetooth connection and add devices

- ① Activate the bluetooth connection in the settings of your smart device and open the app.
- ② Tap on **Edit** in the top right corner of the overview screen **My devices** in the app.

Follow the instructions in the app:

- ③ Tap on **Add new device**
- ④ Press the button on your Iconic device **4x**.
Only for Android smart devices: The specific Bluetooth address of the Iconic device will be shown and used for identification.
- ⑤ Set the mode for the Iconic device by following the wizard.

NOTICE

If you want to change the mode after the original setup with the Wiser Room app, you need to perform a physical factory reset (see **"Configuration Mode" on page 14**) before continuing with the next steps.

- ⑥ Choose a device name and a room name. Rooms that are already created in the app will appear as suggestions.
- ⑦ Choose an icon for the Iconic device to help identify the device easily.
- ⑧ Tap on **Done** to add the device to your dashboard.

The app is now paired and connected with the Iconic device. The paired Iconic device appears in your device list. Each new bluetooth connection is established automatically when you access the Iconic device in the app.

11.4 Restore Point and Password

Create a restore point to save a defined set of settings. This restore point can be used as fall-back level in case you apply changes which are not suitable for the device and it's use. Within the creation of a restore point the app will ask for a password. The password is: 1 2 3 4

NOTICE

This password cannot be changed. You will find more information and help in the Wiser Room app Help.

12 Electrical Specifications

12.1 Electrical Specification Notes

- Specifications typical @ 240 V AC, 25 °C
- Suitable for indoor use only
- No user-serviceable parts inside.

12.2 Electrical Specifications

Parameter	2-wire 350 W Units	3-wire 6 A Units	3-wire 10 A Units
Nominal Operating Voltage	220–240 V AC		
Nominal Operating Frequency	50 Hz		
Maximum Load Rating	350 W	6 A	10 A
Switching Technique	Semiconductor	Relay	Relay
Wiring Configuration:			
Incandescent Loads	350 W	6 A	10 A
MV Halogen Loads	350 W	6 A	10 A
Electronic LV Lighting Transformers	350 W	6 A	10 A
Iron Core LV Lighting Transformers (EI and Toroidal Types)	350 W	6 A	10 A
Linear Fluorescent Ballasts	250 W	6 A	10 A
Compact Fluorescent Loads	250 W	6 A	10 A
LED Lighting Drivers	350 W (Dimmable) 250 W (Non-Dim.)	6 A	10 A
Inductive Loads (e.g. Small Motors such as Ceiling Exhaust Fans)	Not Compatible	6 A @ 0.8 Power Factor	10 A @ 0.8 Power Factor
Purely Resistive Loads	350 W	6 A	15 A
Voltage / Frequency Stability	YES		
Over-current / Thermal Fuse Protection	YES	NO	NO
Over-temperature Protection	YES		
Short Circuit Protection	YES	NO	NO
BLE-enabled	NO	YES	YES
LED Indicator	YES		
Multi-Way Control	YES		

Parameter	2-wire 350 W Units	3-wire 6 A Units	3-wire 10 A Units
Multi-Gang Plate Capacity	Max. 6 Primary Mechanisms per Plate, Combinations Allowed, Derating to be applied (refer to section 'Multi-Gang Derating')		Max. 3 Primary Mechanisms per Plate, Combinations Allowed, Derating to be applied (refer to section 'Multi-Gang Derating')
Available Plate / Control Styles	Iconic Style, Standard and Architrave Options, Colour Packs for Pushbutton Caps and Plates: Vivid White (VW), Warm Grey (WY), Cool Grey (CY), Anthracite (AN)		
Mounting Centres	84 mm Australian Pattern Plate		
Safety Compliances	AS/NZS 60669.2.1		
EMC Emission Compliance	AS/NZS 60669.2.1		

13 Troubleshooting

13.1 Switches and Timers (2-Wire Units)

Problem

The LED load is glowing in the Off state and/or occasionally flickering when on.

Recommended Resolution

Iconic 2-wire Electronic Switches and Timers are designed to work with Clipsal LED loads.

If other LED loads are used and the described problem occurs, try the following remedies:

- Install a Clipsal 31LCDA load correction device across the load for improved performance.

13.2 Troubleshooting Notes

Note: Iconic Pushbutton Electronic Switches, Timers and Timeclocks are not suitable for dimming applications—select a Dimmer from the Iconic range for this purpose.

- Ensure to use Iconic 3-wire products on non-dimmable or non-lighting loads (such as small motors).
- Contact Customer Care (see last page) for further guidance if issues persist.

14 Warranty

Schneider Electric (Australia) Pty Ltd, (Clipsal by Schneider Electric), warrants this product to be free from defects in materials and workmanship for a period of two years from the date of installation. The benefits conferred herein are in addition to any other rights and remedies you may have at law in respect to this product. Australian and New Zealand customers please see the notes below.

Australia

Australian Consumer Law specifies that our goods come with guarantees that cannot be excluded. You are entitled to a replacement or refund for a major failure and compensation for any other reasonably foreseeable loss or damage. You are also entitled to have the goods repaired or replaced if the goods fail to be of acceptable quality and the failure does not amount to a major failure.

New Zealand

This guarantee is in addition to and does not affect your rights under applicable law, except where that law expressly provides otherwise. The Consumer Guarantee Act 1993 (NZ) will not apply if this product is purchased for the purpose of business.

This warranty is expressly subject to the Schneider Electric product being installed, wired, tested, operated and used in accordance with our instructions and specifications. Any alterations or modifications made to the product without our permission will void the warranty. Schneider Electric will at its option repair, replace or refund any defective product. The cost of replacement or repair of a defective product is limited to the price of the product only. Schneider Electric will not be responsible for the cost of retrieving, removing, reinstalling, transporting (including return of the defective product to us) or re-testing a product.

How to make a claim: You shall provide Schneider Electric with adequate particulars of the defect within 28 days of the fault occurring. Contact your local Schneider Electric, PDL or Clipsal products' supplier and provide the details of the date of purchase, description of load or connections and the circumstances of the failure. Returned products must be securely packed and labelled for proper processing.

CLIPSAL

by Schneider Electric

Australia

Schneider Electric (Australia) Pty Ltd

Customer Care Australia:

1300 369 233

Email:

customercare.au@schneider-electric.com

www.schneider-electric.com.au



by Schneider Electric

New Zealand

Schneider Electric (NZ) Ltd

38 Business Parade South, Highbrook,

East Tamaki, Manukau 2013

P.O. Box 259370 Botany, Manukau 2163

Telephone +64 9-829 0490

Fax +64 9-829 0491

After hours service hotline:

0800 735 4357 (New Zealand only)

Customer Care: 0800 652 999

Email: sales@nz.schneider-electric.com

www.pdl.co.nz/iconic

Schneider Electric reserves the right to change specifications, modify designs and discontinue items without incurring obligation and whilst every effort is made to ensure that descriptions, specifications and other information in this catalogue are correct, no warranty is given in respect thereof and the company shall not be liable for any error therein.

© Schneider Electric 2018

This material is copyright under Australian, New Zealand and international laws. Except as permitted under the relevant law, no part of this work may be reproduced by any process without prior written permission of and acknowledgement to Schneider Electric.