



MAX9™

The ultimate in circuit protection

CLIPSAL®

Lead the way with latest innovation
in circuit protection.

clipsal.com/MAX9

Life Is 

Schneider
 Electric



About MAX9 range

Innovation in electrical safety

Since 1920, Clipsal has been helping to make Australian homes safer by supplying customers with the most innovative and sustainable electrical solutions available on the market. Clipsal was one of the pioneers of bringing miniature version of RCD (also known as 'Safety switch') to Australian market under 4 Series.

MAX9 range is the next generation of circuit protection, but the mission remains unchanged. MAX9 range raises the bar in circuit protection with MAXBAR.

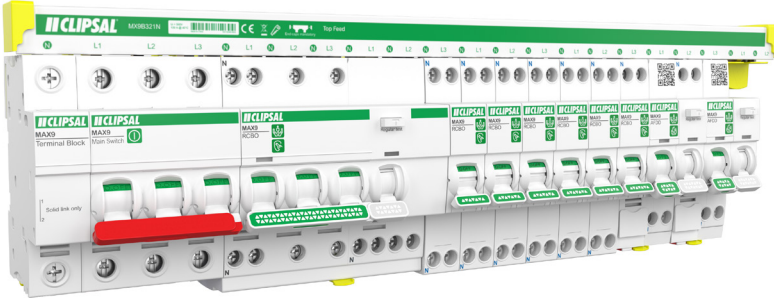

MAX PROFESSIONAL
No cables for feeding RCBOs

MAX SPEED
Up to 15 times faster installation speed
Compared to connecting with cables

MAX PERFORMANCE
100A rated system

MAX FLEXIBILITY
One busbar connects to main switch, all type of Clipsal RCBOs and AFDD

Clipsal MAX9 – The ultimate in circuit protection for MAX Generation

The Clipsal MAX9 range is designed to provide maximum efficiency and peace of mind to electricians, so that you can focus on growing your business and providing best service to your customers with latest innovation in circuit protection.

Introducing MAXBAR – The next generation busbar

MAX9 takes the definition of a busbar to next level with MAXBAR. MAXBAR is nothing like ordinary busbars, it helps to improve your installation speed by up to 15 times when compared to traditional wiring method. With MAXBAR, you don't need any cable connections to feed final sub-circuits protected by an RCBO or AFDD - it picks up the active feed from main switch and distributes both active & neutral across the RCBOs and AFDDs. MAXBAR helps to connect main switch to all types of Clipsal RCBOs - SLIM RCBO, 2 module RCBO or a 3P+N RCBO.



Open up business growth opportunities with latest innovation

MAX9 range helps to open up new business growth opportunities with latest innovations like Arc Fault Detection Device (AFDD) and Energy Management by Wiser. AFDD is next generation of circuit protection device to help keep Australian homes safe from electrical fires caused by arc faults. AFDDs help to safeguard against electrical fires by detecting even the smallest electrical arcs caused by cable or electrical contact damage and disconnect power before the resulting heat starts a fire.

Energy takes up a significant portion of every household budget. Tracking its usage is tricky, but essential to identifying inefficiencies and reducing the amount a home owner spends on energy bills. That's where Energy Management by Wiser™ comes in. **Energy Management by Wiser helps to convert a standard switchboard into a connected switchboard with PowerTags.** It gives 24/7 visibility into a home's energy consumption and production. Using the Wiser App together with connected Wiser devices installed into a switchboard, help your customers keep track of their electrical circuits, maximise solar performance, set a budget and save on electricity bills.



AFDD



What's new in residential circuit protection?

Enjoy peace of mind with MAX9

We understand sometimes it can be very hard to stay on top of all the regulation and standard changes. We have taken all that stress out for circuit protection with MAX9 range. The complete MAX9 system is type tested to AS/NZS 61439-3, so you don't have to think twice about compliance to this standard if you use complete MAX9 system. All the RCDs and RCBOs in MAX9 range are Type A and hence future ready for the requirements of Amendment 2 to AS/NZS 3000:2018 (Known as "Wiring Rules").

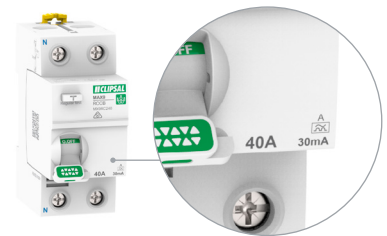

Performance that MAX9 Generation deserves

MAX9 system is designed to provide maximum performance to the MAX Generation with 100A rated system. MAXBAR and all MAX9 enclosures are designed to withstand 100A current. MAX9 range is built for tough Australian conditions. All MAX9 devices have operating temperature range from -25 Deg C to +70 Deg C with derating.



Best in-class quality is a given for Clipsal products but MAX9 range takes it to the next level. MAX9 devices are designed to last 20,000 mechanical cycles and 10,000 electrical cycles. This can only be achieved with a robust design and precision in manufacturing process. This MAX performance and MAX quality helps us to provide you additional peace of mind with a 7-year warranty on MAX9 products.

Simplify safety

MAX9 range also brings in lot of simplicity in your life. Sometimes it might be a bit hard to explain different types of circuit protection to home owner. We have made this very simple with Pictograms on all our products to make it easy to explain the functionality of RCDs, MCBs, RCBOs, SPDs and AFDDs.



Surge protection



Fire protection



Cable protection



People protection



Isolator switch

We have also made it simple to access all the product information like specifications, installation instructions, brochures, etc. - just scan the QR code on the product with a mobile device and all the information will be at your finger-tips.

QR CODE

Simply scan QR code for all product info – specs, brochures, installation instructions, etc.





Green Premium

An industry leading portfolio of offers delivering sustainable value



More than 75% of our product sales offer superior transparency on the material content, regulatory information and environmental impact of our products:

- RoHS compliance
- REACH substance information
- Industry leading # of PEP's*
- Circularity instructions



Discover what we mean by green

[Check your products!](#)

The Green Premium program stands for our commitment to deliver customer valued sustainable performance. It has been upgraded with recognized environmental claims and extended to cover all offers including products, services and solutions.

[CO₂ and P&L impact through... Resource performance](#)

Green Premium brings improved resource efficiency throughout an asset's lifecycle. This includes efficient use of energy and natural resources, along with the minimization of CO₂ emissions.

[Cost of ownership optimization through... Circular performance](#)

We're helping our customers optimize the total cost of ownership of their assets. To do this, we provide IoT-enabled solutions, as well as upgrade, repair, retrofit, and remanufacture services.

[Peace of mind through... Well-being performance](#)

Green Premium products are RoHS and REACH compliant. We're going beyond regulatory compliance with step-by-step substitution of certain materials and substances from our products.

[Improved sales through... Differentiation](#)

Green Premium delivers strong value propositions through third-party labels and services. By collaborating with third-party organizations we can support our customers in meeting their sustainability goals such as green building certifications.

*PEP: Product Environmental Profile (i.e. Environmental Product Declaration)

3 simple steps to MAX electrical protection for your customers

Step 1: RCBO – Residual current device (RCD) & Miniature Circuit Breaker (MCB) combo – 1 device helps to protect people as well as electrical cables

The famous Clipsal RCD (also known as 'Safety Switch') is an absolute must for every home. In fact, it is a legal requirement for all new homes in Australia to have RCD protection for all final sub-circuits. Why? Because in the case of faulty appliances or wiring, this little device in your switchboard will help to disconnect power and help to save your loved ones from a potentially fatal electric shock.

Electrical cables can get extremely hot due to overload and short circuit and potentially damage your home due to electrical fires. To help protect cables from damage, you need to have MCB installed at the switchboard.

Instead of having a separate MCB and RCD for each circuit, make the smart choice with Clipsal SLIM RCBO. This is a combo device that will provide RCD & MCB functions in 1 device and save valuable space in your switchboard.

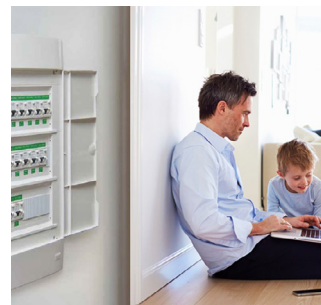

Step 2: Surge Protection – Helps to protect your electrical appliances

Lightning strikes, power surges and voltage spikes are nasty and can destroy your electronic equipment in an instant. You've invested a lot of money in your appliances. Just imagine discovering your big-screen TV, audio system or coffee machine, fried and irreparable... It just isn't worth the risk. Clipsal surge protection device helps to protect your valued possessions from such harmful surges and spikes.



Step 3: Arc Fault Detection (AFD) Device – Helps to protect your home from arc faults

Old cables, loose wall sockets, poor cable connections, rodents/humidity in ceiling space can all result in damage to cables. Such damages result in electric arcs that carbonize the insulation/connection. If these arcs are not detected early then they can potentially result in electrical fires. Clipsal AFD device sits in your switchboard and continuously looks for early signs of such arc faults. As soon as it detects such signals, it helps to disconnect power in that circuit and helps to reduce chances of a potential house fire.



Contents

MCB/RCD Combinations – RCBO	11
1 device 2 functions	
Surge Protection Device – SPD	20
Helps to protect electrical appliances from voltage surges	
Arc Fault Detection Device – AFDD	22
Next level of protection for Australian homes	
Energy Management by Wiser™	26
Make smarter energy choices at home	
Miniature Circuit Breakers – MCB	28
Helps to protect electrical cables from overload and short circuit	
Residual Current Devices – RCD	33
Helps to protect people from potential electric shocks	
Main Switches	41
Helps to Isolate the whole board	
Plastic consumer switchboards and MAXBAR	44
Helps to bring everything together	
Accessories	59
For all other residential switchboard needs	
Technical Information	74



Naming conventions for devices

Catalog number format and legend

MX9	FN	B	CD	E
Range name MX9 – MAX9	Function R3 – RCBO 30 mA R1 – RCBO 10 mA RC – RCD A3 – AFDD 30 mA MC – MCB MS – Main switch SP – SPD C1 – Contactor 240V C2 – Contactor 24V TB – Terminal block	Module width	Current rating	Special function (if needed) F – 40ms tripping time S – Super immune R – Red toggle MCB 10 – 1 NO contactor 11 – 1NO+1NC contactor 20 – 2NO contactor 22 – 2NO+2NC contactor 40 – 4NO contactor

Example:

Description

Max9 RCBO 30mA 1 module 20A

Commercial reference

MX9R3120



MCB/RCD Combinations – RCBO

MCB/RCD Combinations – Slim RCBO

MAX9

Slim 1-Module MCB/RCD Combination C-Curve, Electronic – RCBO

Clipsal's slim DIN mounted, 30mA combination MCB/RCDs are available as single module devices to save valuable switchboard space.

Features and benefits:

- Top and bottom line and load compatible for ease of installation.
- Short circuit breaking capacity of 6kA.
- Rated at 240V, 30mA / 10mA, type A, C-Curve.
- One module width – ideal for retrofit installations where space is limited.
- Two-pole safety feature allows switching of both Active and Neutral contacts.
- Trip free locking device (lockable 'ON' or 'OFF' position).
- Compatible with Clipsal's 4LD Lock Dog.
- AS/NZS 61009 compliance.

Applications:

- Ideal for retrofit installations where pole space is a problem.
- Small width allows a greater number of RCBOs to be installed in one enclosure.

1P+N, 1-Module, 240V

A-type 30mA non delayed

Catalogue No.	Current Rating
MX9R3106	6A
MX9R3110	10A
MX9R3116	16A
MX9R3120	20A
MX9R3125	25A
MX9R3132	32A



MX9Rx1xx

1P+N, 1-Module, 240V

A-type 10mA non delayed

Catalogue No.	Current Rating
MX9R1106	6A
MX9R1110	10A
MX9R1116	16A
MX9R1120	20A
MX9R1125	25A
MX9R1132	32A

Connection

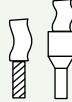
Type	Rating	Tightening torque	Copper cables	
Slim RCBO			Rigid	Flexible or ferrule
				
L and N upstream	6 to 32A	2 N.m.	1 to 16mm ²	1 to 10mm ²
L and N downstream	6 to 32A	2 N.m.	1 to 10mm ²	1 to 6mm ²

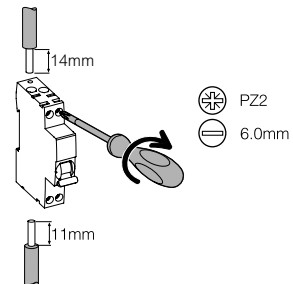

Weight

Residual current device	
Type	Slim RCBO
1P+N	136g

Technical Data

Main characteristics		
Voltage rating (Ue)	240V a.c.	
Insulation voltage (Ui)	440V a.c.	
Rated impulse withstand voltage (Uimp)	4kV	
Thermal tripping reference temperature	30°C	
Magnetic tripping	C-Curve	
Limitation class	Between 5 and 10 I _n	
Surge current withstand (8/20 μs) without tripping	3	
Rated nominal breaking capacity (I _{cn})	250A	
Phase/Earth rated residual breaking and making capacity (IΔm)	6000A	
Additional characteristics		
Degree of protection	Device only	IP20
	Device in modular enclosure	IP40
Endurance (O-C)	Electrical	10,000 cycles
	Mechanical	20,000 cycles
Operating temperature	-25°C to +70°C (Derating table refer to technical information)	
Storage temperature	-40°C to +85°C	
Tropicalisation	Severity B (relative humidity 95% at 55°C)	

Dimensions (mm)

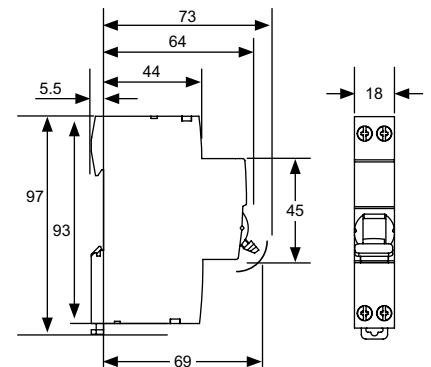

MCB/RCD Combinations – 2 module Type A-SI RCBO

MAX9

MCB/RCD Combinations – RCBO

Clipsal switchboard mounted combination MCBs and RCDs fall into two main categories - electro mechanical and electronic.

The electro mechanical devices derive their 'action energy' from actual leakage (residual) current.

They work on an electromagnetic principle. A toroidal transformer is used to detect the magnetic fields created by current flowing in the Active and Neutral wires of the protected circuit, which pass through the RCD.

Taking into account the magnitude and direction of these currents, under normal circuit conditions the vector sum of the currents (known as the residual current) is effectively zero and the magnetic fields cancel.

Should the condition occur where a current flows from an Active or Neutral wire to Earth, the residual current will not be zero and the magnetic field will establish a tripping signal to disconnect the protected circuit.

These devices are not voltage dependant.

Features and benefits:

- Separate RCD trip flag for easy trip diagnosis **(1)**
- Same base module as the MCBs. Uniformity in space requirements and installation.
- Top and bottom line and load compatible for ease of installation
- Green strip on the toggle that indicates opening of all the poles
- Top and bottom clip allowing dismounting with comb busbar in place
- Busbar compatible through an insulated slot

Applications

Super Immune - A-SI Type

- High dependency installation.

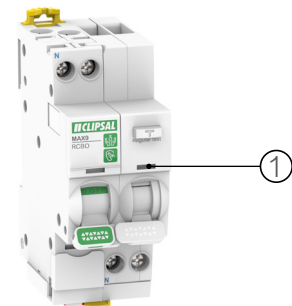

MX9R32xxS

MCB/RCD Combination C-Curve, Mechanical – RCBO

1P+N, 2-Module, 240V

SI-type, super immune, 30mA A-type, surge current protected to 3000 A 8/20µs

Catalogue No.	Current Rating
MX9R3210S	10A
MX9R3216S	16A
MX9R3220S	20A
MX9R3225S	25A
MX9R3232S	32A

Connection

Rating	Tightening torque	Copper cables	
		Rigid	Flexible or ferrule
10 to 32A	2 N.m	1 to 16mm ²	1 to 10mm ²

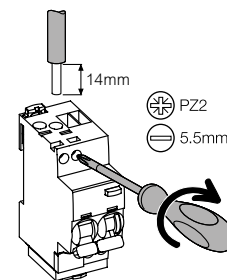

Weight

Residual current device	
Type	
1P+N	215g

Dimensions (mm)

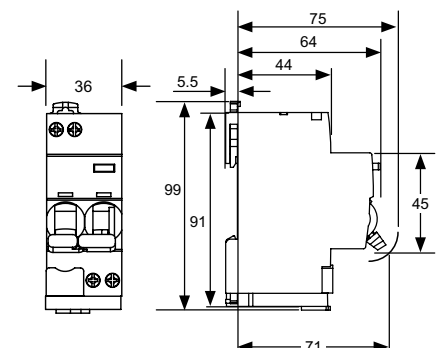

Technical Data

Main characteristics		
Earth leakage protection with instantaneous tripping	30mA Voltage independant	
Setting temperature for ratings	30°C	
Tripping curve	C-Curve The magnetic tripping devices act at between 5 and 10 I _n	
Rated breaking capacity (I _{cn})	6000A	
Rated residual breaking and making capacity (IΔm)	3000A	
Endurance (O-C)	Electrical	10,000 cycles
	Mechanical	20,000 cycles
Degree of protection	Device only	IP20
	Device in modular enclosure	IP40
Insulation voltage (U _i)	440V	
Rated impulse withstand voltage (U _{imp})	4kV	
Operating temperature	-25°C to +70°C (Derating table refer to technical information)	
Storage temperature	-40°C to +85°C	
8/20 µs impulse withstand without tripping	3kA	
Limitation class	3	
Tropicalisation	Severity B (relative humidity 95% at 55°C)	

MCB/RCD Combinations – 2 module Type A RCBO

MAX9

These 240V single-phase + Neutral electronic combination devices are 2 module wide and are compatible with top feeding MAXBAR.

Separate flag indication **(1)** for MCB or RCD tripping enables easy and speedy trip diagnosis.

Electronic type devices derive their 'action energy' from the mains supply. They typically utilise much simpler toroidal sensors, coupled to sensing amplifiers, filters, discrimination circuits and triac driven solenoids to operate the contacts.

The major advantages of electronic types lies in their simple construction, improving their chances in areas in adverse conditions where vibration and environmental conditions affect electrical products.

The added benefit of electronic types are that the filters prevent unwanted tripping. These devices are voltage dependent.

Applications

Standard – A Type

- General applications.
- Generators.
- Extreme environmental conditions.

1P+N, 2-Module, 240V

A Type, 30mA non-delayed

Catalogue No.	Current Rating
MX9R3210	10A
MX9R3216	16A
MX9R3220	20A
MX9R3225	25A
MX9R3232	32A
MX9R3240	40A

NOTE: This device is top feeding only.

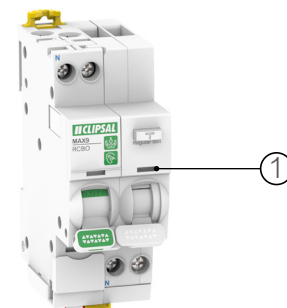

MX9R32xx

Connection

Rating	Tightening torque	Copper cables	
		Rigid	Flexible or ferrule
10 to 40A	2 N.m	1 to 16mm ²	1 to 10mm ²

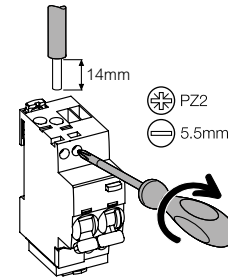

Weight

Residual current device	
Type	
1P+N	215g

Technical Data

Main characteristics		
Earth leakage protection with instantaneous tripping	30mA	Voltage dependant
Setting temperature for ratings		30°C
Tripping curve	C-Curve	The magnetic tripping devices act at between 5 and 10 I _n
Rated breaking capacity (I _{cn})		6000A
Rated residual breaking and making capacity (IΔm)		3000A
Endurance (O-C)	Electrical	10,000 cycles
	Mechanical	20,000 cycles
Degree of protection	Device only	IP20
	Device in modular enclosure	IP40
Insulation voltage (U _i)		440V
Rated impulse withstand voltage (U _{imp})		4 kV
Operating temperature		-25°C to +70°C (Derating table refer to technical information)
Storage temperature		-40°C to +85°C
8/20 μs impulse withstand without tripping		250A
Limitation class		3
Tropicalisation		Severity B (relative humidity 95% at 55°C)

Dimensions (mm)

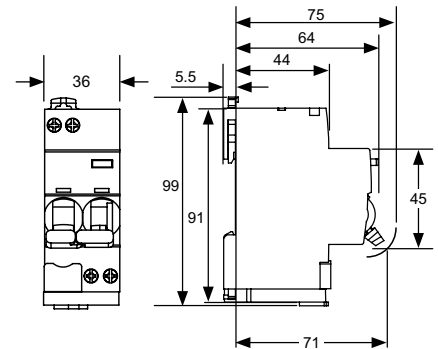

MCB/RCD Combinations – 3P+N RCBO

MAX9

3P+N, 5-Module RCBO C-Curve, Type A

AS/NZS 3000:2018 bring in a major change for residential applications. It states that additional protection by RCDs with a maximum rated residual current of 30mA shall be provided for all final sub-circuits. This clause applies irrespective of the circuit amperage or number of phases. This includes circuits for air conditioner, cooktops, hot water systems, pool pumps, etc. that were historically not protected by RCD. MAX9 3P+N RCBO helps to provide complete RCBO solution for 3 phase applications.

Features and benefits:

- Full installation flexibility with the option of having line connection either from top or bottom.
- Cover all your needs with complete range from 10A to 40A
- Type A earth leakage protection to help provide additional safety to end user
- Green strip on the toggle that indicates opening of all the poles.
- Easy diagnosis with visible red tripping flag to identify earth leakage tripping
- Clear marking of neutral on left side

Applications:

- Ideal for retrofit installations where pole space is a problem.
- Small width allows a greater number of MCB/RCDs to be installed in the one enclosure.

Catalogue No.	Current rating
MX9R3510	10A
MX9R3516	16A
MX9R3520	20A
MX9R3525	25A
MX9R3532	32A
MX9R3540	40A



MX9R35xx

Connection

Rating	Tightening torque	Copper cables	
		Rigid	Flexible or ferrule
10 to 40A	2 N.m	1 to 16mm ²	1 to 10mm ²

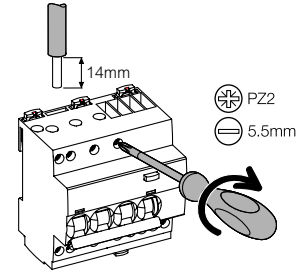

Weight

Residual current device	
Type	
3P+N	500g

Technical Data

Main characteristics		
Voltage rating (Ue)		415V
Insulation voltage (Ui)		440V
Rated impulse withstand voltage (Uimp)		4kV
Rated residual operating current (IΔn)		30mA
Thermal tripping reference temperature		30°C
Magnetic tripping	C-Curve	Between 5 and 10 In
Limitation class		3
Rated nominal breaking capacity (Icn)		6000A
Additional characteristics		
Degree of protection	Device only	IP20
	Device in modular enclosure	IP40
Endurance (O-C)	Electrical	10,000 cycles
	Mechanical	20,000 cycles
Operating temperature		-25°C to +70°C (Derating table refer to technical information)
Storage temperature		-40°C to +85°C
Tropicalisation		Severity B (relative humidity 95% at 55°C)

Dimensions (mm)

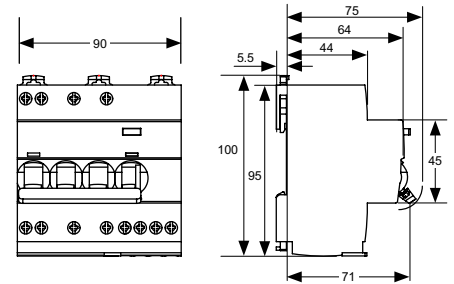



Surge Protection Device – SPD

Surge Protection Device – SPD

When lightning strikes, there are no second chances. The MAX9 range of surge protection devices won't let you down. Modern Australian homes have estimated \$15,000 worth of electronics unprotected against voltage surges. From fridge to washer/dryer, smart appliances have a lot of electronic components inside them. Surge protection strips only offer limited protection to the devices connected to them. Items that are not compatible with plug strips such as washers, dryers, refrigerators, stoves, and lighting can be protected against voltage surges with a Surge Protective Device. One device can help to protect whole house from voltage spikes.

Features and benefits:

- Maximum discharge capacity of 40kA (8/20µs)
- Includes single and three pole variants
- Uniform terminal heights and modular size enables neat and efficient installation
- Cartridge replacement is quick and easy
- Replacement cartridges available as spare part
- Possibility of Remote alarming.

Catalogue No.	Description
MX9SP140	Surge Arrestor, 1P, I _{max} 40kA
MX9SP340	Surge Arrestor, 3P, I _{max} 40kA
MX9SP40C	Replacement Cartridge 1P I _{max} 40kA



MX9SP140

MX9SP340





Arc Fault Detection Device – AFDD

Arc Fault Detection Device – AFDD

Arc Fault Detection Devices help to reduce the risk of electrical fire.

Broken wires, loose connections, crushed cables can all cause hidden arc faults in electrical circuits, which if left undetected, can erupt into flames in just seconds. AFDDs isolate the circuit the moment an arc fault is detected.

Arc faults are one of the main causes of electrical fires. Electrical fires due to arc faults are surprisingly common especially in older homes. Electrical fires cause considerable damage to property, injuries and deaths each year.

Some key facts are:

- Every year about 12,000 fires are reported from Australian homes.
- 40% of fires in homes are related to electrical fault and appliances.
- About 60 lives are lost each year due to fires in Australian homes.
- Millions are spent in repairing damage caused by fires in homes.

An arc fault is not always easy to see, since it can occur in hidden places such as damaged cables inside walls, a loose connection in a hidden junction box, or socket outlets.

How do arc faults occur?

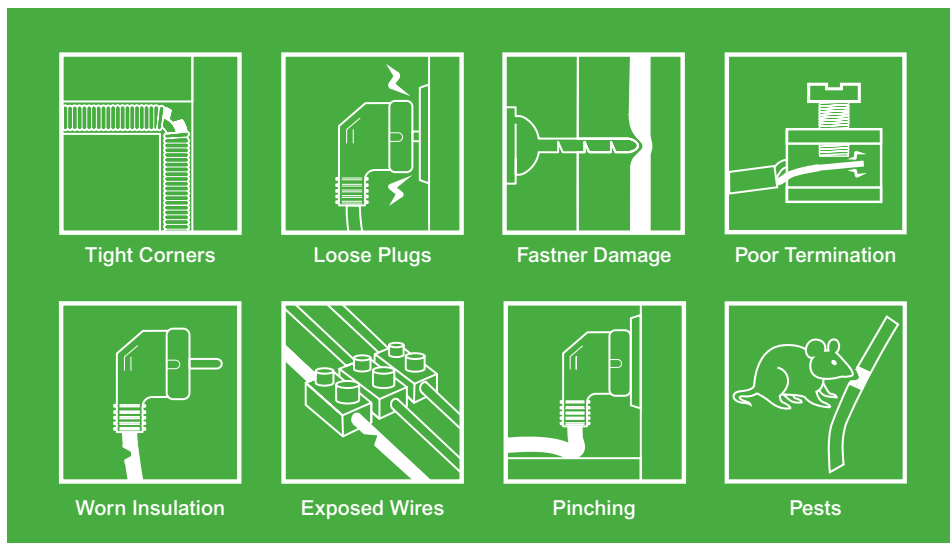

What is an Arc Fault Detection Device?

An AFDD is a detection device that automatically cuts the electricity supply when it detects an arc fault in a circuit. By immediately cutting off the electricity supply, AFDDs help to prevent arc faults from reaching temperatures where fires can break out.

AFDDs fit into electrical switchboards alongside other protective equipment. When an arc fault is detected, the device immediately isolates the circuit, preventing ignition of flammable materials.

An AFDD detects the appearance of electric arcs that are responsible for starting fires. They are extremely sensitive, designed to sense and respond only to potentially dangerous arcs.

Arc fault detection RCBO

MAX9

Features and benefits:

- Circuit protection against overload, short-circuit, earth leakage and Arc Fault.
- Two module width ideal for retrofit installations where space is limited.
- Top and bottom line and load compatible for ease of installation.
- Two pole safety feature allows switching of both active and neutral contacts.
- 6kA short circuit breaking capacity.
- Type A RCBO to sense both a.c. and pulsating d.c. currents.
- Fire hazard tripping indication via the front panel indicator.
- Device diagnosis via the test button.
- Green strip on the toggle that indicates opening of all the poles.
- Tripping cause diagnosis by LED blinking in front face.

Catalogue No.	Current rating
MX9A3206	6A
MX9A3210	10A
MX9A3216	16A
MX9A3220	20A
MX9A3225	25A

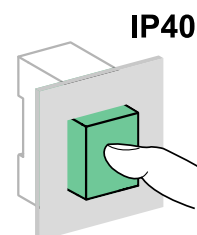
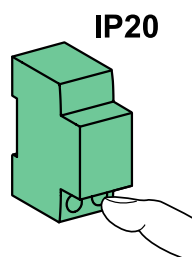
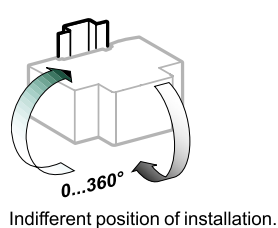
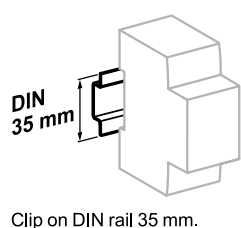
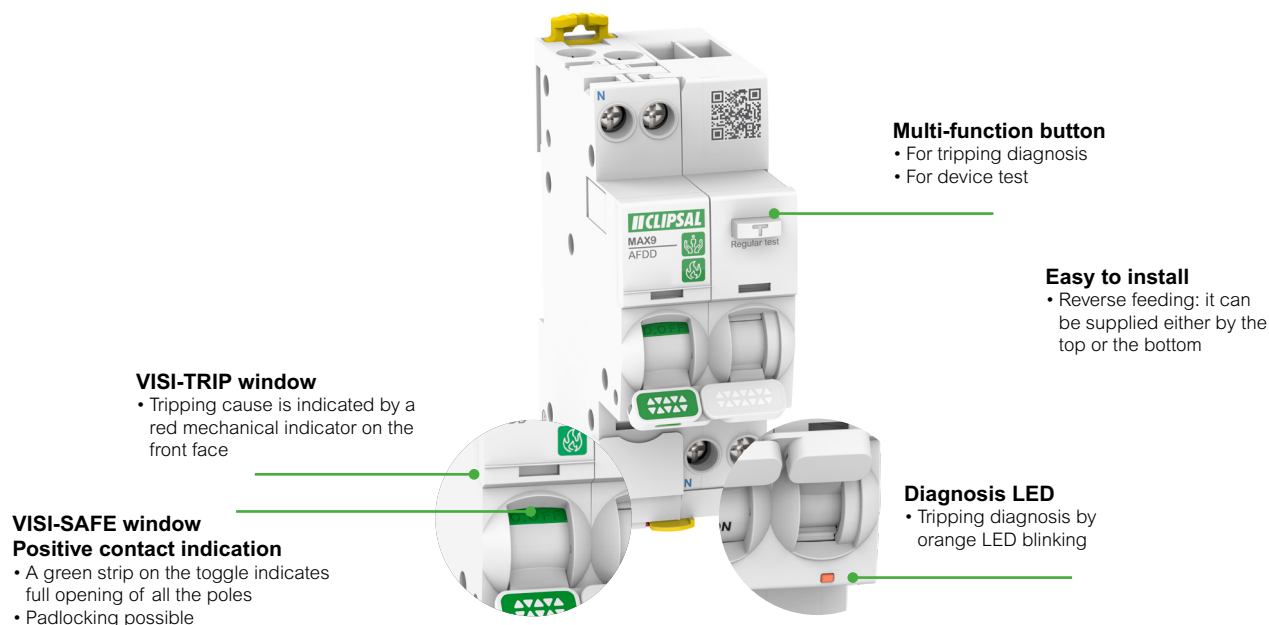

Connection

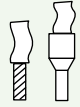
Tightening torque	Copper cables	
	Rigid	Flexible or ferrule
		
2 N.m	1 to 16mm ²	1 to 10mm ²

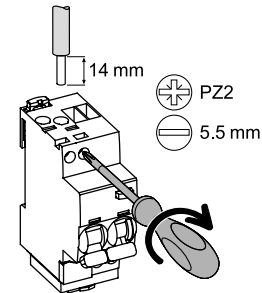

Weight

Residual current device	
Type	Weight
1P+N	237g

Technical Data

Main characteristics						
Tripping time/arc current value with $U_n = 230/240$ V AC (to IEC/EN 62606)	Current before arc (RMS)	2.5	5 A	10 A	16 A	25 A
	Max. operating time	1 s	0.5 s	0.25 s	0.15 s	0.14 s
Overvoltage tripping threshold (neutral conductor break)		275 V AC \pm 5 V				
Insulation voltage (U_i)		440V a.c.				
Degree of pollution		2				
Rated impulse withstand voltage (U_{imp})		4 kV				
Overvoltage category		III				
Thermal tripping	Reference temperature	30°C				
Magnetic tripping	Curve C	Between 5 and 10 I_n				
According to AS/NZS 61009.1						
Limitation class		3				
Rated breaking capacity (I_{cn})		6000A				
8/20 μ s impulse withstand current	A type	250 A				
Additional characteristics						
Earth leakage protection with instantaneous tripping		30 mA, type A				
Degree of protection		Device alone	IP20			
		Device in a modular enclosure	IP40			
Endurance (O-C) (IEC 60529)	Electrical	10,000 cycles				
	Mechanical	20,000 cycles				
Operating temperature		-25°C to +70°C (Derating table refer to technical information)				
Storage temperature		-40°C to +85°C				

Dimensions (mm)

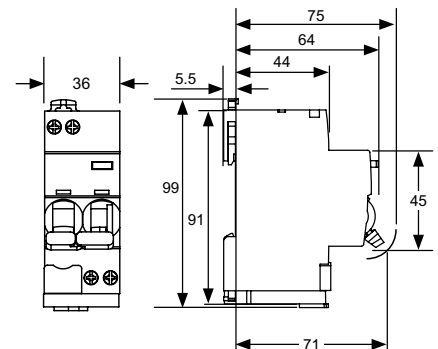

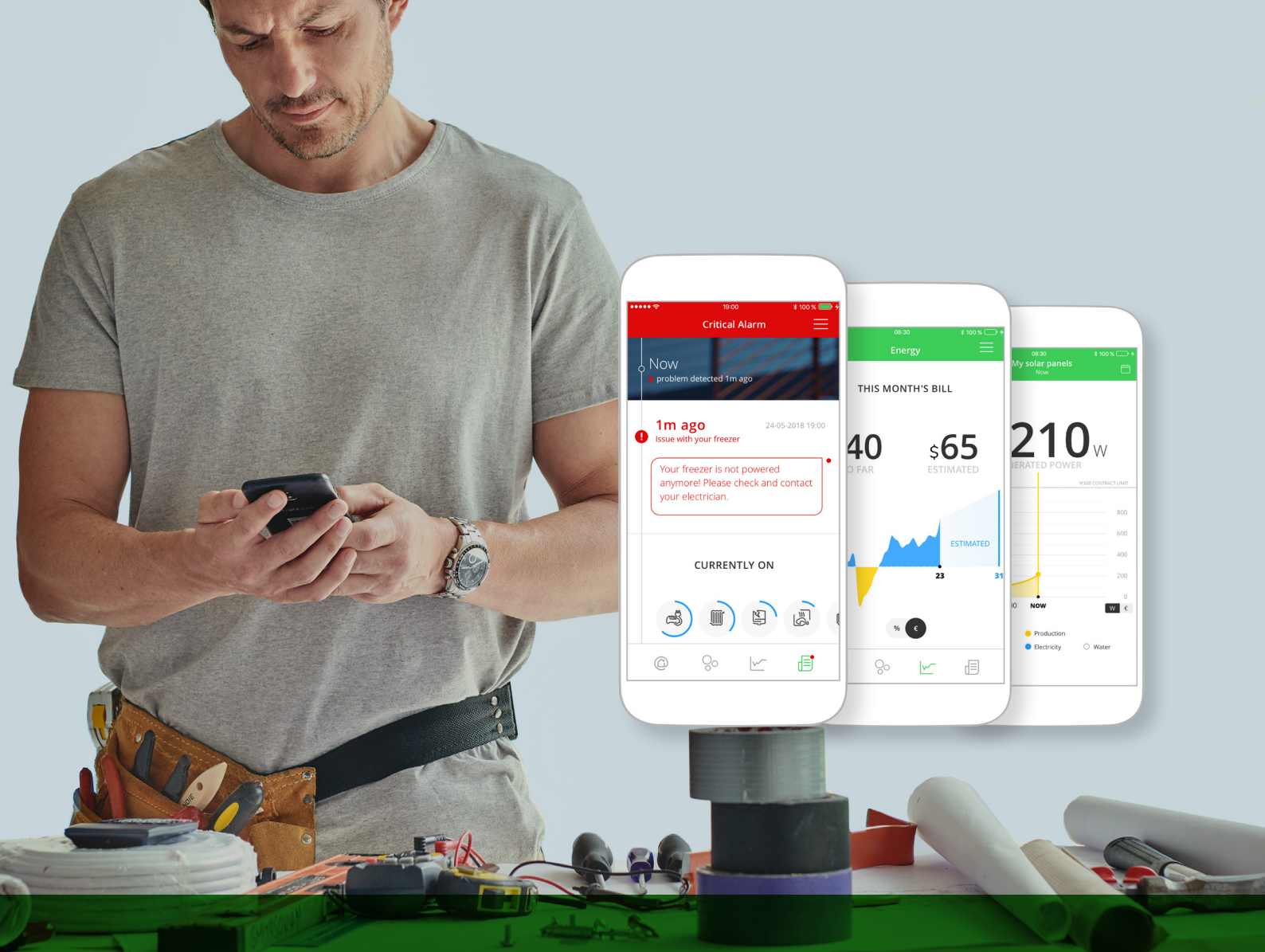

Energy Management by Wisenergy™

Energy Management by Wiser™

Energy takes up a significant chunk of every household budget. Tracking its usage is tricky, but essential to identifying inefficiencies and reducing energy spend. That's where Energy Management by Wiser™ comes in. As a smart, connected technology for homes it monitors your installation 24/7 to give you insight into its condition and your energy use. With Energy Management by Wiser™, you can manage your energy more efficiently, save on bills, and gain visibility of your installation status, even if you're not an energy expert.

Features and benefits:

- Easy app interface for home owners.
- All energy consumption and production data at your finger tips.
- No nasty surprises with electricity bills.
- Get better return on your solar investment.
- No cable connection needed between powertags and gateway.
- Simple commissioning for electrician with bluetooth enabled. mobile phone or tablet.
- Convert any residential switchboard into a smart communicating board.

Catalogue No.	Description
EER72600	Wiser IP communication module
4CBEM1	POWERTAG WISER M63 1PW
4CBEM3	POWERTAG WISER M63 3P
4RCBEM2B	POWERTAG WISER P63 1PN BOTTOM RCBO
4RCBEM2T	POWERTAG WISER P63 1PN TOP RCBO
4RCBEM2	POWERTAG WISER F63 1PN
4RCBEM4	POWERTAG WISER F63 3PN



Miniature Circuit Breakers

The Range

Clipsal offer an industry leading range of miniature circuit breakers (MCBs), which are ideal for retrofit installations or switchboards that are limited for space.

Clipsal MCBs are suitable for horizontal or vertical 35mm DIN rail mounting, with the option of a two-position clip. All Clipsal MCBs are moulded from heavy-duty material and are finger-proof, providing additional protection from live terminal contact.

Clipsal MAX9 MCBs include two types of operation:

- Thermal, for normal overload.
- Magnetic, for short circuit situation.

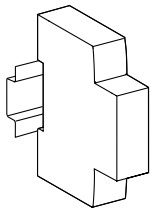

35mm DIN rail installations

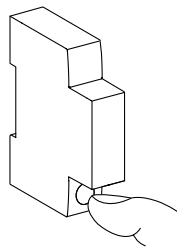
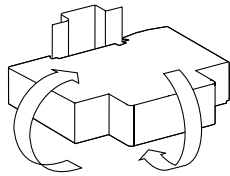

IP20 protection device only

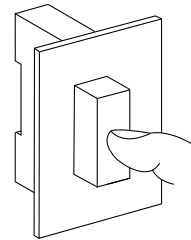

IP40 protection device in modular enclosure

Miniature Circuit Breakers

Thermal operation

Occurs when the bi-metal strip **(1)**, is heated by the overload current and deflected. This trips the tripping lever which, with its spring action **(2)**, causes the contacts **(3)** to open.

Magnetic tripping

Is achieved by utilising the solenoid **(4)**, which causes the armature **(5)** in conjunction with the mechanical action of the spring **(2)** to open the MCB's contacts.

Note: The splitter plates **(6)** break up the ionised gas as the switch mechanism opens, extinguishing the arc.

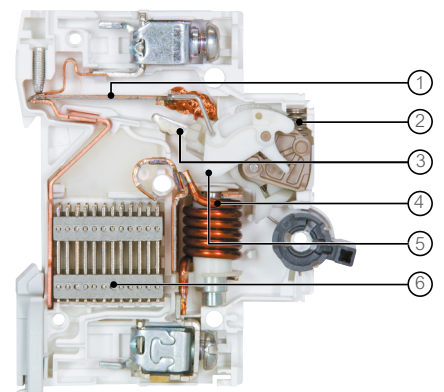

Miniature Circuit Breakers

MAX9

Features and benefits:

- Unique new white finish for a fresh modern look.
- Standard characteristic is C-Curve suits most applications.
- Complete solution with 1, 2 & 3 pole versions.
- Option of 1P,2P & 3P 63A MCB with red toggle where MCB is used as main incomer.
- Base module = 18mm wide. Compact standardised and consistent module dimensions.
- Lift-up terminals. 'No hot spot' terminations and all cable strands are locked in.
- Combination head screws, choice of screwdrivers.
- MCB mechanism is free tripping and If the switch is held in the ON position, the MCB will still operate.
- Clipsal MCBs allow line or load cables to be connected at either top or bottom for greater installation flexibility.

Connection (1):

- Cable automatically guided to the correct position: terminals with guard.
- Insulated terminals IP20.
- Enhanced cable tear-off strength: serrated terminals.
- Fast closure.
- Bottom/Top side by tunnel terminals.

Positive contact indication (2):

- The presence of the green strip helps to ensure physical opening of the contacts and allows operations to be performed on the downstream circuit in complete peace of mind.

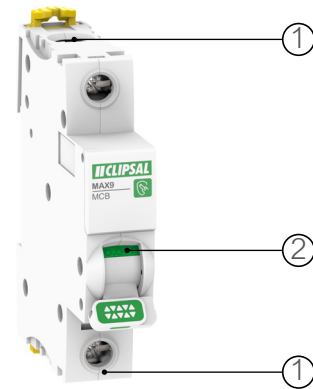

6kA C-Curve – MCB

The 6kA breaking capacity of these MCBs makes them ideal for residential applications that need MAX performance. This range has C-Curve characteristics, to suit most applications.

1-Pole, 1-Module, 240V

Catalogue No.	Current rating
MX9MC102	2A
MX9MC104	4A
MX9MC106	6A
MX9MC110	10A
MX9MC116	16A
MX9MC120	20A
MX9MC125	25A
MX9MC132	32A
MX9MC140	40A
MX9MC150	50A
MX9MC163	63A
MX9MC163R	63A (Red toggle)



MX9MC1xx



MX9MC163R

2-Pole, 2-Module, 415V

Catalogue No.	Current rating
MX9MC206	6A
MX9MC210	10A
MX9MC216	16A
MX9MC220	20A
MX9MC225	25A
MX9MC232	32A
MX9MC240	40A
MX9MC250	50A
MX9MC263	63A
MX9MC263R	63A (Red toggle)



MX9MC2xx



MX9MC263R

3-Pole, 3-Module, 415V

Catalogue No.	Current rating
MX9MC306	6A
MX9MC310	10A
MX9MC316	16A
MX9MC320	20A
MX9MC325	25A
MX9MC332	32A
MX9MC340	40A
MX9MC350	50A
MX9MC363	63A
MX9MC363R	63A (Red toggle)



MX9MC3xx





MX9MC363R

Miniature Circuit Breakers

MAX9

Connection

Rating	Tightening torque	Copper cables	
		Rigid	Flexible or ferrule
			
1 to 25A	2 N.m	1 to 25mm ²	1 to 16mm ²
32 to 63A	3.5 N.m	1 to 35mm ²	1 to 25mm ²

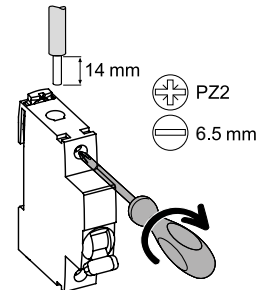

Weight

Circuit-breaker	
Type	
1P	125g
2P	250g
3P	375g

Dimensions (mm)

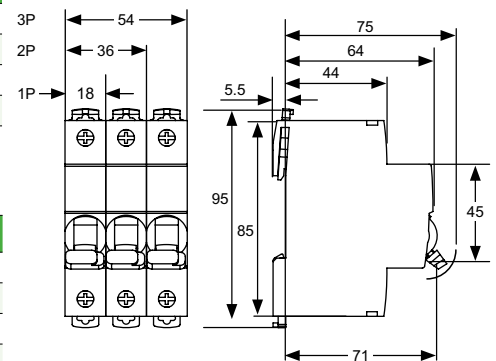

Technical Data

Main characteristics		
Insulation voltage (Ui)	500V a.c.	
Rated voltage (Ue)	240/415V a.c.	
Operating frequency	50/60Hz	
Thermal tripping	C-Curve	5 to 10 In
According to AS/NZS 60898.1		
Limitation class	3	
Rated breaking capacity (Icn)	6000A	
Service breaking capacity (Ics)	100% Icn	
Rated making and breaking capacity of an individual pole (Icn1)	Icn1=Icn	
Additional characteristics		
Degree of protection (IEC 60529)	Device only	IP20
	Device in modular enclosure	IP40
Endurance (O-C)	Electrical	10,000 cycles
	Mechanical	20,000 cycles
Operating temperature	-25°C to 70°C (Derating table refer to technical information)	
Storage temperature	-40°C to 85°C	
Tropicalisation (IEC 60068-1)	Severity B (relative humidity 95% to 55°C)	

Residual Current Devices

Residual Current Devices

MAX9

RCD – Residual Current Devices

Although Australia has one of the safest electrical systems in the world, accidents can still happen. A poorly maintained appliance, a person who innocently pushes something into a power socket or cuts through an electrical wire, a frayed cord, wet hands or carelessness with power tools are all situations that can lead to serious consequences.

Benefits of residual current devices (RCDs) are well documented and latest version of wiring rules (AS/NZS 3000:2018) makes it mandatory to have RCD protection for all final sub-circuits in residential applications.

Amendment 2 of AS/NZS 3000:2018 makes it mandatory to have type A RCD (no type AC RCD) from May 2023 for additional safety. All RCDs under MAX9 range are future ready and already type A.

How an RCD works

The RCD works by constantly monitoring and comparing the current flow in both the Active and Neutral cables of an electrical installation.

During normal operation, these Active and Neutral currents are in balance. However, should any current flow to Earth, an imbalance is created in these circuits. If this imbalance is sufficient, the RCD will cut the electrical supply.

Apart from helping to protect people, RCD will also cut off power to expensive electrical equipment in the event of an electrical fault to Earth. This helps to protect appliances against costly damage and the installation against fire, resulting from faults of this nature.

Switchboard Mounted RCDs

These RCDs incorporate the same housing and installation features as the MCBs. With a range that includes pulse current sensitive and super immune devices, there's a unit for every application.

Features and benefits:

- Covers all potential residential needs – 2 pole and 4 pole variants available.
- Line and load can be top or bottom connected, ideal when cabling space is restricted or limited.
- Lift-up terminals. helps to reduce chances of 'hot spot' in terminations with all cable strands are locked in
- Compatible with MAX9 18 mm pin type busbar for connections to multiple MCBs..

Connection (1):

- Upstream/downstream by tunnel terminal.
- DIN locking clip.

Positive contact indication (2):

- Green strip on the toggle that indicates opening of all the poles and allows operations to be performed on the downstream circuit with complete peace of mind.

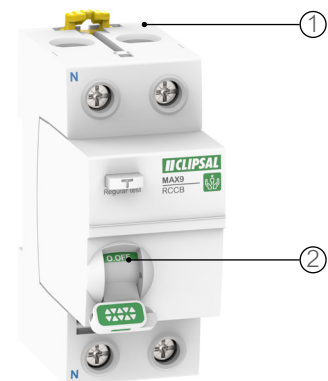

Clipsal MAX9 range also provides SI type RCD.

Clipsal A-SI-Type (super immune) RCDs

The SI range of RCDs helps to reduce nuisance tripping caused by Earth leakage currents below 30mA threshold.

Applications

A-SI-Type

- High dependency installations.
- Computers.
- Fluorescent lighting with electronic ballasts.

Fault current

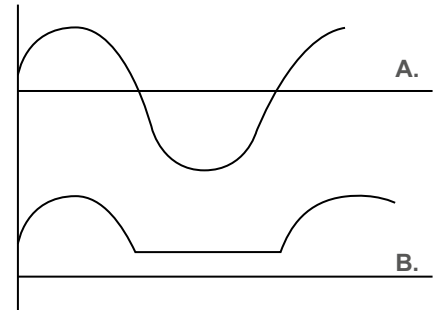

A. 30mA pure sine wave a.c.

Non d.c. sensitive breakers will trip and d.c. sensitive breakers will trip.

B. The test current is half wave pulsating d.c.

Non d.c. sensitive breakers may not trip but d.c. sensitive breakers will trip.

High frequency oscillations

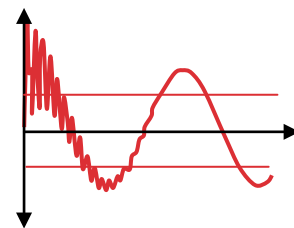

Slow and damped oscillations

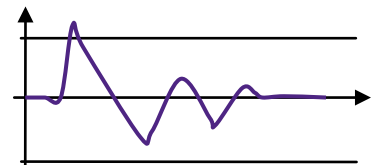



Residual Current Devices

MAX9

Interference Immunity – AC, A and SI-Types – RCDs

Clipsal provides various equipment technologies capable of overcoming the consequences of interference of all kinds.

Operating conditions		Examples	Types		
			AC 	A 	A-SI 
Characteristics					
With no special characteristics		General purpose power sockets Incandescent lighting Household appliances: microwave oven, dishwasher, clothes dryer Electric heating, water heater	Yes	Yes	Yes
Including a rectifier	Single-phase	Household appliances: induction cooking appliances, washing machines (variable speed) Single-phase variable speed drives	-	Yes	Yes
	Three-phase	Three-phase variable speed industrial drives Three-phase uninterruptible power supplies	-	-	-
Generating high frequency interference (current peaks, harmonics)		Fluorescent lighting powered by extra low voltage transformer, by electronic ballast Variable luminosity lighting Powerful IT equipment Single-phase variable speed industrial drives Air conditioning Telecommunications equipment Capacitor banks	-	-	Yes
Including an anti-harmonic filter in the power supply		Microcomputer systems Computer peripherals (printers, scanners, etc.)	-	-	Yes
Electrical Environment					
Vicinity of equipment generating transient overvoltages		High-powered switching devices Reactive energy compensation banks	-	-	Yes
Circuits powered by an uninterruptible power supply		Backed-up networks	-	-	Yes
"Isolated neutral" (IT) Earthing system		-	-	-	Yes
Major risk of lightning strikes		Buildings protected by a lightning protection system Mountainous or humid regions Regions with high keraunic level	-	-	Yes
Atmosphere					
Ambient temperature which could be less than -5°C		-	-	Yes	Yes
Presence of corrosive agents (AF2 to AF4) or dust		Indoor swimming pools Harbours, marinas, camping grounds Water treatment Chemical industries, heavy industries, paper mills Mines and cellars, road tunnels Markets, stock raising, food processing industries	-	-	Yes

A-Type – RCD

Comes in 2 and 4 pole, 40 to 63 amps to suit most residential applications.

Applications

Standard Type – A-Type

- General applications.

2-Pole, 2-Module, 240V

A-type, 30mA, non-delayed, surge current protected to 250A 8/20µS

Catalogue No.	Current rating
MX9RC240	40A
MX9RC263	63A



MX9RC2xx

4-Pole, 4-Module, 415V

A-type, 30mA, non-delayed, surge current protected to 250A 8/20µS

Catalogue No.	Current rating
MX9RC440	40A
MX9RC463	63A





MX9RC4xx

Residual Current Devices

MAX9

Connection

Rating	Tightening torque	Copper cables	
		Rigid	Flexible or ferrule
			
40 to 63A	3.5 N.m	1 to 35mm ²	1 to 25mm ²

Weight

Residual current device	
Type	
2P	210g
4P	370g

Technical Data

Main characteristics		
Insulation voltage (Ui)		440V
Degree of pollution		2
Rated impulse withstand voltage (Uimp)		4kV
According to AS/NZS 61008.1		
Making and breaking capacity (Im/IΔm)		10In or 500A, whichever is the bigger
Impulse current withstand (8/20 μs without tripping)	AC type	250A
Rated conditional short circuit current (Inc/IΔc)		6000A with MAX9 MCB
Additional characteristics		
Degree of protection	Device alone	IP20
	Device in modular enclosure	IP40
Endurance (O-C)	Electrical	4000 cycles
	Mechanical	10,000 cycles
Operating temperature		-25°C to +70°C (Derating table refer to technical information)
Storage temperature		-40°C to 85°C

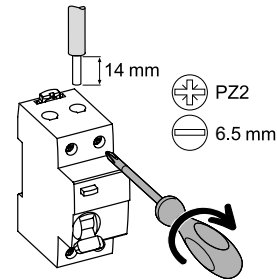

Dimensions (mm)

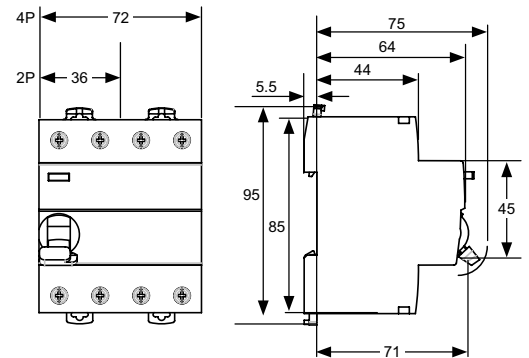

A-SI Type RCD

2-Pole, 2-Module, 240V

A-SI type, 30mA, super immune

Catalogue No.	Current rating
MX9RC263S	63A



MX9RC263S

4-Pole, 4-Module, 415V

A-SI type, 30mA, super immune

Catalogue No.	Current rating
MX9RC463S	63A





MX9RC463S

Residual Current Devices

MAX9

Connection

Rating	Tightening torque	Copper cables	
		Rigid	Flexible or ferrule
			
63A	3.5 N.m	1 to 35mm ²	1 to 25mm ²

Weight

Circuit-breaker	
Type	
2P	210g
4P	370g

Technical Data

Main characteristics		
Insulation voltage (U _i)		440V
Degree of pollution		2
Rated impulse withstand voltage (U _{imp})		4kV
According to AS/NZS 61008-1		
Making and breaking capacity (I _m /I _{Δm})		10 I _n
Impulse current withstand (8/20 μs without tripping)	(si) type	3kA
Rated conditional short circuit current (I _{nc} /I _{Δc})		6000A with MAX9 MCB
Additional characteristics		
Degree of protection	Device alone	IP20
	Device in modular enclosure	IP40
Endurance (O-C)	Electrical	4000 cycles
	Mechanical	10,000 cycles
Operating temperature		-25°C to +70°C (Derating table refer to technical information)
Storage temperature		-40°C to 85°C

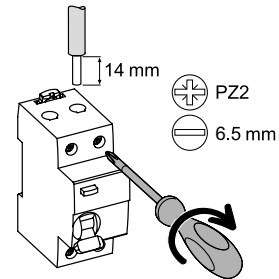

Dimensions (mm)

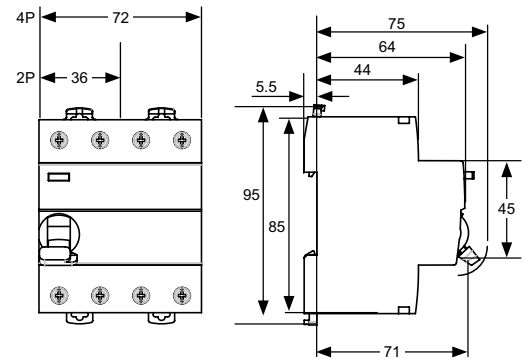



Main Switches

Main Switches

MAX9

Main switches

Clipsal offers an optimised range of high quality mains switches for residential applications. They are available in 100A, with 1, 2 and 3-pole versions, so you'll be able to find the ideal main switch for your next project.

All Clipsal Main Switches incorporate high quality internal mechanisms and come with a highly visible ON/OFF toggle, which allows for quick location when isolation of power is required in an emergency.

Isolating Switches, Residential

Isolating switches are available in 1, 2 and 3 pole models.

Features and benefits:

- Cable automatically guided to the correct position: terminals with guard.
- Insulated terminals – IP20.
- Manual control on front face by O-I lever.
- Green strip on toggle indicates full opening of the poles
- Ease of selection with optimised offer
- Ability to withstand harsher environment with Pollution degree 3
- Operating temperature up to 70 Deg C

Catalogue No.	Description
MX9MS1100	1P, 100A
MX9MS2100	2P, 100A
MX9MS3100	3P, 100A

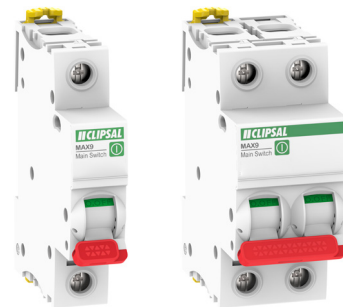

MX9MS1100

MX9MS2100



MX9MS3100

Connection

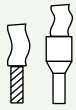
Type	Rating	Tightening torque	Copper cables	
			Rigid	Flexible or ferrule
				
Switch	100A	3.5 N.m	6 to 50mm ²	6 to 35mm ²

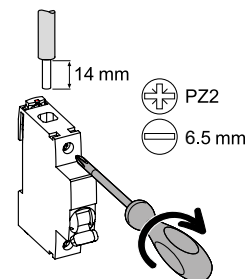

Weight

Isolator	
Type	
1P	85g
2P	170g
3P	255g

Technical Data

Main characteristics		
Insulation voltage (Ui)	500V a.c.	
Pollution degree	3	
Power circuit		
Rated impulse withstand voltage (Uimp)	6kV	
Operating category	AC-22A	
Permissible rated short-time withstand current (Icw)	1500A / 1s	
Conditional rated short circuit current (Inc)	6kA with MAX9 MCB	
Rated short circuit closing current (Icm)	5kA	
Additional characteristics		
Degree of protection	Device only	IP20
	Device in modular enclosure	IP40
Endurance (O-C)	Mechanical	20,000 cycles
	Electrical	10,000 cycles
Operation temperature	-25°C to +70°C	
Storage temperature	-40°C to +85°C	
Tropicalisation	Severity B (relative humidity 95% at 55°C)	

Dimensions (mm)

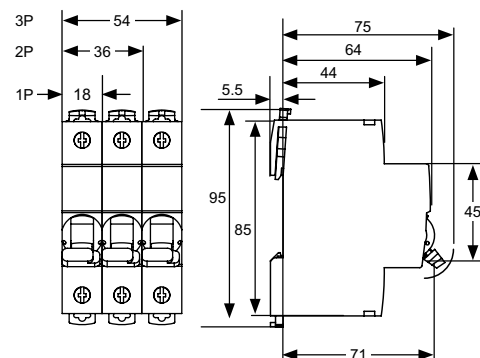



Plastic consumer switchboards and MAXBAR

Plastic consumer switchboards

The requirements of electrical contractors have always been of prime importance to Clipsal. This is more than evident in MAX9 range of plastic enclosures. Widest range of premium plastic enclosures are available in flush and surface-mounted versions, 6 to 60 module wide options and different aesthetics to suit varying customer preferences. These enclosures offer generous wiring room and are made of durable plastic material.

Catalog number format and legend

MX9	FN	B	CD	E
Range name MX9 – MAX9	Function E1 – Enclosure type 1 E2 – Enclosure type 2 E3 – Enclosure type 3 EW – Enclosure weatherproof	Number of rows 1 2 3 4	Number of 18 mm modules per row	Mounting method S – Surface mount enclosure F – Flush mount enclosure

Example:

Description

MAX9 Enclosure type 2 with 2 rows and 15 modules per row surface mount

Commercial reference

MX9E2215S

Enclosure characteristics



Type of Enclosure	Type 1	Type 2	Type 3	Weatherproof
No of Modules	06 – 36 ways	15 – 60 ways	36 – 54 ways	24 – 36 ways
Mounting type	Surface and Flush	Surface and Flush	Surface and Flush	Surface
Color	RAL 9003 (White)	RAL 9003 (White)	RAL 9003 (White)	RAL 9003 (White)
IP	IP 30	IP 40	IP 40	IP 56
Material	Plastic Metal for Flush back box	Plastic Metal Spacer for Flush back box	Plastic	Plastic
Door	Single Door	Double doors	Single Door	Single Door
Accessories	Pole filler Green Circuit Labels	Pole filler Green Circuit Labels	Pole filler Green Circuit Labels	Pole filler Green Circuit Labels

Plastic consumer switchboards

MAX9 Type 1 Enclosure

Features and benefits:

- Peace of mind with Type tested system as per AS/NZS 61439-3
- Extra wiring space with 135 mm Space between the DIN rails and sufficient space under the DIN rail
- Flush enclosure with Metal Back box helps to provide mechanical protection to cables
- Flexibility in installation:
 - Position of Door on left or right for multirow row enclosures brings adaptability in tight corners
 - Reversible back box for multirow enclosures allows flexibility to choose the position on Earth/Neutral bar to your style
 - Multiple cable entry/exit knock-outs
- Removable DIN rail Brings to help organise the cables in position before mounting the devices
- Ample Earth and Neutral terminals to suit your typical configurations and comply to MEN type system

Surface Mount Enclosures

Catalogue No.	Description	No of Rows	Total No of Modules
MX9E1106S	1 row, 6 ways, Surface mounted	1	6
MX9E1111S	1 row, 11 ways, Surface mounted	1	11
MX9E1117S	1 row, 17 ways, Surface mounted	1	17
MX9E1212S	2 rows, 24 ways, Surface mounted	2	24
MX9E1312S	3 rows, 36 ways, Surface mounted	3	36



MX9E1117S

MX9E1212S

Flush Mount Enclosures

Catalogue No.	Description	No of Rows	Total No of Modules
MX9E1111F	1 row, 11 ways, Flush mounted	1	11
MX9E1117F	1 row, 17 ways, Flush mounted	1	17



MX9E1117F

Technical Data

Main characteristics	Type 1
Rated Current	100A
Rated voltage	240/ 440 V
Rated Insulation voltage	500 V
IP Rating - Door Closed	IP3X
IK Rating	IK07
Color	RAL9003 White
Space between DIN rails	135mm
Isolation Class	2
Pole filler supplied	1 strip (8 modules) for 1,2 row 2 strips (16 modules) for 3 row
Green label supplied	1 sheet for 1row 2 sheets for 3 row
Compliance to Distribution boards standard	AS NZS 61439-3
Supports the Compliance to Wiring regulations	AS NZS 3000

Surface Mount Enclosures

Catalogue No.	Encl. Height (H) mm	Encl. Width (W) mm	Encl. Depth (D) mm	No. of tunnels x Max cable size				Knockout dim. and location	
				Earth Bar		Neutral Bar		Back	
				16 mm ²	35 mm ²	16 mm ²	35 mm ²	Single KO Ø 118 x 51mm	Triple KO Ø 40mm x Ø 32mm x Ø 25mm
MX9E1106S	210	142	101	-	3	1	7	1	-
MX9E1111S	210	231	113	11	1	10	2	2	2
MX9E1117S	210	341	113	11	1	17	3	2	2

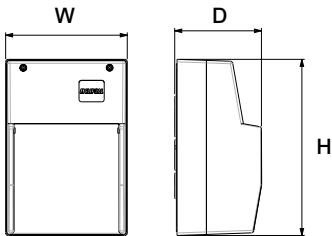

Catalogue No.	Encl. Height (H) mm	Encl. Width (W) mm	Encl. Depth (D) mm	No. of tunnels x Max cable size				Knockout dim. and location				
				Earth Bar		Neutral Bar		Back	Top/Bottom			
				16 mm ²	35 mm ²	16 mm ²	35 mm ²	Double KO Ø 40mm x Ø 32mm x Ø 25mm	Single KO Ø 40mm	Triple KO Ø 40mm x Ø 32mm x Ø 25mm	Single KO Ø 32mm	Single KO Ø 25mm
MX9E1212S	424	345	106	24	1	25	2	8	8	8	8	8
MX9E1312S	560	345	106	39	2	25	2	12	-	-	-	-

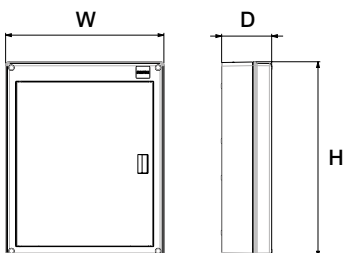

Plastic consumer switchboards

Flush Mount Enclosures

Catalogue No.	Encl. Height (H) mm	Encl. Width (W) mm	Encl. Depth (D) mm	Back Box Height (a)	Back Box Width (c)	Back Box Depth (b)	No. of tunnels x Max cable size		Knockout dim. and location								
							Earth Bar		Neutral Bar		Back	Left/Right	Top/Bottom				
							16 mm ²	35 mm ²	16 mm ²	35 mm ²			Single KO Ø 20	Single KO Ø 40mm	Single KO Ø 40mm	Single KO Ø 32mm	Single KO Ø 25mm
MX9E1111F	280	310	96	240	270	76	11	1	10	2	2	2	2	-	6	6	
MX9E1117F	280	418	96	240	378	76	11	1	17	3	4	2	6	1	8	8	

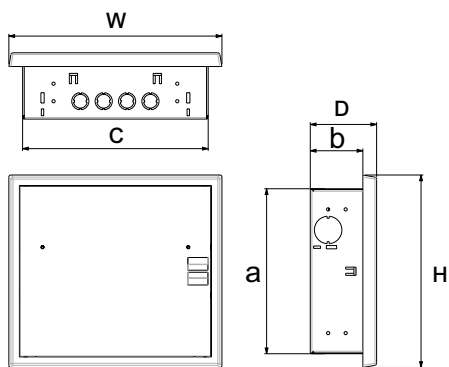

Note: MX9XT3 can be used as extra neutrals lugs for outgoing ways where required

MAX9 type 2 enclosure

Features and benefits:

- Peace of mind with type tested system as per AS/NZS 61439-3.
- Extra wiring space with 135 mm space between the DIN rails and more space on the sides of DIN rail to run your cables
- Metal back plate option for flush mount enclosures helps to provide mechanical protection to cables
- Flexibility in installation:
 - Reversible back box for multirow enclosures allows flexibility to choose the position on Earth/Neutral bar to your style.
 - Multiple cable entry/exit knock-outs
- Wide range of offer with up to 60 modules to choose from brings flexibility
- Ample Earth and Neutral terminals to suit your typical configurations and comply to MEN type system.

Surface Mount Enclosures

Catalogue No.	Description	No of Rows	No of Modules
MX9E2115S	1 row, 15 ways, Surface mounted	1	15
MX9E2215S	2 rows, 30 ways, Surface mounted	2	30
MX9E2315S	3 rows, 45 ways, Surface mounted	3	45
MX9E2415S	4 rows, 60 ways, Surface mounted	4	60



MX9E2215S

Flush Mount Enclosures

Catalogue No.	Description	No of Rows	No of Modules
MX9E2115F	1 row, 15 ways, Flush mounted	1	15
MX9E2215F	2 rows, 30 ways, Flush mounted	2	30
MX9E2315F	3 rows, 45 ways, Flush mounted	3	45
MX9E2415F	4 rows, 60 ways, Flush mounted	4	60



MX9E2215F

Plastic consumer switchboards

Technical Data

Main characteristics	Type 2
Rated Current	100A
Rated voltage	240/ 440 V
Rated Insulation voltage	500 V
IP Rating - Door Closed	IP4X
IK Rating	IK07
Color	RAL9003 White
Space between DIN rails	135mm
Isolation Class	2
Pole filler supplied	1 strip (8 modules) for 1 row 2 strips (16 modules) for 2,3 row 3 strips (24 modules) for 4 row
Green label supplied	1 sheet for 1row 2 sheet for 2,3,4 row
Compliance to Distribution boards standard	AS NZS 61439-3
Supports the Compliance to Wiring regulations	AS NZS 3000

Surface Mount Enclosures

Catalogue No.	Encl. Height (H) mm	Encl. Width (W) mm	Encl. Depth (D) mm	No. of tunnels x Max cable size				Knockout dim. and location			
				Earth Bar		Neutral Bar		Back		Top	Bottom
				16 mm ²	35 mm ²	16 mm ²	35 mm ²	Triple KO Ø32mm x Ø25mm x Ø20mm	Double KO Ø25mm x Ø20mm	Triple KO Ø32mm x Ø25mm x Ø20mm	Triple KO Ø32mm x Ø25mm x Ø20mm
MX9E2115S	258	376	120	12	2	12	1	-	-	5	4
MX9E2215S	392	376	120	29	4	24	2	5	3	5	4
MX9E2315S	666	376	120	41	7	35	4	8	-	4	4
MX9E2415S	800	376	120	58	8	39	2	8	-	4	4

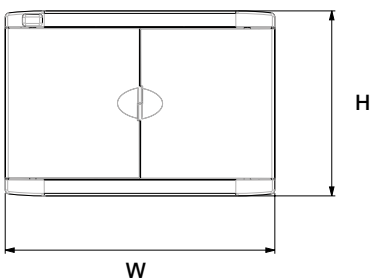
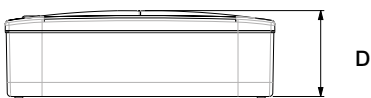

Flush Mount Enclosures

Catalogue No.	Encl. Height (H) mm	Encl. Width (W) mm	Encl. Depth (D) mm	Back Box Height (c)	Back Box Width (a)	Back Box Depth (b)	No. of tunnels x Max cable size				Knockout dim. and location		
							Earth Bar		Neutral Bar		Left/Right	Top	Bottom
							16 mm ²	35 mm ²	16 mm ²	35 mm ²	Single KO Ø 25mm	Single KO Ø 30mm x 25mm	Single KO Ø 30mm x 25mm
MX9E1111F	258	376	104	222	334	67	12	2	12	1	-	10	10
MX9E1117F	392	376	104	356	334	67	29	4	24	2	-	10	10
MX9E1111F	666	376	104	631	334	65	41	7	35	4	4	10	10
MX9E1117F	800	376	104	765	334	65	58	8	39	2	6	10	10

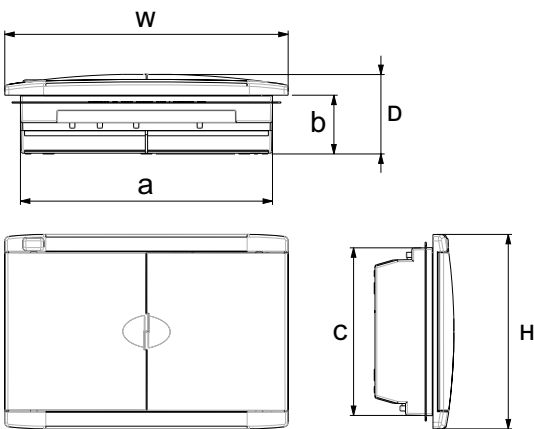

Note: MX9XT3 can be used as extra neutrals lugs for outgoing ways where required

Metal Back Plate for Type 2 Flush Mount Enclosures

To suit the wiring regulation AS/NZS 3000 with WSX3 protection (Section H 5.4)

Catalogue No.	Description	Suits to Enclosure Catalogue no
E2115FBP	Metal Back plate 1 row Type 2 enclosure	MX9E2115F
E2215FBP	Metal Back plate 2 row Type 2 enclosure	MX9E2215F
E2315FBP	Metal Back plate 3 row Type 2 enclosure	MX9E2315F
E2415FBP	Metal Back plate 4 row Type 2 enclosure	MX9E2415F



Catalogue No.	Height (A) mm	Width (B) mm	Thickness (C) mm
E2115FBP	290	330	2
E2215FBP	400	330	2
E2315FBP	650	330	2
E2415FBP	760	330	2

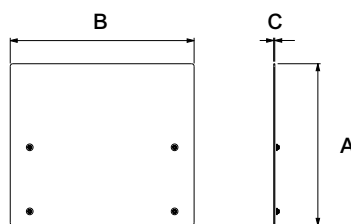

Plastic consumer switchboards

MAX9 Type 3 Enclosure

Features and benefits:

- Peace of mind with Type tested system as per AS/NZS 61439-3.
- Ease of installation with MAX wiring space with 150 mm space between the DIN rails & sufficient space under the DIN rail
- Screwless Earth and Neutral Terminals for outgoing loads increases the speed of installation
- Flexibility in installation:
 - Position of Door on left or right for multirow row enclosures brings adaptability in tight corners
 - Position of Earth/Neutral bar can be interchanged to top or bottom to allow flexibility
 - Multiple cable entry/exit knock-outs
- Removable DIN rail assembly brings in the adaptability to organize the cables in position before mounting the devices



MX9E3218S

Surface Mount Enclosures

Catalogue No.	Description	No of Rows	No of Modules
MX9E3218S	2 rows, 36 ways, Surface mounted	2	36
MX9E3318S	3 rows, 54 ways, Surface mounted	3	54



MX9E3218S

Flush Mount Enclosures

Catalogue No.	Description	No of Rows	No of Modules
MX9E3218F	2 rows, 36 ways, Flush mounted	2	36
MX9E3318F	3 rows, 54 ways, Flush mounted	3	54

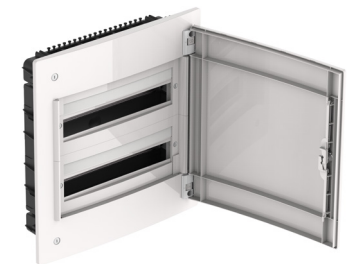

MX9E3218F

Technical Data

Main characteristics	Type 3
Rated current	100A
Rated voltage	240/ 440 V
Rated Insulation voltage	500 V
IP Rating - Door Closed	IP4X
IK Rating	IK09
Color	RAL9003 White
Space between DIN rails	150mm
Isolation Class	2
Pole filler supplied	4 strips (20 modules)
Green label supplied	2 sheet
Compliance to Distribution boards standard	AS NZS 61439-3
Supports the Compliance to Wiring regulations	AS NZS 3000

Surface Mount Enclosures

Catalogue No.	Encl. Height (H) mm	Encl. Width (W) mm	Encl. Depth (D) mm	No. of tunnels x Max cable size						Knockout dim. and location		
				Earth Bar			Neutral Bar			Back	Top / Bottom	
				50 mm ²	25 mm ²	6 mm ²	50 mm ²	25 mm ²	6 mm ²	Single KO Ø80mm x40mm	Double KO Ø20mm x23mm Ø32mm x 29mm	Double KO Ø25mm x 40mm Ø40mm x40mm
MX9E3218S	450	426	145	1	2	36	1	2	36	6	Flexible	Flexible
MX9E3318S	600	426	145	1	2	60	1	2	60	8	Flexible	Flexible

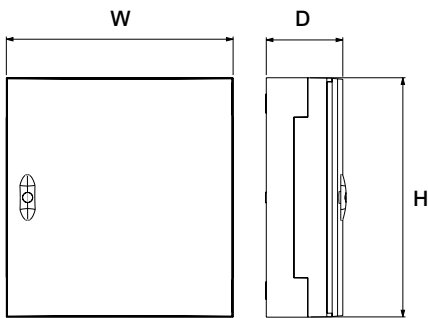

Flush Mount Enclosures

Catalogue No.	Encl. Height (H) mm	Encl. Width (W) mm	Encl. Depth (D) mm	Back Box Height (b)	Back Box Width (a)	Back Box Depth (c)	No. of tunnels x Max cable size						Knockout dim.			
							Earth Bar			Neutral Bar			Back	Top / Bottom		Side
							50 mm ²	25 mm ²	6 mm ²	50 mm ²	25 mm ²	6 mm ²	Single KO Ø80mm x40mm	Double KO Ø20mm x 23mm Ø32mm x 29mm	Double KO Ø25mm x 40mm Ø40mm x40mm	Single KO Ø40mm x40mm
MX9E3218F	510	486	128	480	456	72	1	2	36	1	2	36	12	4	8	3
MX9E3318F	660	486	128	630	456	72	1	2	60	1	2	60	12	4	8	4

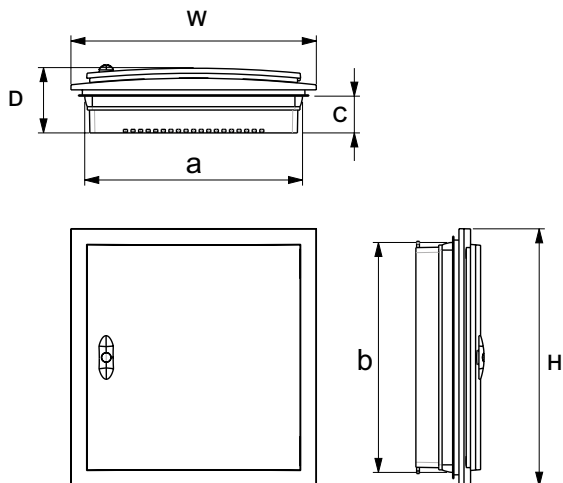

Plastic consumer switchboards

Weatherproof surface mount enclosures

MAX9 range provides several weatherproof enclosures to help prevent ingress of dust and water. These enclosures are ideal for damp areas such as laundries and kitchens. IP56 rated enclosures help to provide highest ingress protection and are therefore even suitable for washdown areas.

Features and benefits:

- IP56 rated enclosures help to provide highest ingress protection and are therefore suitable for wet areas
- Peace of mind with Type tested system as per AS/NZS 61439-3.
- Extra wiring space with 135 mm Space between the DIN rails and sufficient space under the DIN rail.
- Flexibility in installation:
 - Position of Door on left or right for multirow row enclosures brings adaptability in tight corners
 - Reversible back box for multirow enclosures allows flexibility to choose the position on Earth/Neutral bar to your style.
 - Multiple cable entry/exit knock-outs
- Removable DIN rail Brings to help organise the cables in position before mounting the devices.
- Ample Earth & neutral terminals to suit your typical configurations and comply to MEN type system.



MX9EW212S

Surface Mount Enclosures

Catalogue No.	Description	No of Rows	No of Modules
MX9EW212S	2 rows, 24 ways, Surface mounted	2	24
MX9EW312S	3 rows, 36 ways, Surface mounted	3	36



MX9EW212S

Technical Data

Main characteristics	Type 3
Rated current	100A
Rated voltage	240/ 440 V
Rated Insulation voltage	500 V
IP Rating - Door Closed	IP56
IK Rating	IK07
Color	RAL9003 White
Space between DIN rails	135mm
Isolation Class	2
Pole filler supplied	2 strips (16 modules)
Green label supplied	1 sheet for 2 row 2 sheet for 3 row
Compliance to Distribution boards standard	AS NZS 61439-3
Supports the Compliance to Wiring regulations	AS NZS 3000

Catalogue No.	Encl. Height (H) mm	Encl. Width (W) mm	Encl. Depth (D) mm	No. of tunnels x Max cable size				Knockout dim.	
				Earth Bar		Neutral Bar		Back	Top / Bottom
				16 mm ²	35 mm ²	16 mm ²	35 mm ²	Triple KOØ40mm x Ø32mm x Ø25mm	Triple KOØ40mm x Ø32mm x Ø25mm
MX9EW212S	426	345.5	109.5	24	1	25	2	8	8
MX9EW312S	560	345.5	109.5	39	2	25	2	12	-

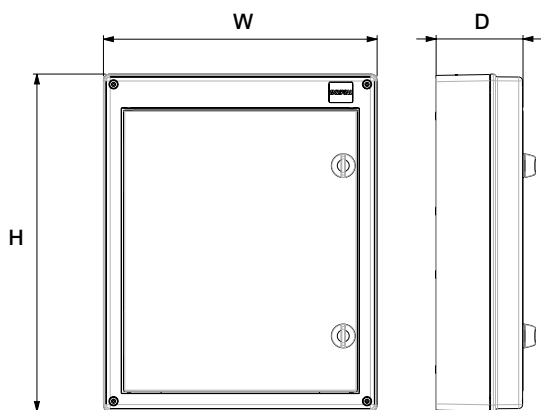

MAXBAR - One bar delivers it all

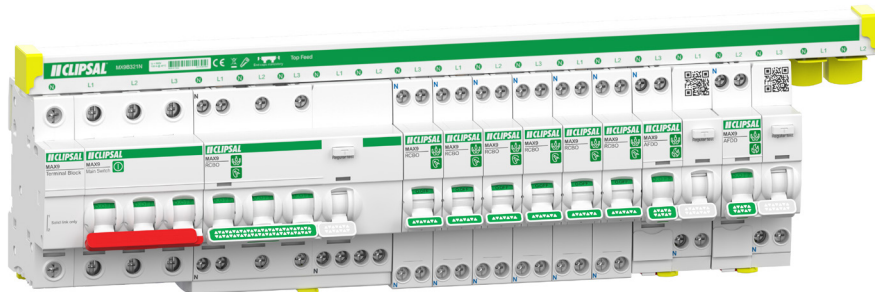

MAX PROFESSIONAL

No cables for feeding RCBOs

MAX SPEED

Up to 15 times faster installation speed
Compared to connecting with cables

MAX FLEXIBILITY

One busbar connects to main switch,
all type of Clipsal RCBOs and AFDD

MAX PERFORMANCE

100A rated system

MAXBAR is easy to order with all the accessories, like cable connector, end caps, teeth covers, neutral terminal block, needed for a switchboard installation coming in a kit package.

MAXBAR Kit definition

There are two type of MAXBAR kits

MAXBAR with Neutral Terminal Block Kit – MX9BxxxN

For installation in all single row enclosure or row with main incomer in case of multi-row enclosures.

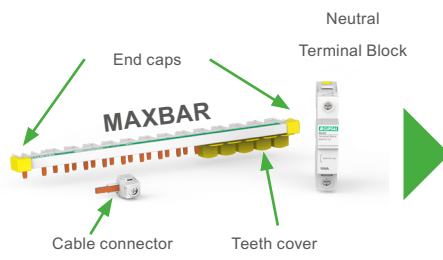

MAXBAR without Neutral Terminal Block Kit – MX9Bxxx

For installation in rows without main incomer in case of multi-row enclosures.

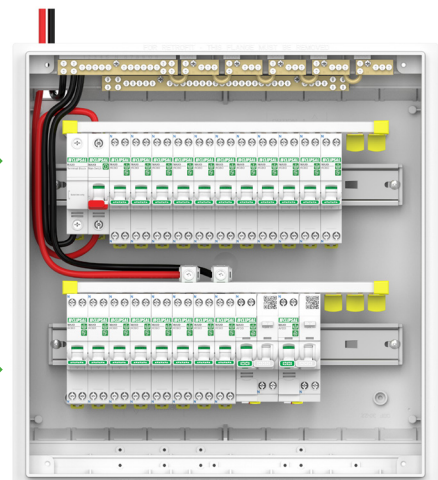
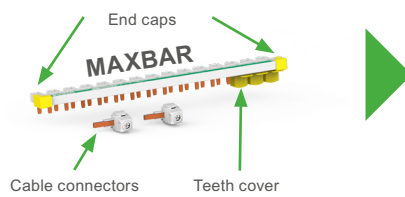

Catalog number format and legend

MX9	FN	BC	D
Range name MX9 – MAX9	Function B1 – Busbar for 1P+N B3 – Busbar for 3P+N	Total Module Width 12 15 21	Special Function (if needed) N – Busbar with Neutral terminal block

Features and benefits:

- MAX Speed – Up to 15 times faster compared to traditional wiring method
- MAX Professionalism – No cables for feeding RCBOs
- MAX Performance – 100A rated
- MAX Ease – All in 1 pack: Busbar + Connector + Teeth cover + End Caps + Neutral terminal block (refs ending with N only)
- MAX Flexibility
 - One busbar connects to main switch, all type of Clipsal RCBOs and AFDD
 - Cuttable to have desired number of modules and insulate with End caps
 - Teeth covers to insulate unused modules for future upgrades
 - Available in varying lengths
 - Compatible with Resi MAX SLIM Comb busbar accessories like connector and teeth cover

Technical Data

Main characteristics	Type 3
Rated current	100A at 40°C
Rated voltage	240/ 440 V
Rated Insulation voltage	500 V
IP Rating	IP2X with Tooth caps

MAXBAR with Neutral Terminal Block & Accessories – For Rows with Main Incomer

Catalogue No.	Description	Phase	No of Ways	Neutral Terminal Block	Cable Connector	Teeth Cover	End Caps
MX9B112N	1P+N , 12 ways with Neutral Block & accessories	1 Phase	12	1	1	4	-
MX9B115N	1P+N , 15 ways with Neutral Block & accessories	1 Phase	15	1	1	5	-
MX9B121N	1P+N , 21 ways with Neutral Block & accessories	1 Phase	21	1	1	6	2
MX9B315N	3P+N , 15 ways with Neutral Block & accessories	3 Phase	15	1	1	5	
MX9B321N	3P+N , 21 ways with Neutral Block & accessories	3 Phase	21	1	1	6	2

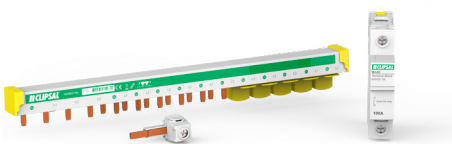

MAXBAR with Accessories – For Rows without Main Incomer

Catalogue No.	Description	Phase	No of Ways	Neutral Terminal Block	Cable Connector	Teeth Cover	End Caps
MX9B112	1P+N , 12 ways with accessories	1 Phase	12	0	2	2	-
MX9B115	1P+N , 15 ways with accessories	1 Phase	15	0	2	3	-
MX9B315	3P+N , 15 ways with accessories	3 Phase	15	0	4	3	2

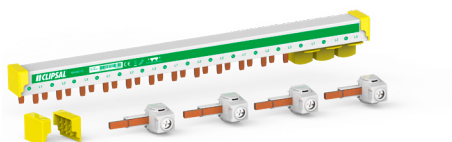

MAX9 System

Peace of mind with type tested system

MAX9 system has been designed to help ensure quality, reliability and peace of mind for your installation. It has been internally type tested as per AS/NZS 61439-3 at accredited labs by Schneider Electric.

Summary of key tests

- Strength of materials: Resistance to corrosion, Resistance to abnormal heat and fire, Mechanical Impacts
- Clearance and Creepage: Insulation voltage
- Degree of protection in enclosures: Protection against dust and water,
- Protection against electric shock: Earthing continuity, Dielectric strength, Impulse voltage
- Temperature rise limits: Thermal Performance of the system

Accessories

Accessories

MAX9

Accessories

Clipsal MAX9 offers a full range of innovative accessories to complement the extensive circuit protection range.

This includes changeover switches, DIN mounted socket outlets, contactors, pole fillers, locking accessories and circuit identification labels.

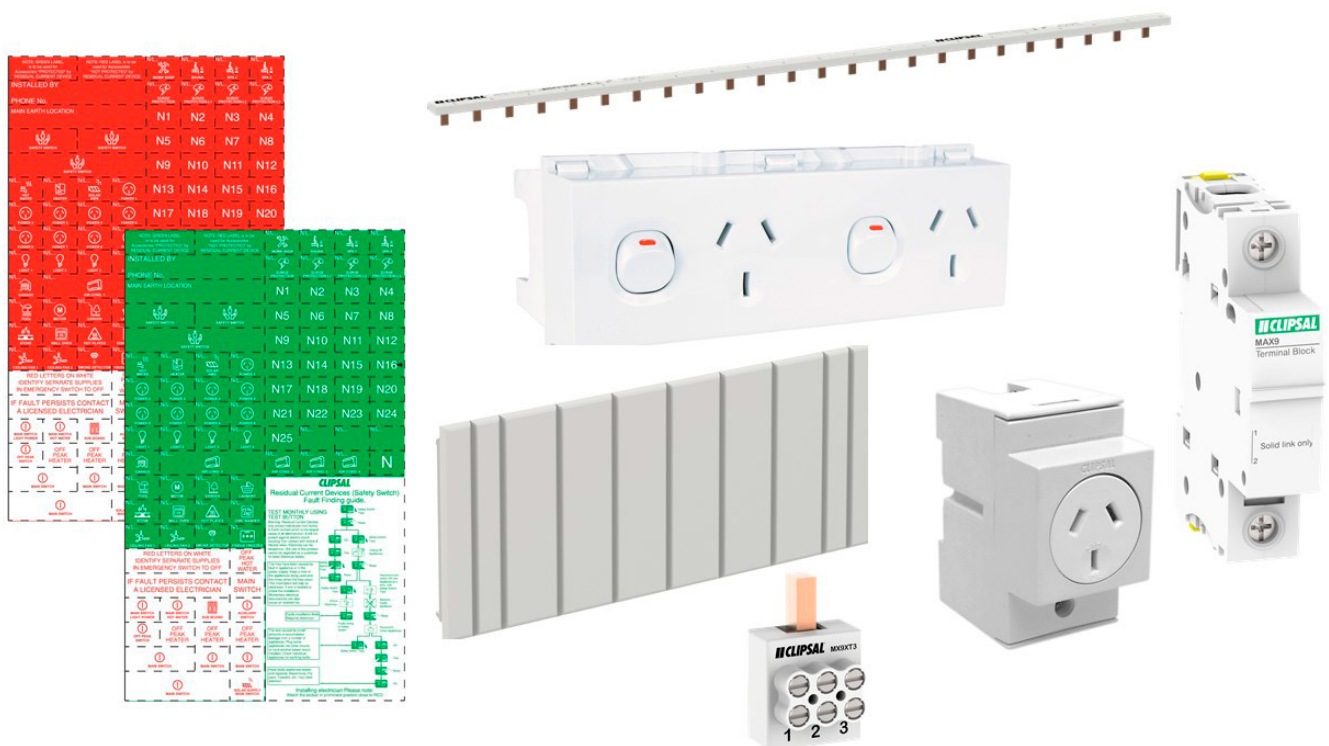

Changeover Switches

Six single-pole and one double-pole changeover switches are available, rated from 25 to 63 amperes.

Applications:

- Night, off, day switching of luminaries where daylight supplements internal lighting.
- Auto, off, manual switching of machines.
- Auxiliary, off, mains switching of small stand-by generators.

Incoming and outgoing terminals are screw down type and accommodate copper conductors up to 16mm².

1-Pole, 1-Module, 415V

Night, off, day changeover switch

Catalogue No.	
4PS25CO	25A
4PS40CO	40A
4PS63CO	63A

1-Pole, 1-Module, 415V

Auto, off, manual changeover switch

Catalogue No.	
4PS40COA	40A

1-Pole, 1-Module, 415V

Auxiliary, off, manual changeover switch

Catalogue No.	
4PS40CAM	40A
4PS63CAM	63A



4PS25CO

Dimensions (mm)

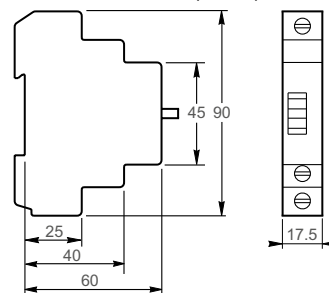

Accessories

MAX9

Busbar for RCCB & MCB type installations

Main characteristics	Comb busbar
Rated Current	100A
Rated voltage	240/ 440 V
Rated Insulation voltage	500 V



MX9B124P

Busbar with Accessories

Catalogue No.	Description	Phase	No of Ways	Busbar End cap
MX9B157P	Clipsal PIN Type COMB BUSBAR 1P 57	1 Phase	57	10
MX9B124P	Clipsal PIN Type COMB BUSBAR 1P 24	1 Phase	24	2
MX9B256P	Clipsal PIN Type COMB BUSBAR 2P 56	2 Phase	56	10
MX9B357P	Clipsal PIN Type COMB BUSBAR 3P 57	3 Phase	57	10

Socket Outlets

The 4SSO series DIN rail mounted socket outlet sockets are particularly useful when used in power supply applications such as temporary power on building sites, additional outlets in switchboards or meter enclosures. This range is available in both four and eight module wide units and features easy access to terminals for quick fit-off.

The 4SSO series also features extra strong mounting brackets for extra strength in aggressive temporary power supply applications. This coupled with the use of the Clipsal 15 Series Mechanism, means that you can expect years of dependable service from these sockets.

Switched Socket Outlets

Catalogue No.	Description
4SSO15D	250V 10A 3 pin socket double-pole, 4 modules
4SSO15D15	250V 15A 3 pin socket double-pole, 4 modules
4SSO25D	250V 10A 3 pin twin socket double-pole, 8 modules



4SSO15



4SSO25D

Socket Outlets

Catalogue No.	Description
4PSO10	250V 10A 3 pin socket outlet, 2.5 modules
4PSO10D	250V 10A 3 pin socket double-pole, 2.5 modules
4PSO10DL	250V 10A 3 pin socket outlet double-pole with round Earth socket, 2.5 modules
4PSO15D	250V 15A 3 pin socket double-pole, 2.5 modules
4PSO20D	250V 20A 3 pin socket outlet double-pole, 2.5 modules
4PS31	Enclosure only accepts any 30 Series switch mechanisms, 2.5 modules



4PSO10

Accessories

MAX9

Contactors

Complementing the MAX9 is a range of contactors.

They are rated from 25A 1 and 2 module, through to 63A 4 pole 54mm devices.

The 1 and 2 pole devices are ideal for hot water service control.

1 and 2-Pole, 1-Module, 240V

Catalogue No.	AC7a	AC6b	Ue	Uc	Contact N/O	Contact N/C	Consumption Holding
MX9C112510	25	8.5 A	240	240	1	-	2.7VA
MX9C112520	25	8.5 A	240	240	2	-	2.7VA
MX9C112511	25	8.5 A	240	240	1	1	2.7VA
MX9C212510	25	8.5 A	240	24	1	-	3.8VA
MX9C212520	25	8.5 A	240	24	2	-	3.8VA



MX9C112510 **MX9C112520** **MX9C112511**

4-Pole, 2 Modules, 415V

Catalogue No.	AC7a	AC6b	Ue	Uc	Contact N/O	Contact N/C	Consumption Holding
MX9C122540	25	8.5 A	415	240	4	-	4.6VA
MX9C122522	25	8.5 A	415	240	2	2	4.6VA



MX9C122540

MX9C122522

4-Pole, 3 Modules, 415V

Catalogue No.	AC7a	AC6b	Ue	Uc	Contact N/O	Contact N/C	Consumption Holding
MX9C136340	63	20 A	415	240	4	-	6.5VA

Refer to "Technical Information" for more load characteristics.



MX9C136340

Connection

Control	25A	10 mm	0.5 - 6 mm ²	0.5 - 4 mm ²	0.8 N.m	4 mm PZ1
	63A	10 mm	2 x (0.5 - 2.5) mm ²	2 x (0.5 - 2.5) mm ²	0.8 N.m	4 mm PZ1
Power	25A	10 mm	1.5 - 6 mm ²	1.5 - 4 mm ²	0.8 N.m	4 mm PZ1
	63A	14 mm	6 - 25 mm ²	6 - 16 mm ²	3.5 N.m	6 mm PZ2

Dimensions (mm)

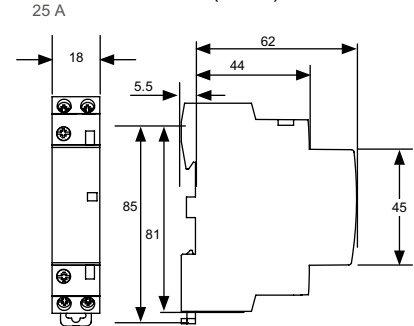

Technical Data

Main characteristics		
Voltage rating (Ue)	1P, 2P	240V a.c.
	4P	415V a.c.
Frequency		50Hz
Endurance (O-C)		
Electrical		100,000 cycles
Maximum number of switching operations a day		100
Additional characteristics		
Insulation voltage (Ui)		500V a.c.
Pollution degree		2
Rated impulse withstand voltage (Uimp)		2.5kV (4kV for 24V a.c.)
Degree of protection (IEC 60529)	Device only	IP20
	Device in modular enclosure	IP40
Operating temperature		-25°C to +70°C (Derating table and extra spacer refer to technical information)
Storage temperature		-40°C to 70°C
Tropicalisation (IEC 60068-1)		Severity B (relative humidity 95% at 55°C)
ELSV compliance (extra low safety voltage) for 12/24/48V a.c. versions		
The product conforms to the SELV (safety extra low voltage) requirements		

If multiple iCTs side by side: install spacer and apply 0.8 coefficient on upper current values.

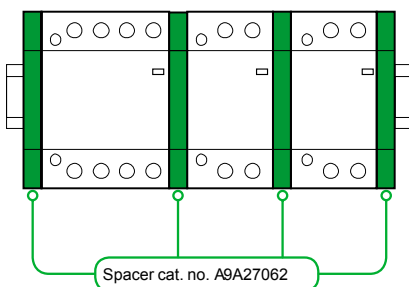

Dimensions (mm)

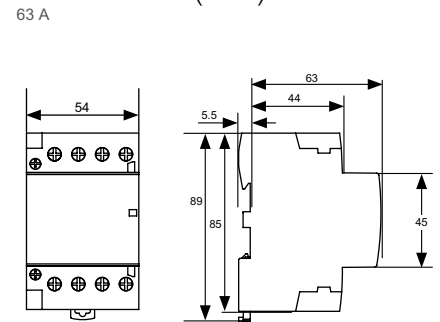

Accessories

MAX9

Mains Rated Filters

Mains rated filters help to provide additional overvoltage protection to sensitive electronic equipment such as computers, home theatre, microwaves and televisions.

The 970MF10 and 970F20 work in conjunction with the Surge Protection Devices by providing additional filtering to slow down the rate of rise of a voltage spike.

Whereas the Surge Protection Devices typically clamp the voltage spike to values less than 1kV, the rate of rise of the voltage spike remains unchanged.

The additional filtering provided by the Mains Rated Filters considerably slows down the rate of rise to further protect electronic equipment.

2-Module, 250V

Catalogue No.	Description
970MF10	Mains rated filter, 10A

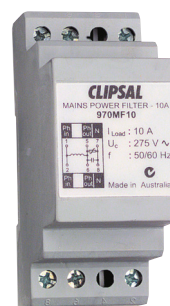

970MF10

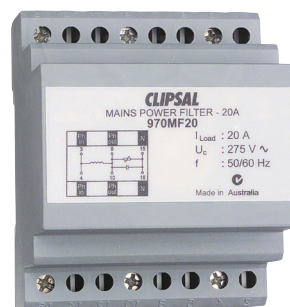

4-Module, 250V

Catalogue No.	Description
970MF20	Mains rated filter, 20A



970MF20

Connection

Rating	Tightening torque	Copper cables	
		Rigid/semi rigid	Flexible or ferrule
			
10 to 20	2 Nm	1.5 to 2.5mm ²	1.5 to 2.5mm ²

Technical Data (With 970 Surge Arrester)

Main characteristics	970MF10	970MF20	
Maximum continuous operating voltage (Uc)	275Vrms		
Load current ILoad	10A	20A	
Operating temperature	0-55°C		
Conductor size	1.5 – 6mm ²		
Mounting	30mm DIN rail		
Let through at 3kA, 8/20µS	<800V	<720V	
Rate of voltage rise at 20kA, 8/20µS	<100V/µS	<50V/µS	
Let through at 3kA, 8/20µS	<820V	<720V	
Rate of voltage rise at 20kA, 8/20µS	<120V/µS	<100/µS	
Frequency bandwidth	<20kHz		
Test performance – typical			
Let through voltage			
6kV3kA, 8/20µS	811V	711V	700V
6kV20kA, 8/20µS	1109V	797V	750V
Rate of rise (dV/dt)			
6kV3kA, 8/20µS	6919V/µS	83.4V/µS	36.1V/µS
6kV20kA, 8/20µS	5378V/µS	106.9V/µS	49.8V/µS
Current pulse applied L to N			

Accessories

MAX9

Locking devices

Locking device

Catalogue No.	Description
4LD	Locking device for MAX9 circuit breakers, isolating switches and RCDs (lockable in ON and OFF position). Suits padlocks with shafts up to 6mm.
A9A26970	Locking device for MAX9 devices except RCBO SLIM, lockable in ON or OFF position, with padlock diameter up to 6mm.
26970	Locking device for MAX9 RCBO SLIM, lockable in ON or OFF position, with padlock diameter up to 8mm.

*Locking in ON position does not prevent tripping of the breaker in the event of faults



A9A26970



4LD



26970

MAX9 Enclosure Accessories

Pole Filler Blanks

Catalogue No.	Description
MX9EF8	Enclosure Pole Filler 6x1 modules wide, 4x1/2 modules wide.



MX9EF8

RCD Neutral Terminal

Catalogue No.	Description
MX9XT3	3x16mm Neutral link to suit terminating RCD Neutrals.



MX9XT3

Circuit Identification Labels

Catalogue No.	Description
MX9ELG	Green labels for RCD protected circuits
MX9ELR	Red labels for non-RCD protected circuits

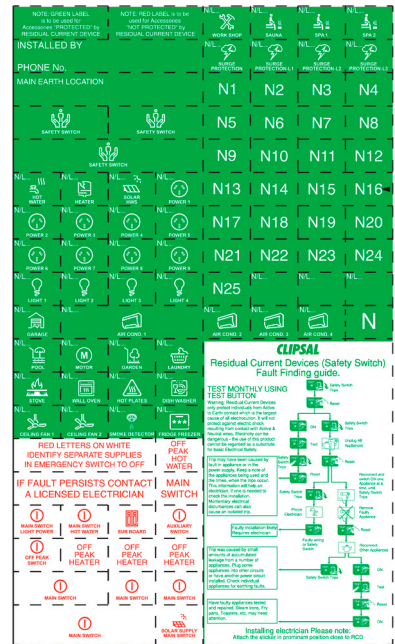

MX9ELG

Neutral Terminal Block

Catalogue No.	Description
MXTB1100	100A Neutral terminal block



MXTB1100

Accessories

MAX9

Causes of Tripping

Tripping causes fall into three broad categories:

- Installation causes.
- Appliance causes.
- External causes.

Installation Causes:

1. Low impedance between Neutral and Earth

This is the most common cause of tripping and can be broken down into the following varieties:

- Second MEN point Neutral and Earth physically bonded together in a backyard shed or other secondary site.
- Earth and Neutral wires are exchanged at the terminals of a GPO.
- Neutral to Earth short – by penetration of cable e.g. a nail driven through a Neutral connecting to Earth or through contact with foil insulation.
- Lowered impedance due to contamination of air gaps. e.g. bridging of air insulation gaps by insects, water or other contaminants, typically found in exposed terminals of junction boxes, batten holders, etc. This may also be seen as an Active to Earth fault.
- Neutral to Earth low impedance with Neutral voltage present. This fault, while being under the category of Neutral to Earth low impedance, is peculiar because the voltage present on the Neutral is likely to cause the RCD to trip, even with the load disconnected. **Note:** If no Neutral potential was present, nuisance tripping would not occur until the load current is drawn.

2. Cable Insulation Deterioration

This most commonly occurs in older insulation where VIR and TRS cables can exhibit residual current in excess of 20mA.

3. Crossed Neutrals

These occur where a Neutral from an unprotected circuit is used as the load 'return' from an Active, which is protected by an RCD or vice versa.

4. Incorrect wiring of the RCDs

This occurs when the RCD Neutral connections are taken from the wrong side, e.g. the Neutral is coming from the line side rather than the load side, yet the Active still comes through the correct load side.

Appliance causes

By far the most common cause of an appliance induced residual current occurs where the appliance has a reduced impedance value between Active and Earth or Neutral and Earth, often due to moisture.

Metal sheathed heating elements absorb moisture which can result in substantially reduced impedances and residual currents flowing when they are first energised.

Some typical appliances which develop these problems are refrigerator defrost elements, evaporative elements, stove elements, hot water services and washing machine heating elements.

Another possible cause is 'tracking', which can be caused by food particle contaminants in toasters and mini ovens, an accumulation of lint in irons and washing machines, and carbon or graphite dust or filings in power tools.

Accumulation of residual currents.

All appliances can have some minor leakage level. If a number of appliances are covered by one RCD the accumulative effect can cause the RCD to trip.

Special impedances

This can result from Earth and Neutral being bounced by capacitors, inductors or resistors in computer equipment or communications equipment, causing a residual current.

External causes

A lightning strike causing insulation breakdown and mains current to flow is the most likely cause of tripping from an external source.

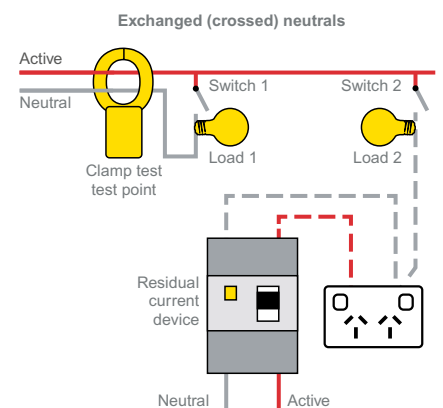
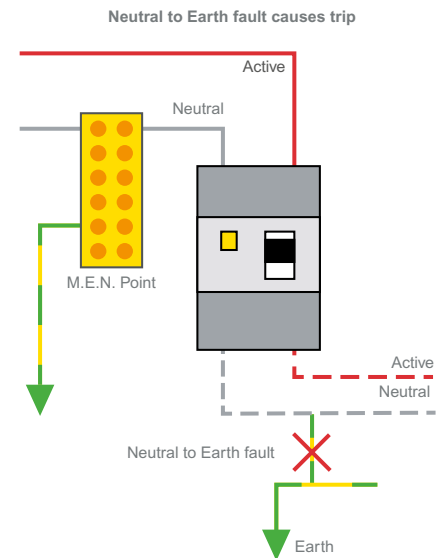

Accessories

MAX9

Spark-e-mate

The Clipsal Spark-e-mate performs comprehensive electrical wiring tests relevant to Australian and New Zealand Standards from socket outlets, to the switchboard. Why waste your precious time finding the correct instrument to test installations? The Clipsal Spark-e-mate has you tested and covered. One instrument does it all. Testing with Spark-e-mate is easy. Simply plug into outlet or Active, Neutral and Earth. Select a function. Then record and report the results.

Features and benefits:

Clipsal's Spark-e-mate can test for:

- Earth continuity.
- Insulation resistance.
- Polarity.
- Correct circuit connections.
- Earth fault loop impedance (without tripping RCDs).
- Residual current device (earth leakage detector or safety switch).
- Extension leads and power accessories.
- Supply voltage.
- Mains frequency.



493

Technical Data

Main characteristics	493
Enclosure	Hammond 1599HBK, ABS fire retardant rating UL94HB, IP-54 rated
Dimensions (H x W x D)	220mm x 110mm x 45mm.
Label	EBG180 autoflex textured satin polycarbonate, automotive grade
Holster	Santoprene thermoplastic vulcanizate rubber, PANTONE 115U (Yellow)
Operating Temperature Range	-10 to 50°C ambient
Storage Temperature Range	-20 to 70°C ambient
Humidity, Storage and Operating	To 98% non-condensing
Mean Time Between Failure	> 20 years.
Control Logic	PIC 18LF8722, 128K bytes internal program flash memory, 4K bytes RAM, 1K bytes EEPROM
Indicators	Graphical liquid crystal display 122 (H) x 64 (V) pixels
Connector	IEC mains socket
Power Lead	CAT# PS-4106 power cord mains plug to IEC320-C13. Other plugs to order.
Testing Criteria	AS/NZS 3000:2007, section 8 – verification
Earth Continuity Test	Earth impedance in powered mode derived from mains power. In unpowered mode from an internal battery. Range 0. to 15Ω. Display accuracy $\pm 0.1\Omega \pm 2\%$
Insulation Resistance Test	Active to Earth insulation resistance derived from an internally generated 250V d.c. or 500V d.c. -10%/+20% applied across a 1MΩ load. At 250V nominal range 20kΩ to 10MΩ and at 500V nominal 250kΩ to 20MΩ. Accuracy $\pm 2\%$ at 1MΩ decreasing to $\pm 5\%$ at extremes of range. Voltage accuracy $\pm 1V \pm 2\%$
Polarity	Polarity Correct, A&N reversed, A&E reversed, no Neutral, no Earth
Correct Circuit Connections	Circuit checks OK, Earth hazard – load or short between Earth and live conductor, detect threshold of $\geq 70V$ a.c. potential on Earth with respect to surroundings detection method.
Earth Fault Loop Test	Current applied between Active and Earth from mains when available or internal battery when unpowered. (RCD should nottrip*1). Range 0 to 20Ω. Display accuracy $\pm 0.1\Omega \pm 2\%$
RCD Test	5, 10, 15, 30 and 150mA nominal between Active and Earth. Range 2 to 300ms trip time Display accuracy $\pm 2ms$
Mains Supply Indicator	RMS meter readout accuracy $\pm 1V \pm 2\%$, 1Hz display resolution
Battery Condition Indicator	Battery symbol on the LCD, vertical bars indicate state
Field Programming	Bluetooth to RS232C optional, authorised partners only
Factory Programming	Via host computer (RS232C)
Nominal Power Requirement	230V a.c. $\pm 10.9\%$, 50Hz $\pm 12Hz$ (other voltages to order)
Abs. Minimum Power input	150V a.c.
Abs. Maximum Power input	300V a.c.
Power Consumption	0mA off, 30mA nominal, up to 150mA depending on test
Internal Batteries	6 x AA alkaline
Auto Turn-off	Backlight after 30 seconds, shutdown after 60 seconds
Unpacked Weight	610gms
Warranty	Two years
Quality Assurance Certification	ISO9001
RoHS	Compliant
Electrical Safety Compliance (non-prescribed)	AS/NZS3300, AS/NZS3017, AS/NZS3260 (AS/NZS60950), AS/NZS3100, AS/NZS3350.1, AS/NZS61010.1 category III
ACMA Compliance	Design 2000 Pty Ltd ACMA supplier's code N468
EMC Compliance	AS/NZS CISPR 22
Human Rights Australia	Privacy commissioner assent 89/328



Technical Information

Technical Information

To assist you with circuit protection selection and identification Clipsal provide an extensive range of wiring options and technical tables. And to help find critical information, these tables are referenced in individual sub-sections.

These sub-sections include:

- On-site fault finding guide.
- Circuit protection trip unit variations.
- Circuit breaker limitation capacity.
- Tripping curves.
- Derating tables.
- Circuit supplementary protectors.
- Lighting, heating and small motor application categories.
- Circuit breaker selection.
- Fuse back-up protection.
- Power formulas and common conversion factors.

Technical Information

MAX9

Electricians On-Site Fault Finding Guide

When you arrive at a customer's house, talk to them and find out what they were doing when the RCD tripped.

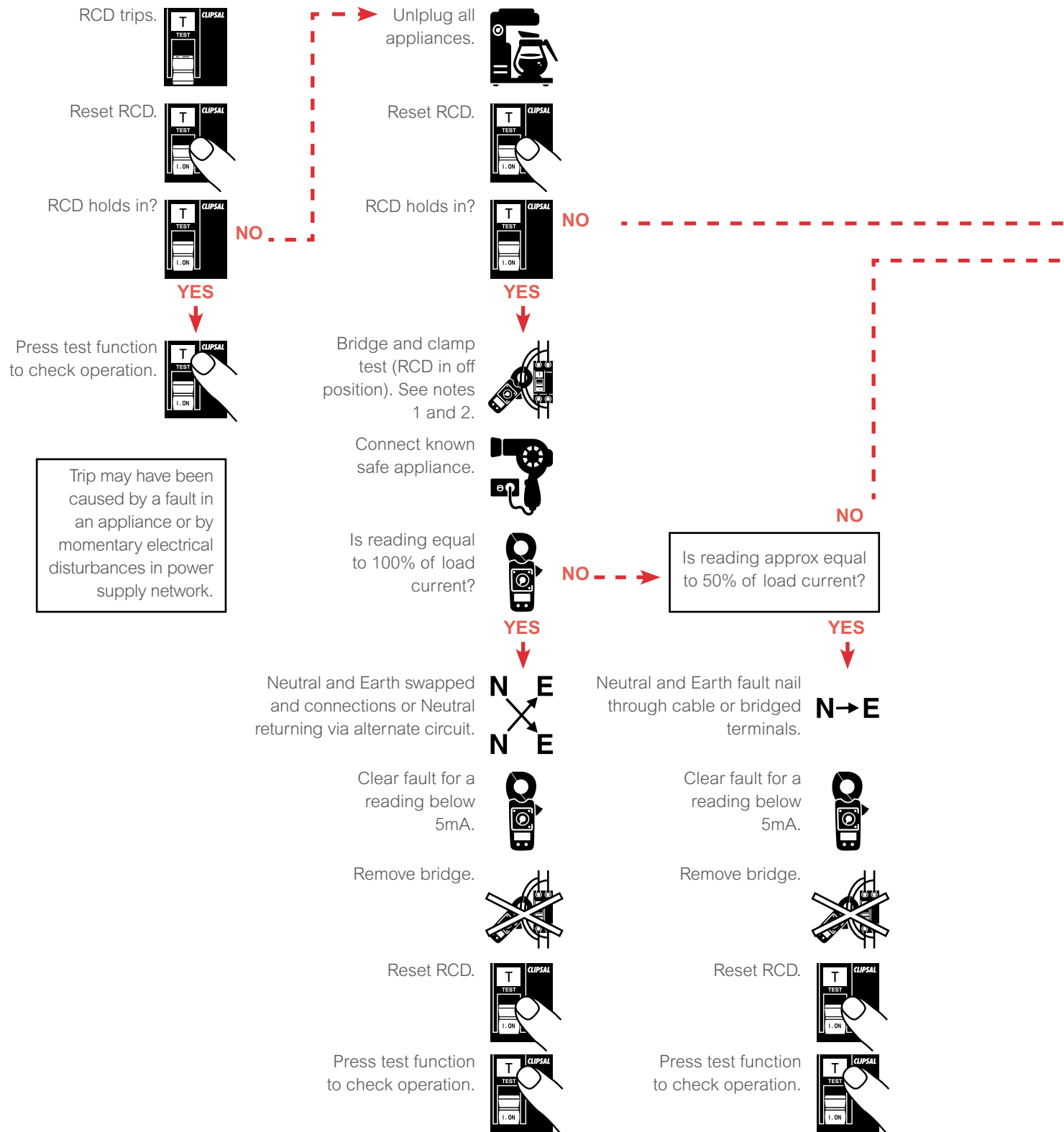

NOTE 1: Bridging of combination RCDs with over current protection, negates that function and may result in fusing the main fuse with faulty wiring. Note that in these instances, fault currents could be significantly higher and suitable precautions should be taken.

NOTE 2: Under no circumstances should the press to test function be utilised while an RCD is bridged.

NOTE 3: Insulation breakdown could be alternatively identified by the Clipsal 491 Insulation Tester.

Remember to test regularly

RCDs should be tested monthly by operating their inbuilt test button. You should remind the customer of this.

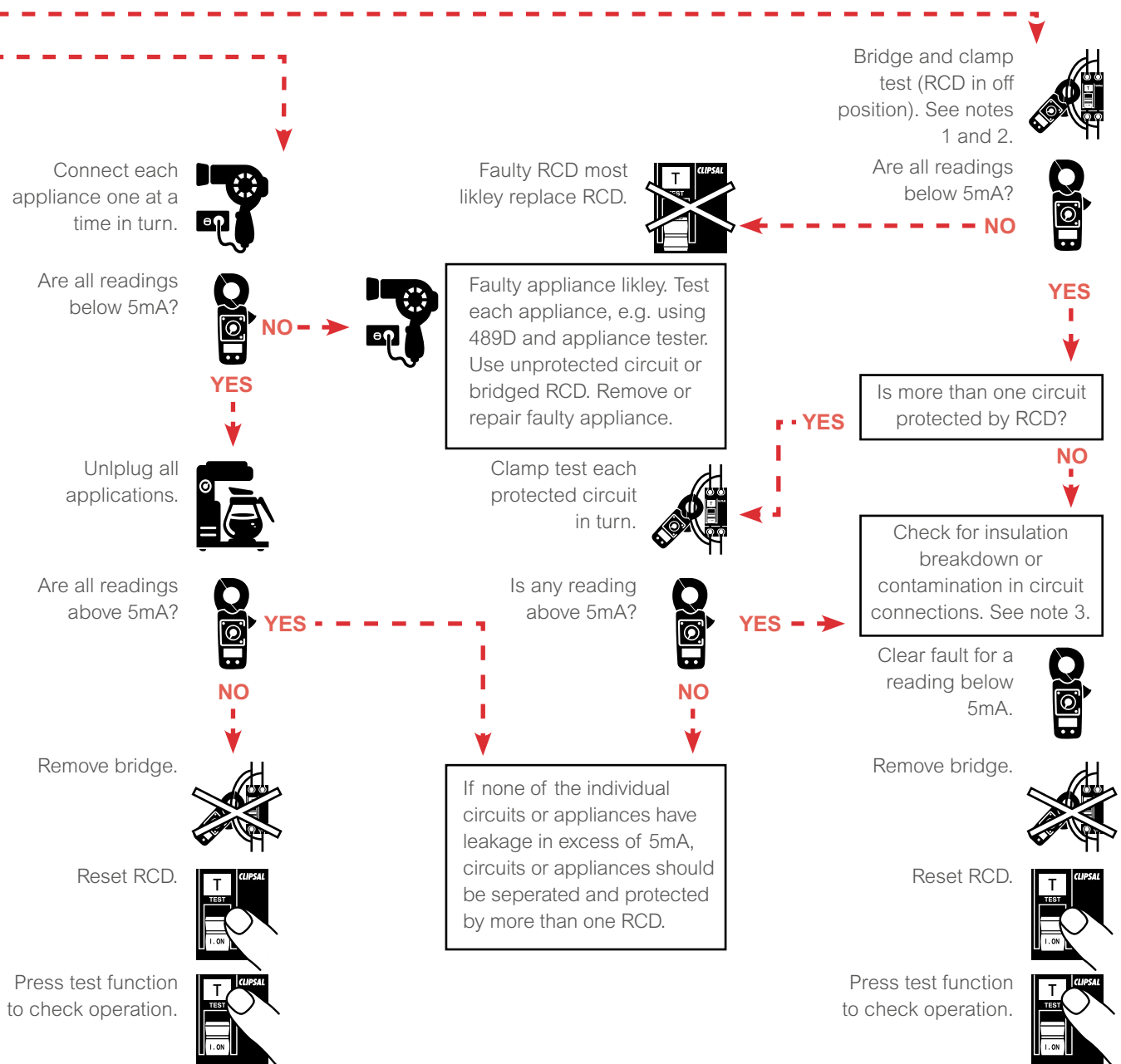

Technical Information

MAX9

Circuit Protection Trip Unit Variations

A choice of several curves. Whatever circuit has to be protected, a circuit breaker provides the perfect solution with a suitable curve.

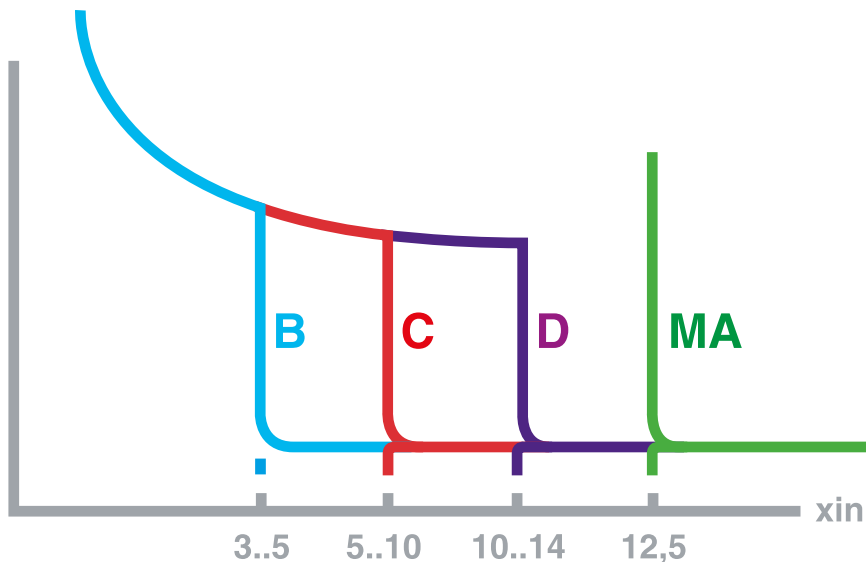

B-Curve tripping

3 to 5 times the rated current (I_n); protection of generators, persons, very long cables.



C-Curve tripping

5 to 10 I_n ; protection of circuits, general applications.



D-Curve tripping

10 to 14 I_n ; protection of high surge circuits, welders, transformers, motors.



MA-Curve (magnetic only) tripping

12 I_n ; protection of motor starters (+ thermal protection when combined with contactor).

Circuit Breaker Limitation Capability

The limitation capability of a circuit breaker is that characteristic whereby only a current less than the prospective fault current is allowed to flow under short circuit conditions.

This is illustrated by limitation curves which give:

- the limited peak current in relation to the RMS value of the prospective short circuit current (the short circuit current being that current, which would flow continuously in the absence of protection equipment).
- the limited current stress in relation to the RMS value of the prospective shortcircuit current.
- current limiting capability.

The advanced design of the MAX9 range provides current limitation with far better protection than conventional circuit breakers. For example, on a 6A rating with a prospective short circuit of 5000A, the current will be limited at 350A or 7%.

Installation of current limiting circuit breakers offers several advantages:

- **Better network protection**
Current limiting circuit breakers considerably reduce the undesirable effects of short circuit currents in an installation.
- **Reduced thermal effects**
Cable heating is reduced, hence longer cable life.
- **Reduced mechanical effects**
Electrodynamic forces reduced, thus electrical contacts are less likely to be deformed or broken.
- **Reduced electromagnetic effects**
Measuring equipment situated near an electrical circuit less affected.

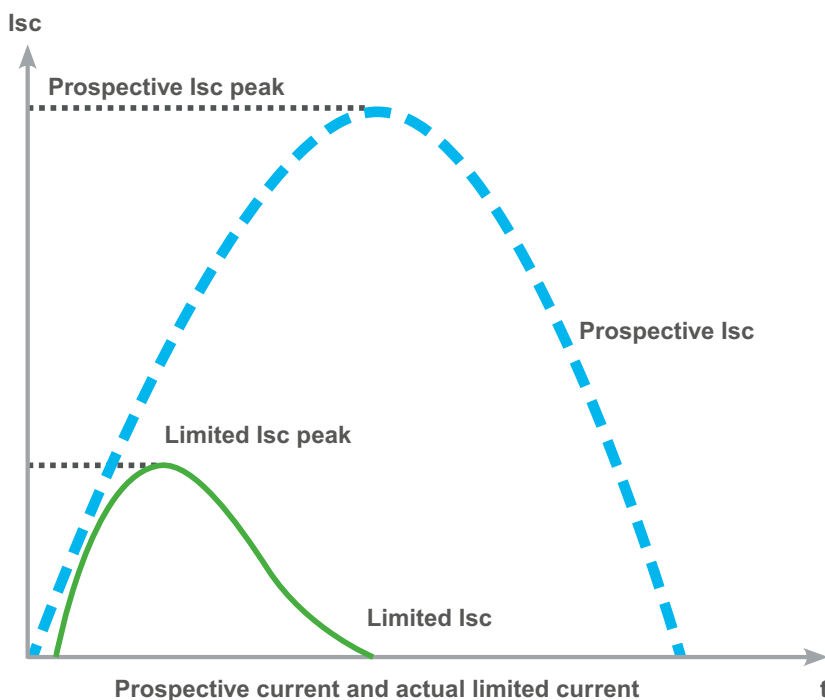

Technical Information

MAX9

Tripping Curves

The operating range of the magnetic release is as follows:

- For B-curve: between 3 In and 5 In
- For C-curve: between 5 In and 10 In
- For D-curve: between 10 In and 14 In.

The curves show the cold thermal tripping limits when poles are charged and the electromagnetic tripping limits with 2 charged poles.

Curves

MCB

According to AS/NZS 60898

Curve C

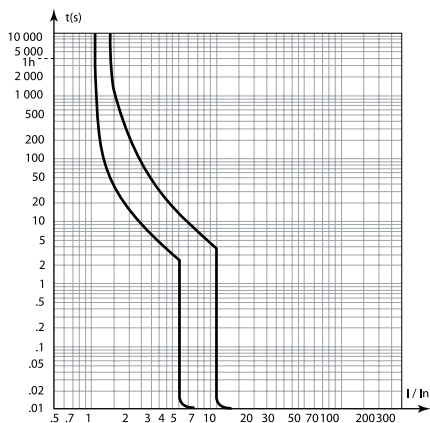

RCBO

According to AS/NZS 60898
(reference temperature 30°C)

Curves B, C, D

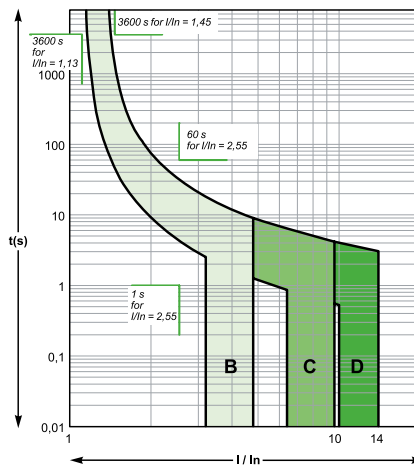

Thermal Derating Tables

MCB18 Derating Table (according to AS/NZS 60898.1)

MAX9 MCB Ambient temperature (°C)																				
Rating	-25°C	-20°C	-15°C	-10°C	-5°C	0°C	5°C	10°C	15°C	20°C	25°C	30°C	35°C	40°C	45°C	50°C	55°C	60°C	65°C	70°C
2 A	2.45	2.41	2.37	2.34	2.3	2.26	2.22	2.17	2.13	2.09	2.04	2	1.95	1.91	1.86	1.81	1.76	1.71	1.65	1.59
4 A	4.92	4.84	4.77	4.69	4.61	4.53	4.44	4.36	4.27	4.18	4.09	4	3.91	3.81	3.71	3.61	3.5	3.39	3.28	3.17
6 A	7.44	7.32	7.2	7.07	6.95	6.82	6.69	6.56	6.42	6.29	6.14	6	5.85	5.7	5.54	5.38	5.22	5.04	4.87	4.68
10 A	11.9	11.8	11.6	11.4	11.3	11.1	10.9	10.8	10.6	10.4	10.2	10	9.8	9.6	9.4	9.2	9	8.8	8.5	8.3
16 A	19	18.7	18.5	18.2	18	17.7	17.4	17.1	16.9	16.6	16.3	16	15.7	15.4	15.1	14.8	14.5	14.1	13.8	13.4
20 A	23.5	23.2	22.9	22.6	22.3	22	21.7	21.4	21	20.7	20.4	20	19.7	19.3	18.9	18.6	18.2	17.8	17.4	17
25 A	29.1	28.8	28.4	28	27.7	27.3	26.9	26.6	26.2	25.8	25.4	25	24.6	24.2	23.8	23.3	22.9	22.5	22	21.5
32 A	37.9	37.4	36.9	36.4	35.9	35.3	34.8	34.3	33.7	33.2	32.6	32	31.4	30.8	30.2	29.6	28.9	28.3	27.6	26.9
40 A	47.4	46.7	46.1	45.5	44.8	44.2	43.5	42.8	42.1	41.4	40.7	40	39.3	38.5	37.7	37	36.2	35.3	34.5	33.6
50 A	59.9	59.1	58.2	57.4	56.5	55.6	54.7	53.8	52.9	52	51	50	49	48	46.9	45.9	44.8	43.6	42.5	41.3
63 A	76.4	75.3	74.1	73	71.8	70.6	69.4	68.2	66.9	65.6	64.3	63	61.6	60.3	58.8	57.4	55.9	54.3	52.8	51.1

RCBO 1P+N 1-Module Derating Table (according to AS/NZS 61009.1)

Ambient temperature (°C)																				
Rating	-25°C	-20°C	-15°C	-10°C	-5°C	0°C	5°C	10°C	15°C	20°C	25°C	30°C	35°C	40°C	45°C	50°C	55°C	60°C	65°C	70°C
6 A	7.92	7.76	7.60	7.44	7.28	7.11	6.94	6.76	6.58	6.39	6.20	6.00	5.79	5.58	5.36	5.13	4.89	4.63	4.36	4.06
10 A	12.08	11.91	11.73	11.55	11.37	11.18	11.00	10.80	10.61	10.41	10.21	10.00	9.79	9.57	9.35	9.13	8.89	8.66	8.41	8.16
16 A	19.15	18.89	18.62	18.35	18.07	17.79	17.50	17.21	16.92	16.62	16.31	16.00	15.68	15.36	15.03	14.69	14.34	13.98	13.62	13.24
20 A	24.00	23.67	23.33	22.98	22.63	22.27	21.91	21.54	21.17	20.79	20.40	20.00	19.60	19.18	18.76	18.33	17.89	17.43	16.97	16.49
25 A	30.00	29.58	29.16	28.73	28.29	27.84	27.39	26.93	26.46	25.98	25.50	25.00	24.49	23.98	23.45	22.91	22.36	21.79	21.21	20.61
32 A	37.69	37.21	36.72	36.23	35.73	35.22	34.70	34.18	33.15	33.11	32.56	32.00	31.43	30.85	30.26	29.66	29.05	28.42	27.42	27.12

RCBO 1P+N 2-Module Derating Table (according to AS/NZS 61009.1)

Ambient temperature (°C)																				
Rating	-25°C	-20°C	-15°C	-10°C	-5°C	0°C	5°C	10°C	15°C	20°C	25°C	30°C	35°C	40°C	45°C	50°C	55°C	60°C	65°C	70°C
6 A	7.7	7.6	7.4	7.3	7.2	7.0	6.8	6.7	6.5	6.4	6.2	6.0	5.9	5.8	5.6	5.5	5.4	5.2	5.1	4.9
10 A	12.0	11.8	11.6	11.5	11.3	11.1	10.9	10.8	10.6	10.4	10.2	10.0	9.8	9.6	9.4	9.2	9.0	8.8	8.5	8.2
16 A	19.6	19.3	19.0	18.7	18.4	18.1	17.7	17.4	17.1	16.7	16.4	16.0	15.6	15.3	14.9	14.5	14.1	13.6	13.2	12.7
20 A	23.8	23.5	23.2	22.8	22.5	22.2	21.8	21.5	21.1	20.7	20.4	20.0	19.6	19.2	18.8	18.4	18.0	17.6	17.1	16.7
25 A	29.5	29.2	28.8	28.4	28.0	27.6	27.2	26.7	26.3	25.9	25.4	25.0	24.5	24.1	23.6	23.1	22.6	22.1	21.6	21.1
32 A	39.4	38.7	38.1	37.5	36.9	36.2	35.5	34.9	34.2	33.5	32.7	32.0	28.7	28.0	27.3	26.6	25.8	25.0	24.2	23.3
40 A	50.2	49.3	48.5	47.6	46.7	45.8	44.9	44.0	43.0	42.0	41.0	40.0	35.0	34.1	33.1	32.0	31.0	29.8	28.7	27.5

Technical Information

MAX9

RCBO 3P+N 5-Module Derating Table (according to AS/NZS 61009.1)

Ambient temperature (°C)																				
Rating	-25°C	-20°C	-15°C	-10°C	-5°C	0°C	5°C	10°C	15°C	20°C	25°C	30°C	35°C	40°C	45°C	50°C	55°C	60°C	65°C	70°C
10 A	12.1	12.0	11.8	11.6	11.4	11.2	11.0	10.8	10.6	10.4	10.2	10.0	9.8	9.6	9.3	9.1	8.9	8.6	8.4	8.1
16 A	19.1	18.8	18.6	18.3	18.0	17.8	17.5	17.2	16.9	16.6	16.3	16.0	15.7	15.4	15.0	14.7	14.4	14.0	13.7	13.3
20 A	23.8	23.5	23.1	22.8	22.5	22.1	21.8	21.5	21.1	20.7	20.4	20.0	19.6	19.2	18.8	18.4	18.0	17.6	17.2	16.7
25 A	29.2	28.8	28.4	28.1	27.7	27.3	27.0	26.6	26.2	25.8	25.4	25.0	24.6	24.2	23.7	23.3	22.9	22.4	22.0	21.5
32 A	38.0	37.5	37.0	36.4	35.9	35.4	34.8	34.3	33.7	33.2	32.6	32.0	31.4	30.8	30.2	29.5	28.9	28.2	27.5	26.8
40 A	47.9	47.2	46.6	45.9	45.2	44.5	43.8	43.0	42.3	41.6	40.8	40.0	39.2	38.4	37.6	36.7	35.8	34.9	34.0	33.1

AFDD Derating Table (according to AS/NZS 61009.1)

Ambient temperature (°C)																				
Rating	-25°C	-20°C	-15°C	-10°C	-5°C	0°C	5°C	10°C	15°C	20°C	25°C	30°C	35°C	40°C	45°C	50°C	55°C	60°C	65°C	70°C
6 A	7.7	7.6	7.4	7.3	7.2	7.0	6.8	6.7	6.5	6.4	6.2	6.0	5.9	5.8	5.6	5.5	5.4	5.2	5.1	4.9
10 A	12.0	11.8	11.6	11.5	11.3	11.1	10.9	10.8	10.6	10.4	10.2	10	9.8	9.6	9.4	9.2	9.0	8.8	8.5	8.2
16 A	19.6	19.3	19.0	18.7	18.4	18.1	17.7	17.4	17.1	16.7	16.4	16	15.6	15.3	14.9	14.5	14.1	13.6	13.2	12.7
20 A	23.8	23.5	23.2	22.8	22.5	22.2	21.8	21.5	21.1	20.7	20.4	20	19.6	19.2	18.8	18.4	18.0	17.6	17.1	16.7
25 A	29.5	29.2	28.8	28.4	28.0	27.6	27.2	26.7	26.3	25.9	25.4	25	24.5	24.1	23.6	23.1	22.6	22.1	21.6	21.1

RCCB Derating Table

Ambient temperature (°C)							
Rating	40	45	50	55	60	65	70
40 A	40	37.5	35	32.5	30	27.5	25
63 A	63	58.5	55	51.3	47.5	44	40.5

Contactors Derating Table

Ambient temperature (°C)					
Rating	30	40	50	60	70
25 A	25	25	23.7	20	18.7
63 A	63	63	59.8	50.4	47.2

Lighting Application AC5a and AC5b Categories

- The following tables are relevant to all the contactors from the CT range, with or without manual control, for 230V single-phase lighting circuits.
- They indicate the contactor rating to be chosen according to the number and type of lamps to be controlled. As a guideline, maximum power is also given.

To obtain an equivalence on:

- Three-phase + Neutral circuits: multiply the number of lamps and the power indicated in the table by 3.
- Three-phase without Neutral circuits: multiply the number of lamps and the power indicated in the table by 1.7.

Choice table

Products		iCT contactors			
Type of lamp		Maximum number of light fittings for a single-phase circuit and maximum power output per circuit			
		25 A		63 A	
Basic incandescent lamps, LV halogen lamps, replacement mercury vapour lamps (without ballast)					
	40 W	57	2300 W to 2850 W	172	6900 W to 7500 W
	60 W	45		125	
	75 W	38		100	
	100 W	28		73	
ELV 12 or 24 V halogen lamps					
With ferromagnetic transformer	20 W	23	450 W to 900 W	63	1250 W to 2850 W
	50 W	15		42	
	75 W	12		35	
	100 W	8		27	
With electronic transformer	20 W	90	1850 W to 2250 W	275	5500 W to 6000 W
	50 W	39		114	
	75 W	28		78	
	100 W	22		60	
Fluorescent tubes with starter and ferromagnetic ballast					
1 tube without compensation ⁽¹⁾	15 W	30	450 W to 1200 W	100	1500 W to 3850 W
	18 W	30		100	
	20 W	30		100	
	36 W	28		90	
	40 W	28		90	
	58 W	17		56	
	65 W	17		56	
	80 W	15		48	
	115 W	10		32	
1 tube with parallel compensation ⁽²⁾	15 W	5 µF	300 W to 1200 W	60	900 W to 3500 W
	18 W	5 µF		60	
	20 W	5 µF		60	
	36 W	5 µF		60	
	40 W	5 µF		60	
	58 W	7 µF		43	
	65 W	7 µF		43	
	80 W	7 µF		43	
	115 W	16 µF		20	

Technical Information

MAX9

Products		iCT contactors			
Type of lamp		Maximum number of light fittings for a single-phase circuit and maximum power output per circuit			
		25 A		63 A	
Fluorescent tubes with starter and ferromagnetic ballast					
2 or 4 tubes with series compensation	2 x 18 W		46		123
	4 x 18 W		24		68
	2 x 36 W		24	1650 W to 2400 W	68
	2 x 58 W		16		42
	2 x 65 W		16		42
	2 x 80 W		13		34
	2 x 115 W		10		25
					4450 W to 5900 W
Fluorescent tubes with electronic ballast					
1 or 2 tubes	18 W		46		123
	36 W		24		68
	58 W		24	2000 W to 2200 W	68
	2 x 18 W		16		42
	2 x 36 W		16		42
	2 x 58 W		13		34
Compact fluorescent lamps					
With external electronic ballast	5 W		330		
	7 W		222	1650 W to 2000 W	
	9 W		194		
	11 W		163		
	18 W		105		
	26 W		76		
With integral electronic ballast (replacement for incandescent lamps)	5 W		230		710
	7 W		164	1150 W to 1300 W	514
	9 W		133		411
	11 W		109		340
	18 W		69		213
	26 W		50		151
LED lamps					
With driver	10 W		69		200
	30 W		54	700 W to 1950 W	157
	50 W		39		114
	75 W		25		73
	150 W		12		37
	200 W		9		31
Low-pressure sodium vapour lamps with ferromagnetic ballast with external ignitor					
Without compensation ⁽¹⁾	35 W		9	320 W to 720 W	200
	55 W		9		157
	90 W		6		114
	135 W		4		73
	180 W		4		37
					850 W to 1800 W
With parallel compensation ⁽²⁾	35 W	20 µF	9	175 W to 360 W	200
	55 W	20 µF	9		157
	90 W	26 µF	6		114
	135 W	40 µF	4		73
	180 W	540µF	4		37
					550 W to 1100 W

Products		iCT contactors			
Type of lamp		Maximum number of light fittings for a single-phase circuit and maximum power output per circuit			
		25 A		63 A	
High-pressure sodium vapour lamps					
Metal-iodide lamps					
With ferromagnetic ballast with external ignitor, without compensation ⁽¹⁾	35 W		24		64
	70 W		12		32
	150 W		7	850 W to 1200 W	18
	250 W		4		11
	400 W		3		8
	1000 W		1		3
With ferromagnetic ballast with external ignitor and parallel compensation ⁽²⁾	35 W	6 µF	18	650 W to 2000 W	50
	70 W	12 µF	9		25
	150 W	20 µF	6		15
	250 W	32 µF	4		10
	400 W	45 µF	3		7
	1000 W	60 µF	2		5
	2000 W	85 µF	1		3
With electronic ballast	35 W		38	1350 W to 2200 W	102
	70 W		29		76
	150 W		14		40

(1) Circuits with non-compensated ferromagnetic ballasts consume twice as much current for a given lamp power output. This explains the small number of lamps in this configuration.

(2) The total capacitance of the power factor correction capacitors in parallel in a circuit limits the number of lamps that can be controlled by a contactor. The total downstream capacitance of a modular contactor of rating 16, 25, 40 or 63 A should not exceed 75, 100, 200 or 300 µF respectively. Allow for these limits to calculate the maximum acceptable number of lamps if the capacitance values are different from those in the table.

Technical Information

MAX9

Heating Application AC7a and AC1 Categories

- The following table concerns all the contactors in the CT range, with or without manual control, for 230V single-phase and 400V three-phase heating circuits.
- It indicates the contactor rating to be chosen according to the power to be controlled and the number of operations a day.

Heating applications

230 V heating		
Type of heating application	Maximum power for a given rating iCT contactors	
Number of operations / day	25 A	63 A
25	5.4 kW	14 kW
50	5.4 kW	14 kW
75	4.6 kW	12 kW
100	4 kW	9.5 kW
250	2.5 kW	6 kW
500	1.7 kW	4.5 kW
400V heating		
25	16 kW	41 kW
50	16 kW	41 kW
75	14 kW	35 kW
100	11 kW	26 kW
250	5 kW	13 kW
500	3.5 kW	9 kW

Small Motor Application

- The following table concerns all the contactors in the CT range, with or without manual control, for 230V single-phase and 400V three-phase circuits.
- It indicates the contactor rating to be chosen according to the power of the motor to be controlled.

Small motor applications

Asynchronous single-phase motor with capacitor		
Small motor application type	Maximum power for a given rating iCT contactors	
Voltage	25 A	63 A
230 V	1.4	4
Asynchronous three-phase motor		
400 V	4	15
Asynchronous three-phase motor		
230 V	0.9	2.2

Circuit Breaker Selection

For high efficiency motors (high inrush currents) please contact a Clipsal sales representative. See back cover for details.

For Direct On-Line

FLC AMPS	a.c.-3 kW	MCB C-Curve
1.1	0.37	4
1.5	0.55	4
1.8	0.75	6
2.6	1.1	6
3.4	1.5	10
4	1.5	10
5	2.2	16
6-7	3	20
8	3.7	20
9	4-4.5	25
10		25
11	5.5	32
12		32
13		32
14	7.5	40
15		40
16-17	9-9.2	40
18-19	10	50
20-22	11	63
23-24		63
25-28	15	63
29-32		
33-38	18.5	
39-44	22	
45-52	25	
53-56	30	
57-60	34	
61-68	37	

For Star Delta, Auto Transformer and Resistor/Reactance

FLC AMPS	a.c.-3 kW	MCB C-Curve
1.1	0.37	6
1.5	0.55	6
1.8	0.75	6
2.6	1.1	6
3.4	1.5	6
4	1.5	6
5	2.2	10
6-7	3	10
8	3.7	16
9	4-4.5	16
10		20
11	5.5	20
12		20
13		25
14	7.5	25
15		32
16-17	9-9.2	32
18-19	10	32
20-22	11	40
23-24		40
25-28	15	50
29-32		63
33-38	18.5	63
39-44	22	
45-52	25	
53-56	30	
57-60	34	
61-68	37	
69-72		
73-80	45	
81-100	55	

For more information on MAX9 and other Clipsal products, contact your local Clipsal and Schneider Electric Partner Business Representative, electrical wholesaler or visit clipsal.com/MAX9



Schneider Electric (Australia) Pty. Ltd.
33-37 Port Wakefield Road,
Gepps Cross, South Australia, 5094

Consumer Support Enquiries
Phone: 1300 669 925
Website: clipsal.com/contactus

National Customer Care (trade only)
Phone: 1300 369 233

clipsal.com/MAX9

Life Is  On

