

FASTENERS

E1271 BEAM CLAMP

506kg Working Load when used in pairs.

Box Qty: **10**

Available Finish	Part Number	Service Guide
H	E1271H	A
S	E1271S	A

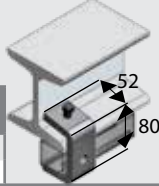

E1272 BEAM CLAMP

373kg Working Load when used in pairs.

Box Qty: **25**

Available Finish	Part Number	Service Guide
H	E1272H	A
S	E1272S	A

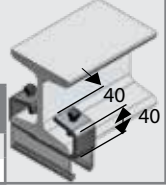

STRUT SYSTEMS

E1386 BEAM CLAMP

440kg Working Load when used in pairs.

Box Qty: **50**

Available Finish	Part Number	Service Guide
H	E1386H	A
S	E1386S	A

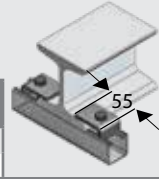

E1796 BEAM CLAMP

509kg Working Load when used in pairs.

Box Qty: **5**

Available Finish	Part Number	Service Guide
H	E1796H	A
S	E1796S	A

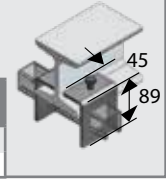

CABLE SUPPORTS

E2785 BEAM CLAMP

407kg Working Load when used in pairs.

Box Qty: **10**

Available Finish	Part Number	Service Guide
H	E2785H	A
S	E2785S	A

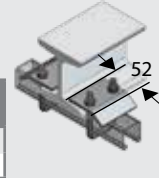

E2786 BEAM CLAMP

407kg Working Load when used in pairs.

Box Qty: **10**

Available Finish	Part Number	Service Guide
H	E2786H	A
S	E2786S	A

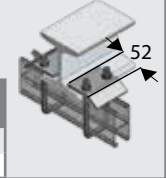

FIRERATED

E3087 BEAM CLAMP

Slip Load: **398kg**

Box Qty: **5**

Available Finish	Part Number	Service Guide
H	E3087H	A
S	E3087S	A

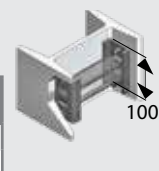

FOLDED BEAM CLAMP

E2675 Working Load when used in pairs is **565kg** and Box Qty **20**.

E2676 Working Load when used in pairs is **615kg** and Box Qty **15**.

Threaded Rod	Hot Dip Galvanised	Stainless Steel
M10	E2675H A	-
M12	E2676H A	E2676S B

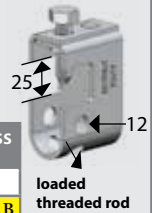

PIPE SUPPORTS

EBC BEAM CLAMP

EBC10 Working Load when used in pairs is **150kg** and Box Qty **20**.

EBC12 Working Load when used in pairs is **250kg** and Box Qty **15**.

Threaded Rod	A	Hot Dip Galvanised	Zinc Plated
M10	44	EBC10H A	EBC10Z A
M12	54	EBC12H A	-

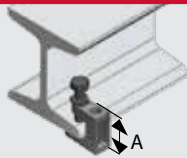

EPC BEAM CLAMP

EPC10 Working Load when used in pairs is **102kg** and Box Qty **10**.

EPC12 Working Load when used in pairs is **108kg** and Box Qty **10**.

Threaded Rod	A	Hot Dip Galvanised	Zinc Plated
M10	50	EPC10H B	EPC10Z A
M12	54	-	EPC12Z A

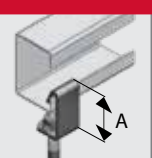

SINGLE CHANNEL ROLLER

Working Load: **22kg**
Box Qty: **20**



Available Finish	Part Number	Service Guide
Z	E2749Z	A

DOUBLE CHANNEL ROLLER

Working Load: **44kg**
Box Qty: **20**

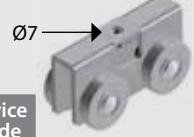

Available Finish	Part Number	Service Guide
Z	E2750Z	A

FASTENERS

FLAT PLATE FITTING (1 HOLE)

40mm width
Box Qty: **50**

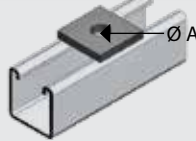

Ø A	Hot Dip Galvanised	Stainless Steel
M8	E1062H A	E1062S B
M10	E1063H A	E1063S A
M12	E1064H A	E1064S A
M16	E1964H A	E1964S C

E2324 FLAT PLATE FITTING

14mm hole diameter

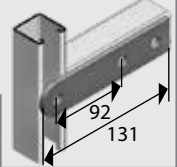

Available Finish	Part Number	Service Guide
H	E2324H	A

STRUT SYSTEMS

FLAT PLATE FITTING (2-5 HOLES)

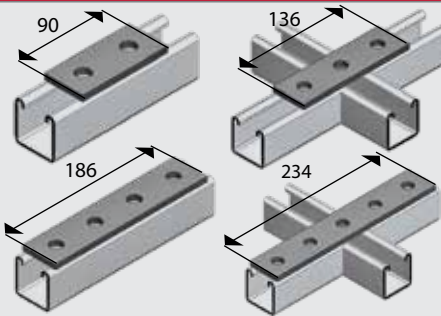

40mm width and 14mm hole diameter.
20.5mm hole spacing from the end
(47.5mm on centres).

Length (mm)	Box Qty	Hot Dip Galvanised	Stainless Steel
90	30	E1065H A	E1065S B
136	20	E1066H A	E1066S B
186	20	E1067H A	E1067S B
234	10	E1941H A	E1941S C

E1358 FLAT PLATE FITTING

14mm hole diameter
Box Qty: **10**

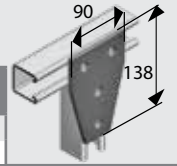

Available Finish	Part Number	Service Guide
H	E1358H	A
S	E1358S	C

CABLE SUPPORTS

E1031 FLAT PLATE FITTING

14mm hole diameter
Box Qty: **10**

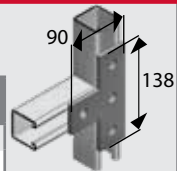

Available Finish	Part Number	Service Guide
H	E1031H	A
S	E1031S	B

FIRERATED

E1036 FLAT PLATE FITTING

14mm hole diameter
Box Qty: **20**

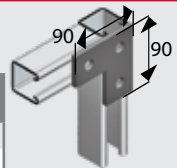

Available Finish	Part Number	Service Guide
H	E1036H	A
S	E1036S	B

PIPE SUPPORTS

FASTENERS

STRUT SYSTEMS

CABLE SUPPORTS

FIRERATED

PIPE SUPPORTS

90° ANGLE FITTING (2-4 HOLES)

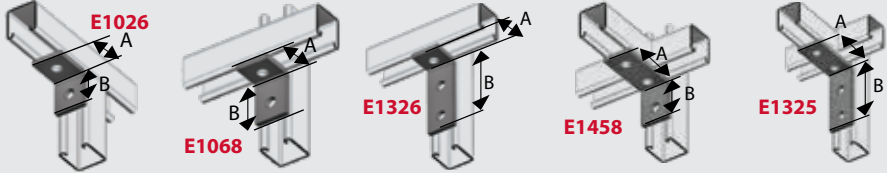

14mm hole diameter

No. Holes	A	B	Box Qty	Hot Dip Galvanised	Stainless Steel
2	48	51	25	E1026H A	E1026S A
	41	57	50	E1068H A	E1068S B
3	41	105	10	E1326H A	E1326S A
	89	57	10	E1458H A	E1458S B
4	89	105	10	E1325H A	E1325S A

E2484 90° ANGLE FITTING

6 hole braced 90° fitting
14mm hole diameter
Box Qty: 5

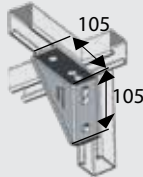

Available Finish	Part Number	Service Guide
H	E2484H	A

E1037 90° ANGLE FITTING

3 hole right hand side 90° fitting
14mm hole diameter
Box Qty: 10

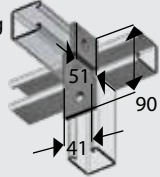

Available Finish	Part Number	Service Guide
H	E1037H	A

E1038 90° ANGLE FITTING

3 hole left hand side 90° fitting
14mm hole diameter
Box Qty: 10

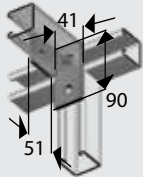

Available Finish	Part Number	Service Guide
H	E1038H	A

E1033 90° ANGLE FITTING

4 hole right hand side 90° fitting
14mm hole diameter
Box Qty: 20

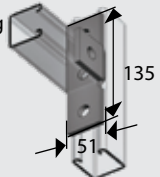

Available Finish	Part Number	Service Guide
H	E1033H	A

E1357 90° ANGLE FITTING

14mm hole diameter
Box Qty: 20

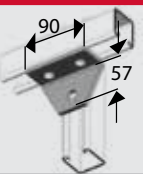

Available Finish	Part Number	Service Guide
H	E1357H	A

E1359 90° ANGLE FITTING

14mm hole diameter
Box Qty: 10

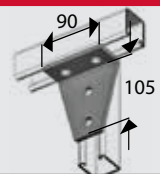

Available Finish	Part Number	Service Guide
H	E1359H	A

E4045 90° ANGLE FITTING

14mm hole diameter
Box Qty: 20

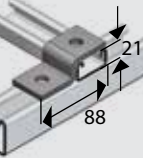

Available Finish	Part Number	Service Guide
H	E4045H	A

E1045 90° ANGLE FITTING

14mm hole diameter
Box Qty: 20

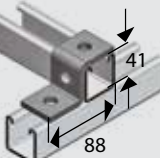

Available Finish	Part Number	Service Guide
H	E1045H	A
S	E1045S	B

Service Guide Key: A Usually in stock at all branches B Usually in stock at head office
C Normal lead time D Made to Order (lead time on enquiry)

E1347 90° ANGLE FITTING

14mm hole diameter

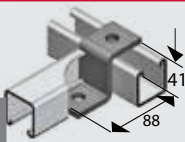

Available Finish	Part Number	Service Guide
H	E1347H	A

E4047 90° ANGLE FITTING

14mm hole diameter
For 21mm high channel.
Box Qty: **15**



Available Finish	Part Number	Service Guide
H	E4047H	A

E1047 90° ANGLE FITTING

14mm hole diameter
Box Qty: **10**

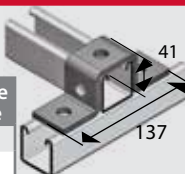

Available Finish	Part Number	Service Guide
H	E1047H	A
S	E1047S	B

E5547 90° ANGLE FITTING

14mm hole diameter
Box Qty: **10**

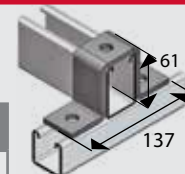

Available Finish	Part Number	Service Guide
H	E5547H	A

E1186 45° ANGLE FITTING

14mm hole diameter
Box Qty: **10**

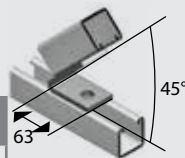

Available Finish	Part Number	Service Guide
H	E1186H	A

E1546 45° ANGLE FITTING

14mm hole diameter
Box Qty: **10**

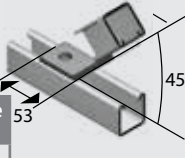

Available Finish	Part Number	Service Guide
H	E1546H	A

E2815 ADJUSTABLE ANGLE FITTING

14mm hole diameter

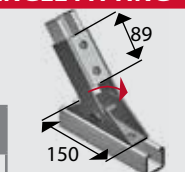

Available Finish	Part Number	Service Guide
H	E2815H	A

E2815D ADJUSTABLE ANGLE FITTING

14mm hole diameter

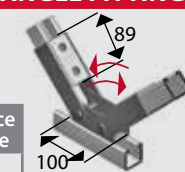

Available Finish	Part Number	Service Guide
H	E2815DH	A

E2452 ANGLE FITTING

14mm hole diameter
Box Qty: **10**

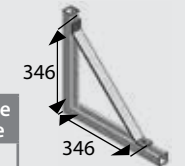

Available Finish	Part Number	Service Guide
H	E2452H	A

SLOTTED ANGLE

3m standard length
Size = Width x Height x Thickness (mm)



Size	Slot	Hot Dip Galvanised	Zinc
25x25x3	25 x 11	EF2500H A	-
30x30x3	25 x 14	EF3000H C	EF3000Z A
50x50x3	25 x 14	EF5000H B	-
50x50x5	25 x 14	EF5005H C	-

EF1510 PLAIN ANGLE

6m standard length

Available as made to order in hot dip galvanised in various width and thickness.

D

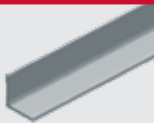

FASTENERS

STRUT SYSTEMS

CABLE SUPPORTS

FIRERATED

PIPE SUPPORTS

E2224 'U' FITTING

14mm hole diameter
Box Qty: 5

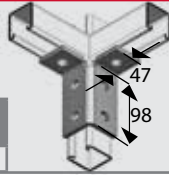

Available Finish	Part Number	Service Guide
H	E2224H	A

E2346 'U' FITTING

14mm hole diameter
Box Qty: 5

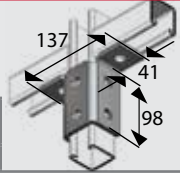

Available Finish	Part Number	Service Guide
H	E2346H	A

E2228 'U' FITTING

14mm hole diameter
Box Qty: 5

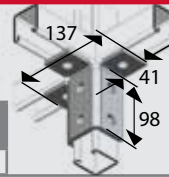

Available Finish	Part Number	Service Guide
H	E2228H	A

E1044 'U' FITTING

14mm hole diameter
Box Qty: 10

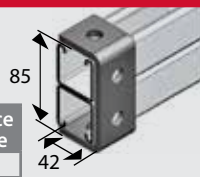

Available Finish	Part Number	Service Guide
H	E1044H	A

E1376 'U' FITTING

14mm hole diameter
Box Qty: 5

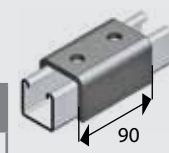

Available Finish	Part Number	Service Guide
H	E1376H	A

E1377 'U' FITTING

14mm hole diameter
Box Qty: 5

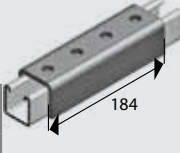

Available Finish	Part Number	Service Guide
H	E1377H	A

E422JINT STRAIGHT CHANNEL JOINER

To join 21mm high channel.
7mm hole diameter.

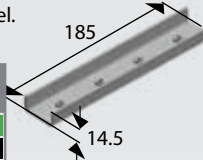

Available Finish	Part Number	Service Guide
H	E422JINTH	A
G	E422JINTG	D

E922JINT STRAIGHT CHANNEL JOINER

Internal joiner for 41mm high channel.
7mm hole diameter.

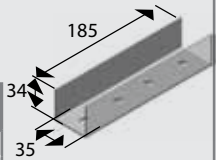

Available Finish	Part Number	Service Guide
H	E922JINTH	A
G	E922JINTG	D

E922JEXT STRAIGHT CHANNEL JOINER

External joiner for 41mm high channel.
7mm hole diameter.

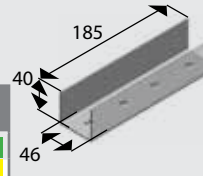

Available Finish	Part Number	Service Guide
H	E922JEXTH	A
G	E922JEXTG	B

E922L ELBOW CHANNEL JOINER

To create a 90° join between channel.
7mm hole diameter.

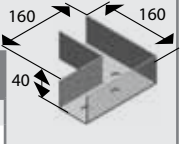

Available Finish	Part Number	Service Guide
H	E922LH	A
Z	E922LZ	D

E922T TEE CHANNEL JOINER

To create a T style join between channel.
7mm hole diameter.

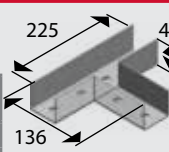

Available Finish	Part Number	Service Guide
H	E922TH	A
Z	E922TZ	D

E922X CROSS CHANNEL JOINER

To create a cross style join between channel.
7mm hole diameter.

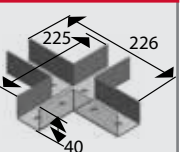

Available Finish	Part Number	Service Guide
H	E922XH	A
Z	E922XZ	D

Service Guide Key: **A** Usually in stock at all branches **B** Usually in stock at head office
C Normal lead time **D** Made to Order (lead time on enquiry)

E2755 CHANNEL HANGER

To suit M12 Threaded Rod.

Available Finish	Part Number	Service Guide
S	E2755S	D
H	E2755H	D
Z	E2755Z	D

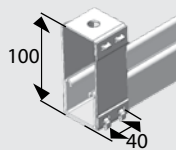

E2855 CHANNEL HANGER

To suit M10 Threaded Rod.

Available Finish	Part Number	Service Guide
S	E2855S	D
H	E2855H	A
Z	E2855Z	A

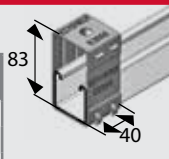

E2539 CHANNEL HANGER

Supplied with PS625 & HN6 for assembly.

Available Finish	Part Number	Service Guide
Z	E2539Z	A

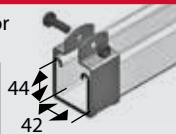

EVMP VERTICAL HANGER

EVMP10 Working Load is **410kg** and Box Qty **25**.

EVMP12 Working Load is **590kg** and Box Qty **25**.

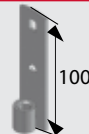

Threaded Rod	Hot Dip Galvanised	Zinc Plated
M10	EVMP10H B	EVMP10Z A
M12	EVMP12H B	EVMP12Z A

ECMP CENTRAL HANGER

ECMP10 Working Load is **327kg** and Box Qty **25**.

ECMP12 Working Load is **480kg** and Box Qty **25**.

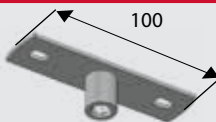

Threaded Rod	Hot Dip Galvanised	Zinc Plated
M10	ECMP10H B	ECMP10Z A
M12	ECMP12H B	ECMP12Z A

EHMP HORIZONTAL HANGER

EHMP10 Working Load is **540kg** and Box Qty **25**.

EHMP12 Working Load is **610kg** and Box Qty **25**.

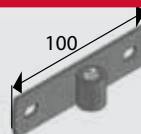

Threaded Rod	Hot Dip Galvanised	Zinc Plated
M10	EHMP10H B	EHMP10Z A
M12	EHMP12H B	EHMP12Z A

BASE PLATE (SINGLE AND DOUBLE CHANNEL)

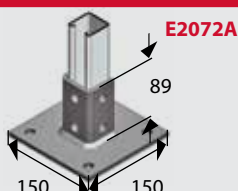
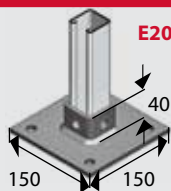

Channel	Collar	Box Qty	Hot Dip Galvanised	Stainless Steel
1 length 41x41mm	40	5	E2072H A	E2072S C
	89	5	E2072AH A	E2072AS A
2 length 41x41mm	40	5	E2073H A	E2073S D

Check out <http://www.ezystrut.com.au/design/using-channels-and-accessories/> for a handy demonstration for working with Channels and Accessories.