

ET EZYTRAY CABLE TRAY



Contact EzyStrut for Load Capability information.

Supplied in 3m lengths

Width (mm)	Pre-Galvanised		Hot Dip Galvanised	
	Weight (kg)	Part No.	Weight (kg)	Part No.
150	3.1/3m	ET150G ▲	3.3/3m	ET150H ▲
300	4.5/3m	ET300G ▲	4.8/3m	ET300H ▲
450	5.9/3m	ET450G ▲	6.3/3m	ET450H ▲
600	7.3/3m	ET600G ▲	7.7/3m	ET600H ▲



ET3 CABLE TRAY

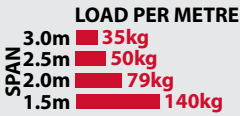

Supplied in 3m lengths.

Width (mm)	Pre-Galvanised		Hot Dip Galvanised	
	Weight (kg)	Part No.	Weight (kg)	Part No.
150	5.1/3m	ET3150G ▲	5.4/3m	ET3150H ▲
300	7.4/3m	ET3300G ▲	7.8/3m	ET3300H ▲
450	9.7/3m	ET3450G ▲	10.3/3m	ET3450H ▲
600	12/3m	ET3600G ▲	12.7/3m	ET3600H ▲

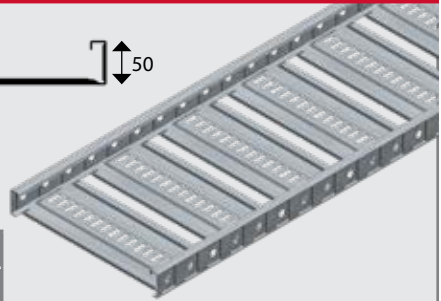

D AVAILABLE IN ALUMINIUM AS MADE TO ORDER (MTO).



ET5 CABLE TRAY

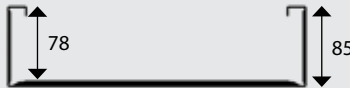
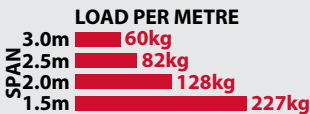

Supplied in 3m lengths.

Width (mm)	Pre-Galvanised		Hot Dip Galvanised	
	Weight (kg)	Part No.	Weight (kg)	Part No.
150	7/3m	ET5150G ▲	6.6/3m	ET5150H ▲
300	8.9/3m	ET5300G ▲	9.4/3m	ET5300H ▲
450	14.2/3m	ET5450G ▲	15/3m	ET5450H ▲
600	17.2/3m	ET5600G ▲	18.2/3m	ET5600H ▲

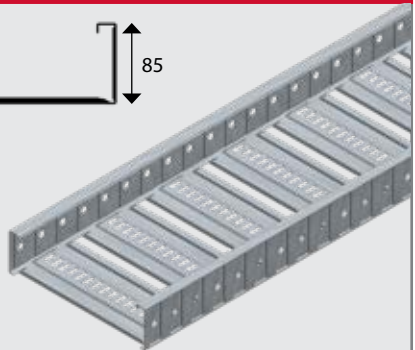

Service Guide Key: ▲ Usually in stock at all branches

■ Normal lead time

■ Usually in stock at head office

■ Made to Order (lead time on enquiry)

HOW TO ORDER ET CABLE TRAY

Example

ET 300 G



Select ET Tray

- ET** ET EzyTray Cable Tray
- ET3** ET3 Cable Tray
- ET5** ET5 Cable Tray

Select Width (mm)

- 150**
- 300**
- 450**
- 600**

Select Finish

- G** Pre-Galvanised
- H** Hot Dip Galvanised
- A** Aluminium*
*(ET3 only)

See pages 50-51 for assembly instructions for ET Cable Tray.

ET3 AND ET5 TRAY IS NOW AVAILABLE AS MADE TO ORDER IN STAINLESS STEEL (S) PLEASE CONTACT EZYSTRUT FOR MORE DETAILS

DS DIVIDER STRIP



S SPLICE

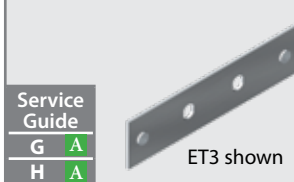

TX TEE/CROSS BRACKET



RL RISER LINK



HD HOLD DOWN

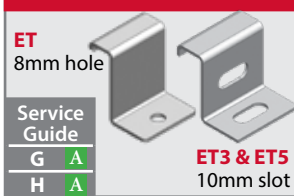

RP RADIUS PLATE

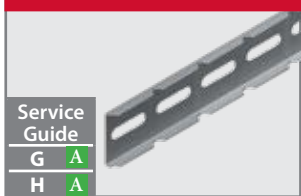

HOW TO ORDER ET CABLE TRAY ACCESSORIES

Example

ET3 S G



Select ET Tray

- ET** ET EzyTray Cable Tray
- ET3** ET3 Cable Tray
- ET5** ET5 Cable Tray

Select Accessory

- S** Splice
- TX** Tee/Cross Bracket
- RL** Riser Link
- HD** Hold Down Unit
- RP** Radius Plate

Select Finish

- G** Pre-Galvanised
- H** Hot Dip Galvanised
- A** Aluminium*
*(ET3 only)

Fasteners required for installation.
Order codes SBH & CNH

FASTENERS

STRUT SYSTEMS

CABLE SUPPORTS

FIRERATED

PIPE SUPPORTS

FASTENERS

STRUT SYSTEMS

CABLE SUPPORTS

FIRERATED

PIPE SUPPORTS

SPLICE

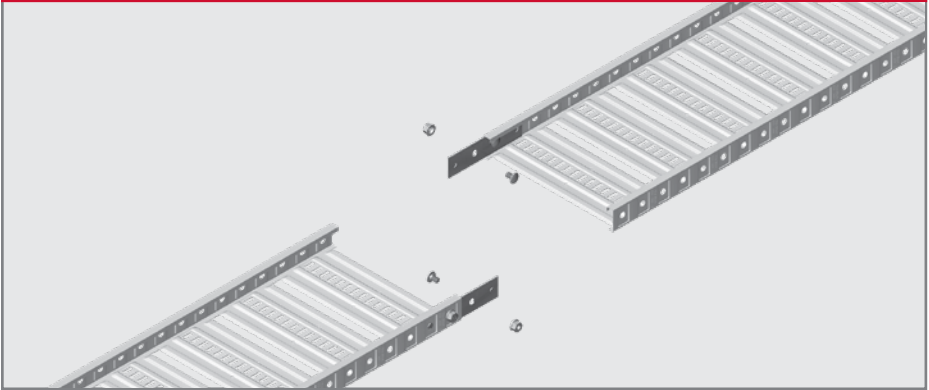

BEND



HOLD DOWN

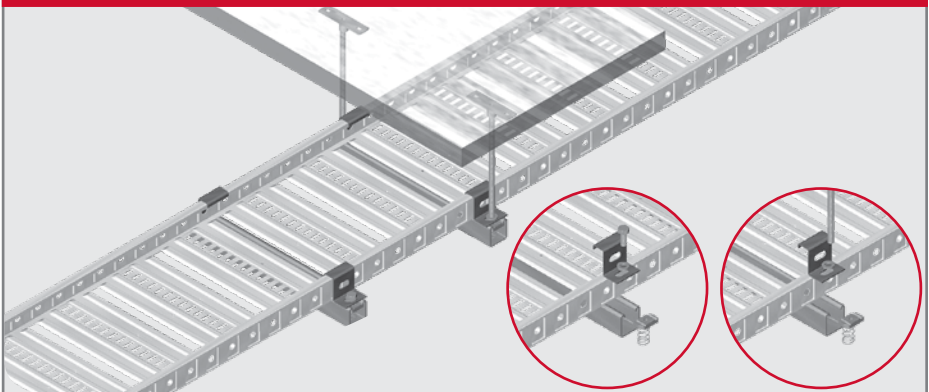

Service Guide Key: **A** Usually in stock at all branches

C Normal lead time

B Usually in stock at head office

D Made to Order (lead time on enquiry)

TEE/CROSS

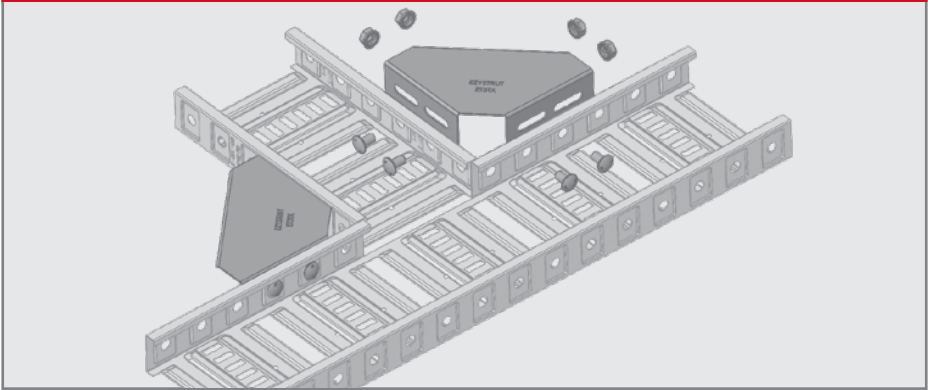

INTERNAL RISER

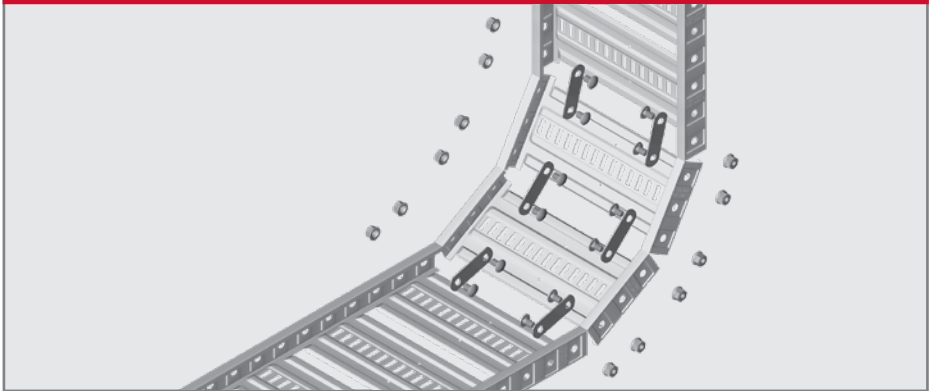

EXTERNAL RISER

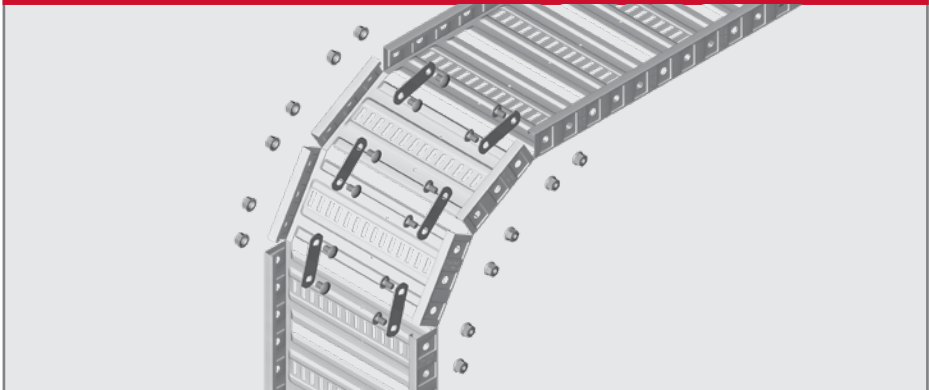

FASTENERS

STRUT SYSTEMS

CABLE SUPPORTS

FIRERATED

PIPE SUPPORTS

CF FLAT COVERS



Supplied in 3m lengths

Cable Tray Flat Covers

Width (mm)	CT or ET Cable Tray		ET3 or ET5 Cable Tray or EzyMesh			
	Pre-Galvanised	Hot Dip Galvanised [†]	Pre-Galvanised		Hot Dip Galvanised [†]	
150	CFCT1503G A	CFCT1503H A	CFET1503G A	CFET1503H A	CFET1503H A	CFET1503H A
300	CFCT3003G A	CFCT3003H A	CFET3003G A	CFET3003H A	CFET3003H A	CFET3003H A
450	CFCT4503G A	CFCT4503H A	CFET4503G A	CFET4503H A	CFET4503H A	CFET4503H A
600	CFCT6003G A	CFCT6003H A	CFET6003G A	CFET6003H A	CFET6003H A	CFET6003H A

Cable Ladder Flat Covers

Width (mm)	Nema 1 Ladder		Nema 2 & Nema 3 Ladder		Nema 2 FRP	
	Pre-Galvanised	Hot Dip Galvanised [†]	Pre-Galvanised	Hot Dip Galvanised [†]	FRP	
150	CFN11503G C	CFN11503H A	CFN21503G A	CFN21503H A	CF150FRP D	CF150FRP D
300	CFN13003G C	CFN13003H A	CFN23003G A	CFN23003H A	CF300FRP D	CF300FRP D
450	CFN14503G C	CFN14503H A	CFN24503G A	CFN24503H A	CF450FRP D	CF450FRP D
600	CFN16003G C	CFN16003H A	CFN26003G A	CFN26003H A	CF600FRP D	CF600FRP D
900	CFN19003G D	CFN19003H D	CFN29003G D	CFN29003H D	CF900FRP D	CF900FRP D

D

NEMA 20C LADDER COVERS ARE AVAILABLE AS MADE TO ORDER (MTO).

Cable Ladder Flat Fitting Covers

SERVICE GUIDE

Standard*
Cable Ladder Fitting Flat Covers are

A OR **B**

Non-Standard
Cable Ladder Fitting Flat Covers are

C OR **D**

*Standard Nema 1 range: widths 150-600mm, 300mm radius and hot dip galvanised finish.

*Standard Nema 2, 3 & 20C range: widths 150-600mm, 450mm radius and hot dip galvanised finish.

Check with your local representative at time of enquiry.
See page 71 for standard sizes and ordering codes.

D **STAINLESS STEEL AND ALUMINIUM FLAT COVERS ARE AVAILABLE AS MADE TO ORDER (MTO).**

*Please note that the process of Hot Dip Galvanising sheet metal products is not recommended and product distortion is likely to occur as a result.

Service Guide Key: **A** Usually in stock at all branches **B** Usually in stock at head office
C Normal lead time **D** Made to Order (lead time on enquiry)

CP PEAKED COVERS

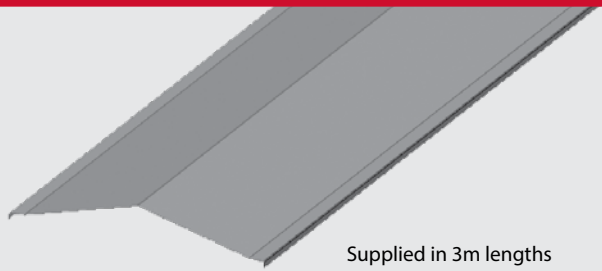
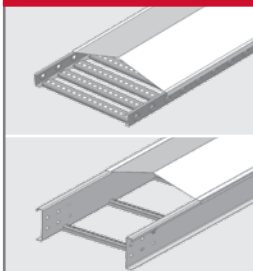

Supplied in 3m lengths

Cable Tray Peaked Covers

Width (mm)	CT or ET Cable Tray		ET3 or ET5 Cable Tray or EzyMesh	
	Pre-Galvanised	Hot Dip Galvanised [~]	Pre-Galvanised	Hot Dip Galvanised [~]
150	CPCT1503G A	CPCT1503H A	CPET1503G C	CPET1503H C
300	CPCT3003G A	CPCT3003H A	CPET3003G C	CPET3003H C
450	CPCT4503G C	CPCT4503H A	CPET4503G C	CPET4503H C
600	CPCT6003G C	CPCT6003H A	CPET6003G C	CPET6003H C

Cable Ladder Peaked Covers

Width (mm)	Nema 1 Ladder		Nema 2 & Nema 3 Ladder	
	Pre-Galvanised	Hot Dip Galvanised [~]	Pre-Galvanised	Hot Dip Galvanised [~]
150	CPN11503G C	CPN11503H C	CPN21503G C	CPN21503H A
300	CPN13003G D	CPN13003H C	CPN23003G C	CPN23003H A
450	CPN14503G D	CPN14503H C	CPN24503G C	CPN24503H A
600	CPN16003G D	CPN16003H C	CPN26003G C	CPN26003H A
900	CPN19003G D	CPN19003H D	CPN29003G D	CPN29003H D

D NEMA 20C LADDER COVERS AND FRP N2 LADDER COVERS ARE AVAILABLE AS MADE TO ORDER (MTO).

Cable Ladder Peaked Fitting Covers

SERVICE GUIDE

Cable Ladder Peaked Fitting Covers are

C OR D

Check with your local representative at time of enquiry.
See page 71 for standard sizes and ordering codes.

D STAINLESS STEEL AND ALUMINIUM PEAKED COVERS ARE AVAILABLE AS MADE TO ORDER (MTO).

[~]Please note that the process of Hot Dip Galvanising sheet metal products is not recommended and product distortion is likely to occur as a result.

VENTED COVERS

CFV FLAT AND VENTED COVERS

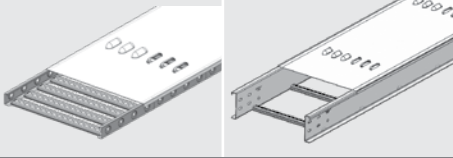

Supplied in 3m lengths

CPV PEAKED AND VENTED COVERS

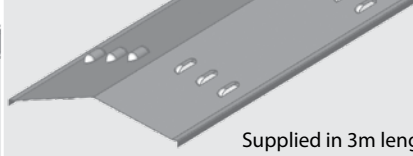
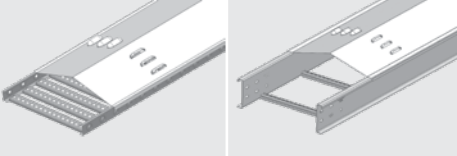

Supplied in 3m lengths

SERVICE GUIDE

Vented Covers for Cable Trays and Cable Ladders are

C OR **D**

Check with your local representative at time of enquiry.
See page 71 for standard sizes and ordering codes.

TOP HAT COVERS

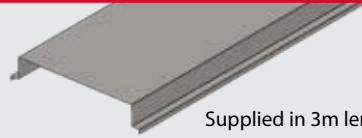
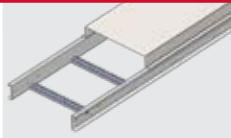
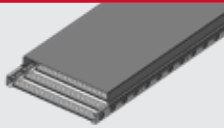

Supplied in 3m lengths

SERVICE GUIDE

Top Hat Covers^^ for Cable Trays and Cable Ladders are

C OR **D**

Check with your local representative at time of enquiry.
See page 71 for standard sizes and ordering codes.

^^Different material thicknesses are available upon request, such as 1.2, 1.6 and 2.0mm.

D

***STAINLESS STEEL AND ALUMINIUM COVERS ARE AVAILABLE AS MADE TO ORDER (MTO).**

^REVERSE RAIL CABLE LADDER COVERS AND FITTINGS, USE CT CABLE TRAY ORDERING CODES

****SEE PAGE 72 & 75 FOR N2 FRP CABLE LADDER COVERS AND FITTING COVERS.**

Service Guide Key:

A

Usually in stock at all branches

B

Usually in stock at head office

C

Normal lead time

D

Made to Order (lead time on enquiry)

FASTENERS

STRUT SYSTEMS

CABLE SUPPORTS

FIRERATED

PIPE SUPPORTS