

HOW TO ORDER CHANNEL

Example

E1000 H



Select Channel

- E1000** 41x41mm/2.5mm THK
- E2000** 41x41mm/1.6mm THK, Ribbed
- E3300** 41x21mm/2.5mm THK
- E4000** 41x21mm/1.6mm THK, Ribbed
- E5500** 41x61mm/2.5mm THK

Select Finish*

- M** Mill Steel
- G** Pre-Galvanised
- H** Hot Dip Galvanised
- S** Stainless Steel
- A** Aluminium
- FRP** Fibre Reinforced Plastic

* Refer to each channel for available finishes and service guide.

E1000 CHANNEL

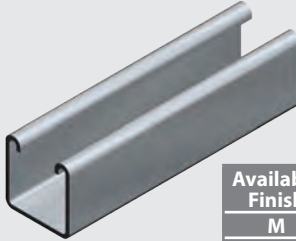
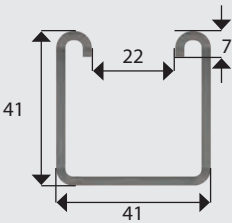

HEAVY DUTY

- Supplied in 6m lengths
- 41x41mm
- 2.5mm THK

Available Finish	Weight	Part Number	Service Guide
M	15.6kg/6m	E1000M	B
G	15kg/6m	E1000G	A
H	16.5kg/6m	E1000H	A
S	16kg/6m	E1000S	A
FRP*	8kg/6m	E1000FRP	B

*See page 72 for more information on FRP Channel/Strut.

MAX LOAD (kg)	1308	654	436	218	109	
SPAN (mm)	0	250	500	750	1500	3000

E2000 RIBBED CHANNEL

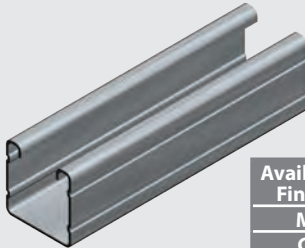
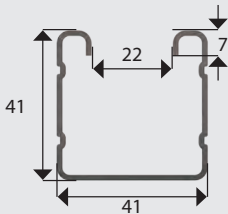

MEDIUM DUTY

- Supplied in 6m lengths
- 41x41mm
- 1.6mm THK

Available Finish	Weight	Part Number	Service Guide
M	10.7kg/6m	E2000M	C
G	10.7kg/6m	E2000G	A
H	11.4kg/6m	E2000H	B
A	3.7kg/6m	E2000A	A

MAX LOAD (kg)	945	471	314	157	78	
SPAN (mm)	0	250	500	750	1500	3000

Service Guide Key: **A** Usually in stock at all branches **B** Usually in stock at head office
C Normal lead time **D** Made to Order (lead time on enquiry)

FASTENERS

STRUT SYSTEMS

CABLE SUPPORTS

FIRERATED

PIPE SUPPORTS

E3300 CHANNEL

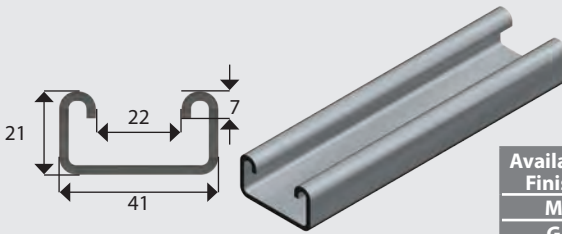

MEDIUM DUTY

- Supplied in 6m lengths
- 41x21mm
- 2.5mm THK

Available Finish	Weight	Part Number	Service Guide
M	11kg/6m	E3300M	B
G	10.7kg/6m	E3300G	A
H	11.7kg/6m	E3300H	A
S	11.8kg/6m	E3300S	A



E4000 RIBBED CHANNEL

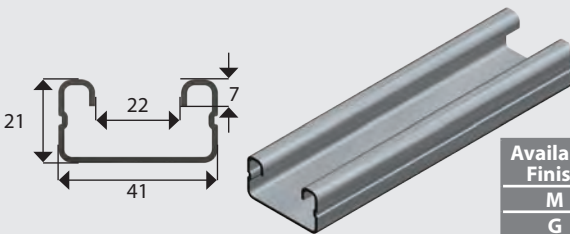

LIGHT DUTY

- Supplied in 6m lengths
- 41x21mm
- 1.6mm THK

Available Finish	Weight	Part Number	Service Guide
M	7.7kg/6m	E4000M	C
G	7.7kg/6m	E4000G	A
H	8.1kg/6m	E4000H	B
A	2.6kg/6m	E4000A	A



E5500 CHANNEL

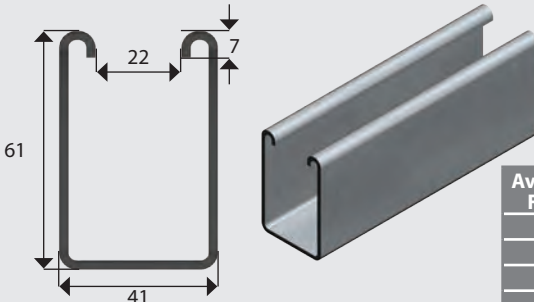

VERY HEAVY DUTY

- Supplied in 6m lengths
- 41x61mm
- 2.5mm THK

Available Finish	Weight	Part Number	Service Guide
M	20.4kg/6m	E5500M	C
G	19.7kg/6m	E5500G	A
H	21.6kg/6m	E5500H	A
S	20.6kg/6m	E5500S	C



FASTENERS

STRUT SYSTEMS

CABLE SUPPORTS

FIRERATED

PIPE SUPPORTS