

STAX^{G4}

STAX50WG4

SAP CODE: 2002322

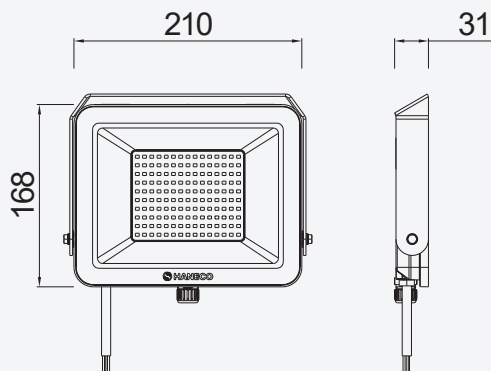

STAX G4 is a versatile and efficient LED Floodlight. With selectable colour temperature, dual power version and optional PIR motion sensor, it is suitable for a wide range of applications.

ACCESSORIES



STAX90D-BRKT-L
SAP CODE: 2002137
90° Bracket - Large



STAX-SENSOR
SAP CODE: 2002135
PIR Sensor



PHOTOMETRIC DIAGRAM

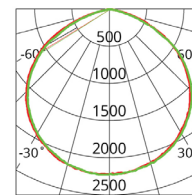

Unit: cd
 - C0/180 115.2deg
 - C90/270 114.6deg

KEY INFORMATION

Power	30/50W
Lumen Output	3670 / 3960 / 3750lm (30W) 5535 / 6280 / 5685lm (50W)
Install	Trunnion Mount
Dimming Options	Non-Dimmable
Fitting Colour	Black (RAL9005)
Warranty	3 years
IP Rating	IP66
IK Rating	IK08
IC Rating	N/A

PHOTOMETRICS

Efficacy	120lm/W @ 4000K
LED	SMD
CCT	3000 / 4000 / 5000K
Beam Angle	120°
CRI	>80
SDCM	<5 @3000K 5000K, <7@4000K
Useful life @Ta25° (L70)	50,000hr

ELECTRICAL

Driver	Integral (DOB)
Supply Input	220-240Va.c. 50/60Hz
Driver Output Voltage	270Vd.c.
Power Factor	>0.95

CONSTRUCTION

Housing Material	Aluminum
Diffuser Material	Glass (Clear)
Adjustable Angle	0-360°
Fixings/Hardware	Mounting bracket
Connection Type	0.6M, Flex
Total Weight	1.10kg
Dimensions	210x168x31mm
Operating Ambient Temp.	-20 to 45°C
Electrical Classification	Class 1