

TITAN X

Corrosion Proof LED Battens



TITAN X



Corrosion Proof LED Battens

Product information

The next generation of Titan fittings, the Titan X, has been designed to be even tougher and pack in more features than before. Standard features include: 3 colour selection, multiple power settings, giant terminal blocks, marine grade external hardware, multiple side and rear entry points, and a wide mounting footprint. Sensor models feature 0-10V dimmable drivers with the sensor being tuneable for sensitivity, time, luminance, and a variety of holding patterns. Our innovative Yellow / Green version can switch between yellow or green by the user with an internal switch. Emergency version available on the standard, sensor, and yellow/green models. DALI drivers available as an accessory kit. All of this packed inside an IK10 IP65 housing with 316 stainless steel clips and backed by our 5 year warranty (1 year for EM batteries).



TECHNICAL INFORMATION STANDARD MODELS

	ML-TN60-X-M	ML-TN60-X-M-EM	ML-TN60-X-M-SN	ML-TN60-X-M-SE	ML-TN120-X-M	ML-TN120-X-M-EM	ML-TN120-X-M-SN	ML-TN120-X-M-SE
Total Power:	MAX 20W*	MAX 23W*	MAX 20W*		MAX 40W*	MAX 43W*	MAX 40W*	
Power selection :	11W/14W/ 17W/20W	13W/16W/ 20W/23W	16W/20W		20W/27W/ 34W/40W	23W/30W/ 37W/43W	25W/40W	
MAX Lumen Output:	WW 2215lm NW 2530lm W 2430lm	WW 2000lm NW 2200lm W 2100lm	WW 2114lm NW 2274lm W 2120lm		WW 4515lm NW 4800lm W 4600lm	WW 4515lm NW 4900lm W 4730lm	WW 4200lm NW 4800lm W 4400lm	WW 4000lm NW 4600lm W 4200lm
Colour Temp:	WW 3000K NW 4000K W 6500K				WW 3000K NW 4000K W 6500K			
IP Rating:	IP65				IP65			
Efficacy:	WW 110 lm/w NW 125 lm/w W 121lm/w	WW 86 lm/w NW 95 lm/w W 91lm/w	WW 100 lm/w NW 110 lm/w W 105 lm/w	WW 105 lm/w NW 113 lm/w W 106 lm/w	WW 112 lm/w NW 120 lm/w W 115 lm/w	WW 105 lm/w NW 114 lm/w W 110 lm/w	WW 105 lm/w NW 120 lm/w W 110 lm/w	WW 100 lm/w NW 115 lm/w W 105 lm/w
CRI:	80				80			
Beam Angle:	120°				120°			
Temp Range:	-20° to +50°C	0° to +50°C	-20° to +50°C	0° to +50°C	-20° to +50°C	0° to +50°C	-20° to +50°C	0° to +50°C
Dimmable:	NO		YES (1 - 10V)		NO		YES (1 - 10V)	
Power Supply:	Osram driver, 220-240V AC 50/60Hz		Boke driver , 220 - 240V AC 50/60Hz		Osram driver, 220-240V AC 50/60Hz		Boke driver , 220 - 240V AC 50/60Hz	
Average Life:	50,000 hrs**				50,000 hrs**			
Input / Inrush	0 . 085/35A	0 . 096/35A	0 . 09/3 . 25A	0 . 1/3 . 25A	0 . 17/50A	0 . 18/50A	0 . 17/3 . 3A	0 . 18A/3 . 3A
Power Factor :	>0.9				>0.9			
IK Rating	IK10				IK10			
Dimensions:	655*130*88mm				1265*130*88mm			
Weight:	1.1KG	1.3KG	1.2KG	1.4KG	1.9KG	2.2KG	2.1KG	2.3KG
Warranty:	5 years (1 year for EM batteries)				5 years (1 year for EM batteries)			

TITAN X 60

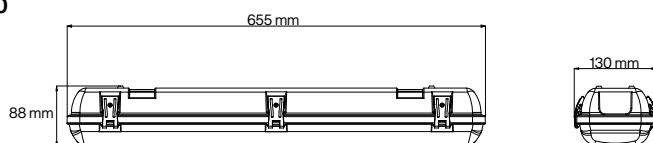

TITAN X 120

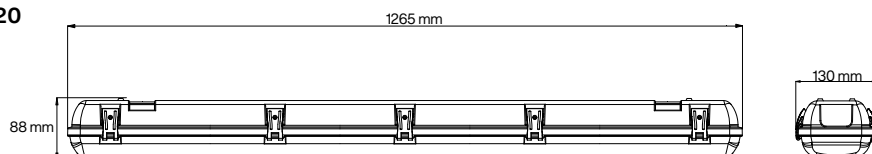

*Total power consumed including driver

** Average life is calculated on expected average lifespan, Emergency and Sensor Model 30,000 hrs

TECHNICAL INFORMATION YELLOW AND GREEN MODELS

	ML-TN60-X-YG	ML-TN60-X-YG-EM	ML-TN60-X-YG-SN	ML-TN60-X-YG-SE	ML-TN120-X-YG	ML-TN120-X-YG-EM	ML-TN120-X-YG-SN	ML-TN120-X-YG-SE
Total Power:	MAX 20W*	MAX 23W*	MAX 20W*		MAX 40W*	MAX 43W*	MAX 40W*	
Power selection :	11W/14W/ 17W/20W	13W/16W/ 20W/23W	16W/20W		20W/27W/ 34W/40W	23W/30W/ 37W/43W	25W/40W	
MAX Lumen Output:	G 1743lm Y 1683lm				G 3590lm Y 3476lm			
IP Rating:	IP65				IP65			
Efficacy:	G 94lm/w Y 91lm/w				G 83lm/w Y 80lm/w			
Beam Angle:	120°				120°			
Temp Range:	-20° to +50°C	0° to +50°C	-20° to +50°C	0° to +50°C	-20° to +50°C	0° to +50°C	-20° to +50°C	0° to +50°C
Dimmable:	NO		YES (1 - 10V)		NO		YES (1 - 10V)	
Power Supply:	Osram driver, 220-240V AC 50/60Hz		Boke driver , 220 - 240V DC 50/60Hz		Osram driver, 220-240V AC 50/60Hz		Boke driver , 220 - 240V DC 50/60Hz	
Average Life:	50,000 hrs**				50,000 hrs**			
Input / Inrush	0 . 085/35A	0 . 096/35A	0 . 09/3 . 25A	0 . 1/3 . 25A	0 . 17/50A	0 . 18/50A	0 . 17/3 . 3A	0 . 18/3 . 3A
Power Factor :	>0.9				>0.9			
IK Rating	IK10				IK10			
Dimensions:	655*130*88mm				1265*130*88mm			
Weight:	1.1KG	1.3KG	1.2KG	1.4KG	1.9KG	2.2KG	2.1KG	2.3KG
Warranty:	5 years (1 year for EM batteries)				5 years (1 year for EM batteries)			

*Total power consumed including driver

** Average life is calculated on expected average lifespan, Emergency and Sensor Model 30,000 hrs

TECHNICAL INFORMATION DALI MODELS

	AVAILABLE TO ORDER (OPTIONAL DALI DRIVER)	
	ML-TN60-X-DALI	ML-TN120-X-DALI
Total Power:	32W*	44W*
Power selection :	POWER SELECTABLE UP TO 36.2W***	POWER SELECTABLE UP TO 49.5W***
IP Rating:	IP20	
CRI:	80+	
Beam Angle:	120°	
Temp Range:	-20° to +40°C	
Dimmable:	0/1-10V DALI Dimming	
Power Supply:	Boke DALI driver , 220 - 240V DC 50/60Hz	
Average Life:	50,000 hrs**	
Input / Inrush	0.75/11A	1 . 1/11A
Power Factor :	>0.9	
Dimensions:	245*30*21mm	285*30*21mm
Weight:	0.170KG	0.239KG
Warranty:	5 YEARS	

*Total power consumed including driver

** Average life is calculated on expected average lifespan, Emergency and Sensor Model 30,000 hrs

*** Comprehensive output current list is found on the power selection charts

TECHNICAL INFORMATION EMERGENCY CLASSIFICATIONS

ML-TN60-X-M-SE	
C0	D50
C90	D40

ML-TN120-X-M-SE	
C0	D63
C90	D40

ML-TN120-X-M-EM	
C0	D50
C90	D32

ML-TN120-X-YG-SE	
C0	D50
C90	D32

TITAN X Battens

PLEASE NOTE!

MUST BE INSTALLED BY LICENSED ELECTRICIAN

Do not extend low voltage cables from the output of the power supply.

All components must not be mechanically stressed.

- Be careful not to damage or destroy conducting paths on the circuit board.
- Follow all relevant electrical and safety standards (Including AS3000) – only qualified personnel should be allowed to perform installations.

- Damage by corrosion will not be honored as a material defect claim. It is the user's responsibility to provide suitable protection against corrosive agents such as moisture, condensation and other harmful elements.
- If these regulations are not followed warranty will be void and all issues are the responsibility of the installer.

For further information please visit www.melec.com.au

WIRING DIAGRAM

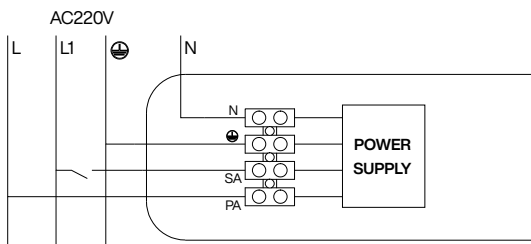

L: Emergency power (Permanent Active)
Must be connected for EM to operate

L1: Switched / Light input (switched active), loop with L for permanently on. Must be on same phase as L

If this fitting has an EM module installed it will require 24hrs for the battery to fully charge. This fitting will run for up to 3 hrs at 3W of power if emergency mode is engaged.

INSTALLATION INSTRUCTIONS

1. Turn power off before commencing installation.
2. Always use suitable fixings for your type of installation.
3. Fix TITAN directly through the back of the unit but be sure to seal all penetrations to prevent water ingress, install the fixing clamp on the location where the TITAN is to be installed (surface mounted or suspended).
4. When running cables into the fitting ensure you use a suitable sealant to prevent any future water penetration.

5. Wire TITAN according to the labels on the terminal.
6. Install gear tray onto internal clips.
7. Install cover onto base and ensure there is an even seal and install security screws to latches.
8. Test and commission.

Suggested installation height (for sensor models):
Wall installation: 1-2m

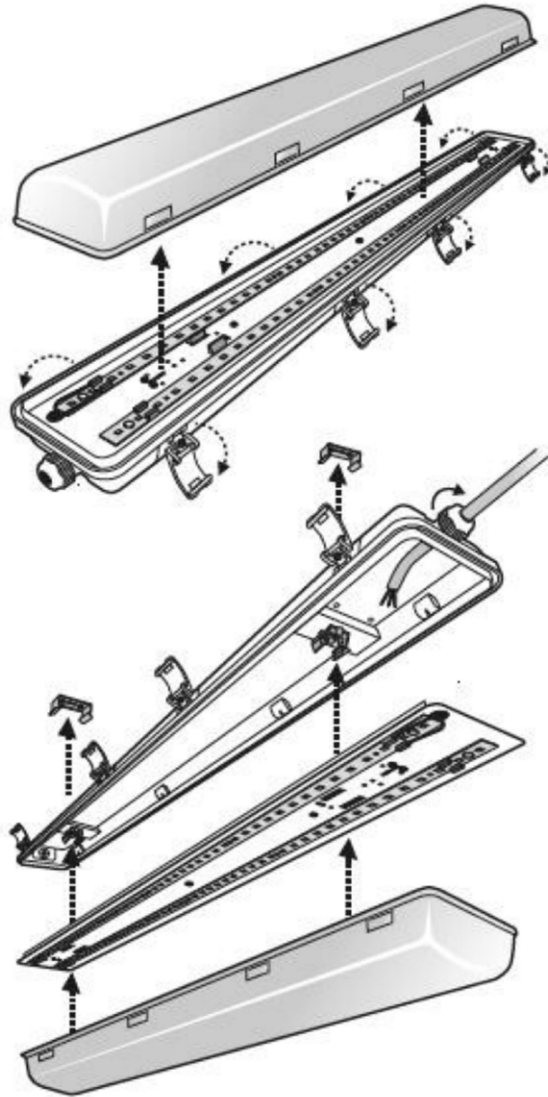
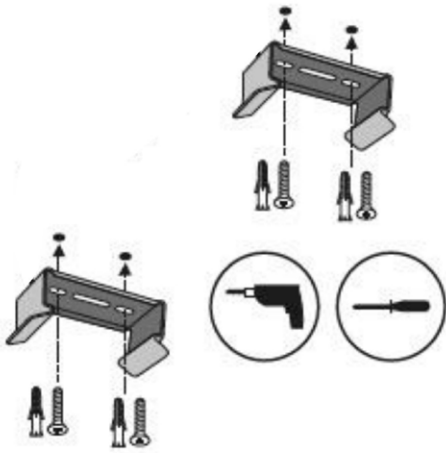

SURFACE MOUNT

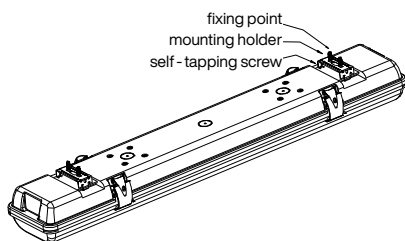
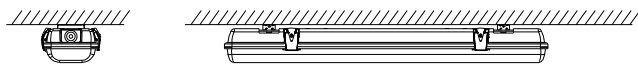

SUSPENDED

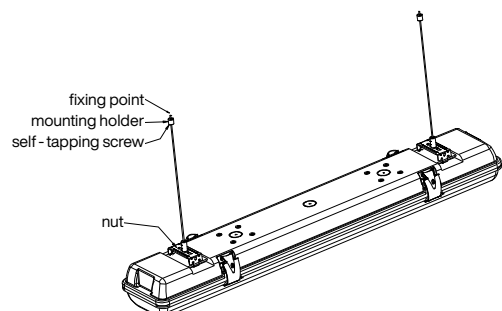
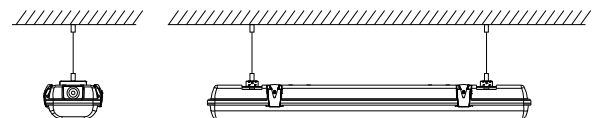

MICROWAVE SENSOR



SPECIFICATIONS

Power source: 12V DC
 Transmission power: <math><0.2\text{mW}</math>
 HF system: 5.8GHz \pm 75MHz
 Detection angle: 360°
 Detection range: \varnothing 4 - 10m
 Installation: Indoors | Ceiling | Mounting height 2.5 - 4m
 Working temperature: -20°C to +60°C
 Stand - by power: Approx 0.5W

Time setting: 5 Sec \pm 3 Sec
 30 Sec \pm 10 Sec
 1 Min \pm 30 Sec
 10 Min \pm 1 Min (ADJUSTABLE)
 Light Control: 2 Lux | 10 Lux
 50 Lux | DISABLED (ADJUSTABLE)
 Stand - by period : 0 Sec | 30 Sec
 20 Min | ∞
 Sytand - by dimming level : 10% | 20% | 30% | 50% (ADJUSTABLE)

SENSOR INFORMATION

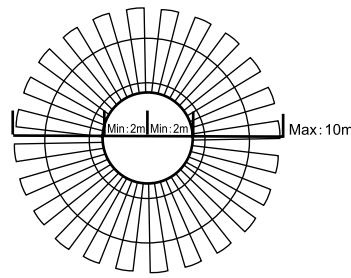
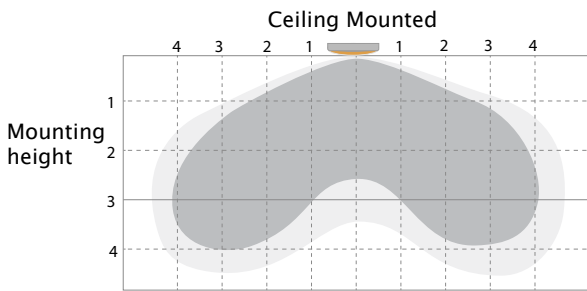

Height of Installation 2.5m
 Detection range

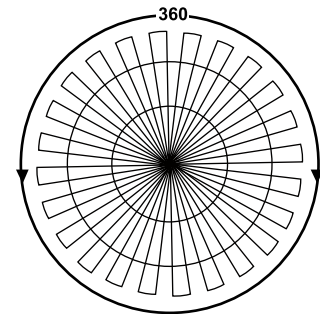

Detection angle

PARAMETER SETTING

There are 4 adjustments available to this sensor:

1. Sensitivity for the detection range of the sensor (S1).
2. On time of the light (S2 + S3).
3. Light level settings (S4 + S5).
4. Stand-by period (S6 + S7)
5. Stand-by dimming level (S8 + S9)

When WHITE DOT is listed on the instructions below it means the dip switch is OFF (down toward the number).
 When BLACK DOT is listed it means the dip switch is ON (up toward ON).



● Switch UP
 ○ Switch DOWN

PLEASE NOTE!

The high - frequency output of this sensor is <math><0.2\text{mW}</math>- that is just one 5000th of the transmission power of a mobile phone or the output of a microwave oven.

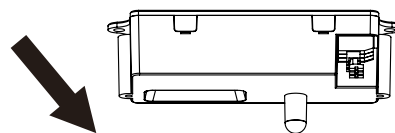

Transmission power <math><0.2\text{mW}</math>

DETECTION RANGE (SENSITIVITY)

Detection range is the term used to describe the detection zone produced on the ground after mounting the sensor light. This range listed below is given as a guide and assumes the mounting height is 2.5m from ground level.

S1	Detection range
●	5m
○	10m

When using this product please adjust the sensitivity to an appropriate position you need. The following may prevent the motion detection from working normally: blowing leaves, curtains, small animals or even power grid & electrical equipment. If this should happen, simply try to lower the sensitivity appropriately and then test it.

LIGHT LEVEL SETTINGS (LUX)

Lux settings can be adjusted so that the sensor will only operate the light when minimum light settings are reached. Alternatively you can set the sensor to 'DISABLE' allowing the sensor to operate continuously.

Adjust the dip switches according to the desired time settings shown in the chart below:

S4	S5	LUX
●	●	DISABLE
●	○	50 LUX
○	●	10 LUX
○	○	2 LUX

STAND - BY DIMMING LEVEL

Dim level can be adjusted during standby period.

Adjust the dip switches according to the desired dim level settings shown in the chart below:

S8	S9	DIM LEVEL
●	●	10 %
●	○	20 %
○	●	30%
○	○	50%

TIME SETTING (ON TIME)

The light can be set to stay ON for periods of time between 5 seconds to 10 minutes. Any movements detected before this time elapses will result in the timer being restarted. Adjust the dip switches according to the desired time settings shown in the chart below.

PLEASE NOTE!

After the light switches OFF it takes approximately 4 sec before it is able to start detecting movement again.

The light will only switch ON in response to movement detected once this period has elapsed.

S2	S3	Time
●	●	5 sec
●	○	30 sec
○	●	1 min
○	○	10 min

STAND - BY PERIOD

Stand - by period is a time setting , that keeps the light at preset dimmed level before switching it completely off . Setting it to ∞ , the light will be dimmed to a preset dimming level indefinitely (or until movement is detected) .

S6	S7	TIME
●	●	0 sec
●	○	30 sec
○	●	20 min
○	○	∞



WARNING The following installation situation will lead to nuisance operation!

1. Being installed unevenly or prone to movement (such as loose suspension in a windy area).
2. Moving objects such as curtains.
3. Frequent traffic (people, cars or other objects).
4. Sparks or moving electrical equipment.

EMERGENCY VERSION

PLEASE READ INSTRUCTIONS BEFORE COMMENCING INSTALLATION AND RETAIN FOR FUTURE REFERENCE.

TESTING

The emergency lighting must be inspected and tested regularly in accordance with regulations and laws. We suggest the following as a minimum.

PLEASE NOTE!

After initial installation please allow 24 hours to ensure the battery is fully charged before commencing tests.

1. Daily check that charge indicator LED is working.
2. Monthly, interrupt mains for a short period and check LED lights.
3. Annual 12 month check, full duration test (longer than 2 hours). Batteries or the fitting should be replaced if they fail to last the 2 hours.
4. Complete record sheet on installation and retain in maintenance file.
5. Update file with ongoing test records for inspection by fire officer or other duly authorised person.

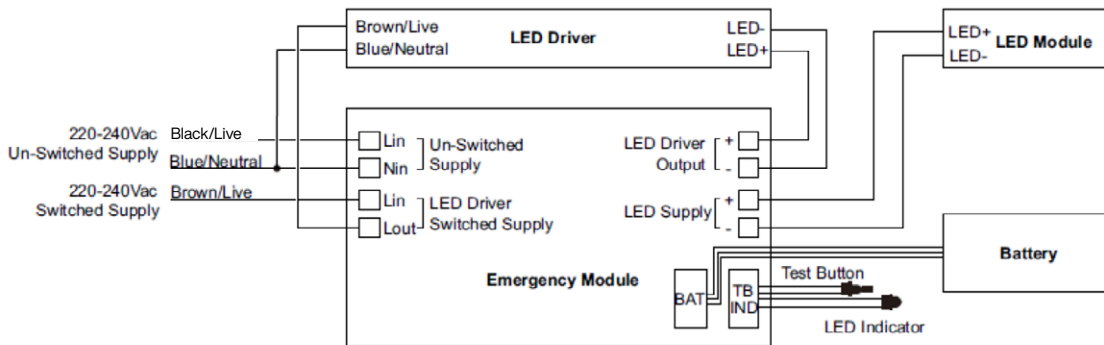

PLEASE NOTE!

- Take note of the requirement to dispose of Waste Electrical & Electronic Equipment separately from household waste (WEEE marked with a crossed out wheelie bin symbol).
- Product technical information and specification may change over time without prior notification. For the latest technical information please visit our web site www.melec.com.au

POWER SELECTION

Default 25W:

200mAh

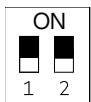

Switch 1=OFF
Switch 2=OFF

250mAh

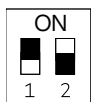

Switch 1=OFF
Switch 2=ON

300mAh

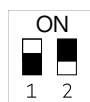

Switch 1=ON
Switch 2=OFF

350mAh

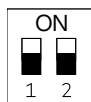

Switch 1=ON
Switch 2=ON

OUTPUT CURRENT	MAX POWER
200 mA	10 W
250 mA	13 W
300 mA	16 W
350 mA	19 W

Default 45W:

200mAh



Switch 1=OFF
Switch 2=OFF

250mAh



Switch 1=OFF
Switch 2=ON

300mAh



Switch 1=ON
Switch 2=OFF

350mAh



Switch 1=ON
Switch 2=ON

OUTPUT CURRENT	MAX POWER
200 mA	24 W
250 mA	30 W
300 mA	36 W
350 mA	42 W

POWER SELECTION - SENSOR MODELS

Sensor 30W:

350mAh



Switch 1=OFF
Switch 2 =ON
Switch 3=ON
Switch 4 =ON

400mAh



Switch 1=ON
Switch 2=OFF
Switch 3=ON
Switch 4 =ON

450mAh



Switch 1=OFF
Switch 2 =OFF
Switch 3=ON
Switch 4 =ON

500mAh

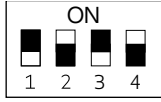

Switch 1=OFF
Switch 2 =ON
Switch 3=OFF
Switch 4 =ON

550mAh



Switch 1=OFF
Switch 2=OFF
Switch 3=OFF
Switch 4 =ON

600mAh

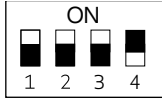

Switch 1=ON
Switch 2 =ON
Switch 3=ON
Switch 4 =OFF

650mAh



Switch 1=OFF
Switch 2=OFF
Switch 3=ON
Switch 4 =OFF

700mAh



Switch 1=OFF
Switch 2=ON
Switch 3=OFF
Switch 4 =OFF

750mAh

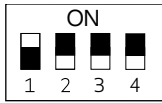

Switch 1=ON
Switch 2 =OFF
Switch 3=OFF
Switch 4 =OFF

800mAh

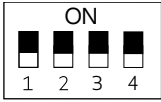

Switch 1=OFF
Switch 2 =OFF
Switch 3=OFF
Switch 4 =OFF

OUTPUT CURRENT	MAX POWER
350 mA	15W
400 mA	17W
450 mA	19W
500 mA	21W
550 mA	23W
600 mA	25W
650 mA	27W
700 mA	29W
750 mA	30W
800 mA	31W

Sensor 40W:

600mAh

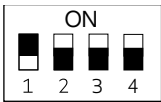

Switch 1=OFF
Switch 2 =ON
Switch 3=ON
Switch 4 =ON

650mAh

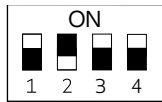

Switch 1=ON
Switch 2=OFF
Switch 3=ON
Switch 4 =ON

700mAh



Switch 1=OFF
Switch 2 =OFF
Switch 3=ON
Switch 4 =ON

750mAh

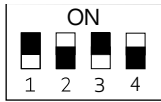

Switch 1=OFF
Switch 2 =ON
Switch 3=OFF
Switch 4 =ON

800mAh

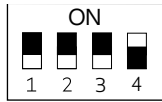

Switch 1=OFF
Switch 2=OFF
Switch 3=OFF
Switch 4 =ON

850mAh

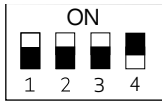

Switch 1=ON
Switch 2 =ON
Switch 3=ON
Switch 4 =OFF

900mAh



Switch 1=OFF
Switch 2 =OFF
Switch 3=ON
Switch 4 =OFF

950mAh



Switch 1=OFF
Switch 2=ON
Switch 3=OFF
Switch 4 =OFF

1000mAh

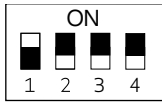

Switch 1=ON
Switch 2 =OFF
Switch 3=OFF
Switch 4 =OFF

1050mAh

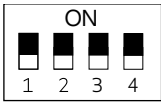

Switch 1=OFF
Switch 2 =OFF
Switch 3=OFF
Switch 4 =OFF

OUTPUT CURRENT	MAX POWER
600 mA	25W
650 mA	27W
700 mA	29W
750 mA	32W
800 mA	34W
850 mA	36W
900 mA	38W
950 mA	40W
1000 mA	40W
1050 mA	40W

POWER SELECTION - DALI MODELS

DALI 30W:

200mA

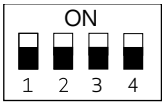

Switch 1=ON
Switch 2=ON
Switch 3=ON
Switch 4=ON

225mA



Switch 1=OFF
Switch 2=ON
Switch 3=ON
Switch 4=ON

250mA

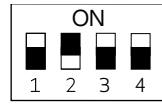

Switch 1=ON
Switch 2=OFF
Switch 3=ON
Switch 4=ON

275mA

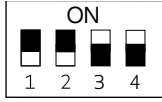

Switch 1=OFF
Switch 2=OFF
Switch 3=ON
Switch 4=ON

300mA

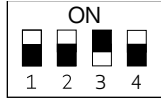

Switch 1=ON
Switch 2=ON
Switch 3=OFF
Switch 4=ON

325mA

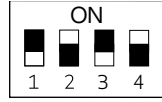

Switch 1=OFF
Switch 2=ON
Switch 3=OFF
Switch 4=ON

350mA

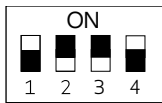

Switch 1=ON
Switch 2=OFF
Switch 3=OFF
Switch 4=ON

375mA

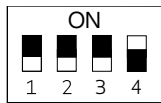

Switch 1=OFF
Switch 2=OFF
Switch 3=OFF
Switch 4=ON

400mA



Switch 1=ON
Switch 2=ON
Switch 3=ON
Switch 4=OFF

450mA

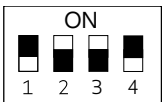

Switch 1=OFF
Switch 2=ON
Switch 3=ON
Switch 4=OFF

500mA

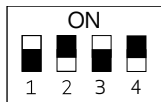

Switch 1=ON
Switch 2=OFF
Switch 3=ON
Switch 4=OFF

550mA

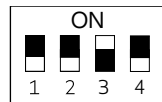

Switch 1=OFF
Switch 2=OFF
Switch 3=ON
Switch 4=OFF

600mA

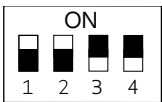

Switch 1=ON
Switch 2=ON
Switch 3=OFF
Switch 4=OFF

650mA

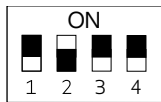

Switch 1=OFF
Switch 2=ON
Switch 3=OFF
Switch 4=OFF

700mA



Switch 1=ON
Switch 2=OFF
Switch 3=OFF
Switch 4=OFF

750mA

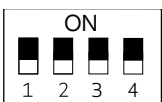

Switch 1=OFF
Switch 2=OFF
Switch 3=OFF
Switch 4=OFF

OUTPUT CURRENT	MAX POWER
200 mA	12.8W
225 mA	14.3W
250 mA	15.9W
275 mA	17.3W
300 mA	18.7W
325 mA	20.3W
350 mA	21.7W
375 mA	23.3W
400 mA	24.8W
450 mA	27.9W
500 mA	31.0W
550 mA	34.1W
600 mA	35.9W
650 mA	35.9W
700 mA	36.2W
750 mA	36.2W

DALI 40W:

350mAh

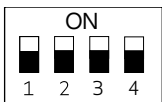

Switch 1=ON
Switch 2=ON
Switch 3=ON
Switch 4=ON

400mAh

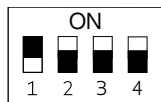

Switch 1=OFF
Switch 2=ON
Switch 3=ON
Switch 4=ON

450mAh

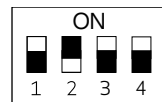

Switch 1=ON
Switch 2=OFF
Switch 3=ON
Switch 4=ON

500mAh

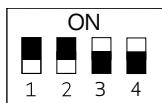

Switch 1=OFF
Switch 2=OFF
Switch 3=ON
Switch 4=ON

550mAh

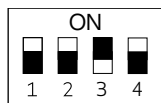

Switch 1=ON
Switch 2=ON
Switch 3=OFF
Switch 4=ON

600mAh

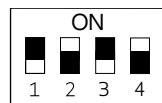

Switch 1=OFF
Switch 2=ON
Switch 3=OFF
Switch 4=ON

650mAh

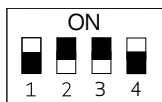

Switch 1=ON
Switch 2=OFF
Switch 3=OFF
Switch 4=ON

700mAh

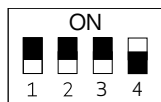

Switch 1=OFF
Switch 2=OFF
Switch 3=OFF
Switch 4=ON

750mAh

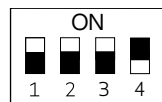

Switch 1=ON
Switch 2=ON
Switch 3=ON
Switch 4=OFF

OUTPUT CURRENT	MAX POWER
350 mA	21.5W
400 mA	24.5W
450 mA	27.5W
500 mA	30.5W
550 mA	33.5W
600 mA	36.5W
650 mA	39.5W
700 mA	42.5W
750 mA	45.5W
800 mA	48.5W
850 mA	49.5W
900 mA	49.5W
950 mA	49.5W
1000 mA	49.5W
1050 mA	49.5W
1100 mA	49.5W

POWER SELECTION - DALI MODELS

800mAh

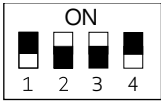

Switch 1=OFF
Switch 2=ON
Switch 3=ON
Switch 4=OFF

850mAh

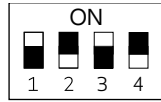

Switch 1=ON
Switch 2=OFF
Switch 3=OFF
Switch 4=OFF

900mA

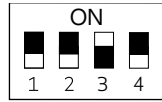

Switch 1=OFF
Switch 2=OFF
Switch 3=ON
Switch 4=OFF

950mA



Switch 1=OFF
Switch 2=OFF
Switch 3=ON
Switch 4=ON

1000mA

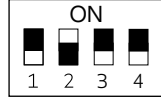

Switch 1=OFF
Switch 2=ON
Switch 3=OFF
Switch 4=OFF

1050mA



Switch 1=ON
Switch 2=OFF
Switch 3=OFF
Switch 4=OFF

1100mA



Switch 1=OFF
Switch 2=OFF
Switch 3=OFF
Switch 4=OFF

DIMMING CONNECTIONS (APPLICABLE ONLY TO SENSOR MODELS)

1 - 10V/10V PWM dimming application

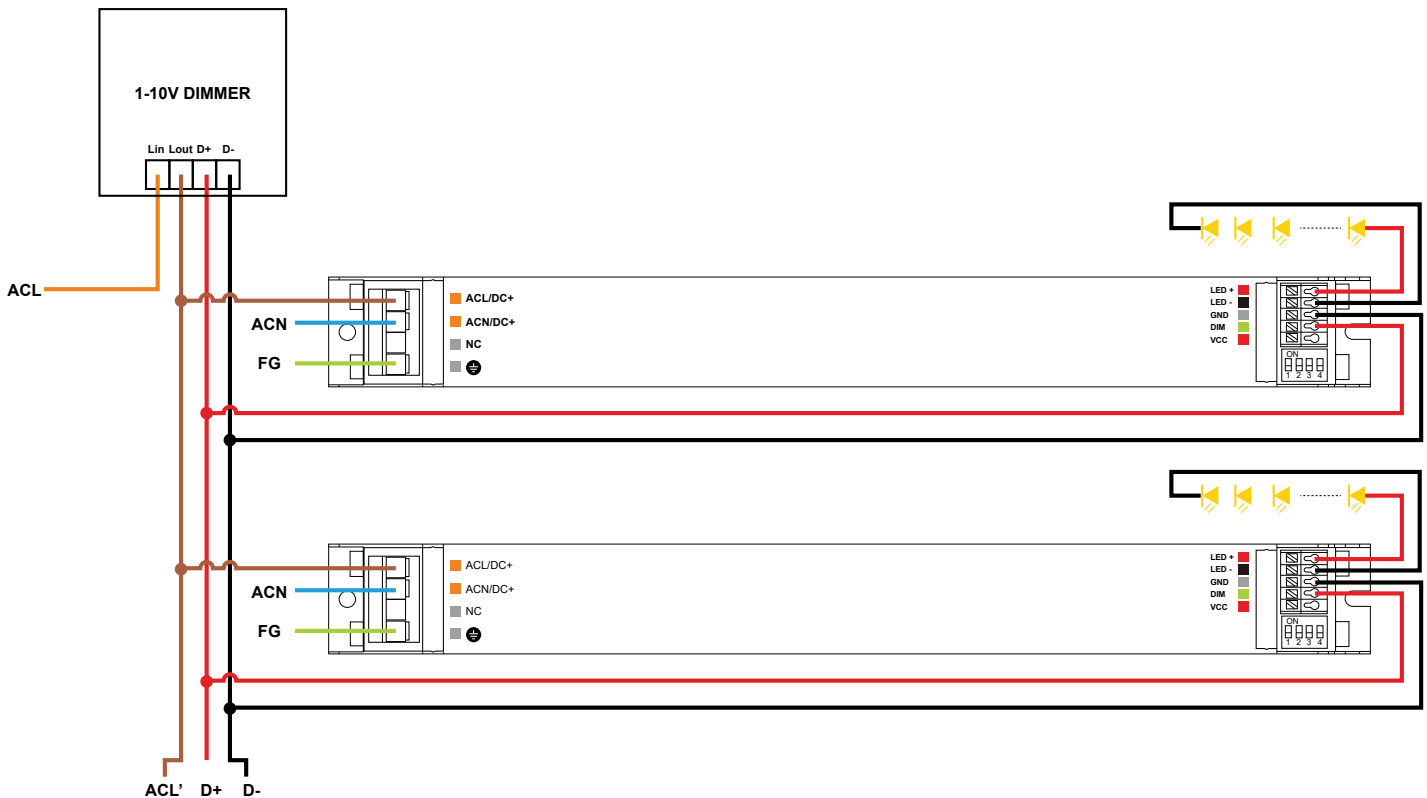

NOTES:

- Dimming interface characteristics : 0 . 9V and below are closed , 1V is the darkest , 10V is the brightest , 1 - 10V is the dimming range .
- The dimming interface distinguishes between positive and negative , DIM is positive , GND is negative , please do not reverse .
- Dimming interface does not support voltage higher than 15V , otherwise it will damage internal components .
- When the dimming interface is open , the driver outputs the maximum current . When the interface is short - circuited , the current output is closed .
- When multiple synchronous dimming is required , the positive poles of the dimming interface of each driver are connected together , and the negative poles are connected together .
- Supports passive dimmer or isolated active dimmer . Dimming does not support non - isolated active dimmer dimming .
- It is recommended that the dimming wires should not be lower than 22AWG wire
- Do not connect the dimming wires alongside high voltage or interference sources . If it is unavoidable , please use shielded wires .

POWER SELECTION - DALI MODELS

DALI dimming application

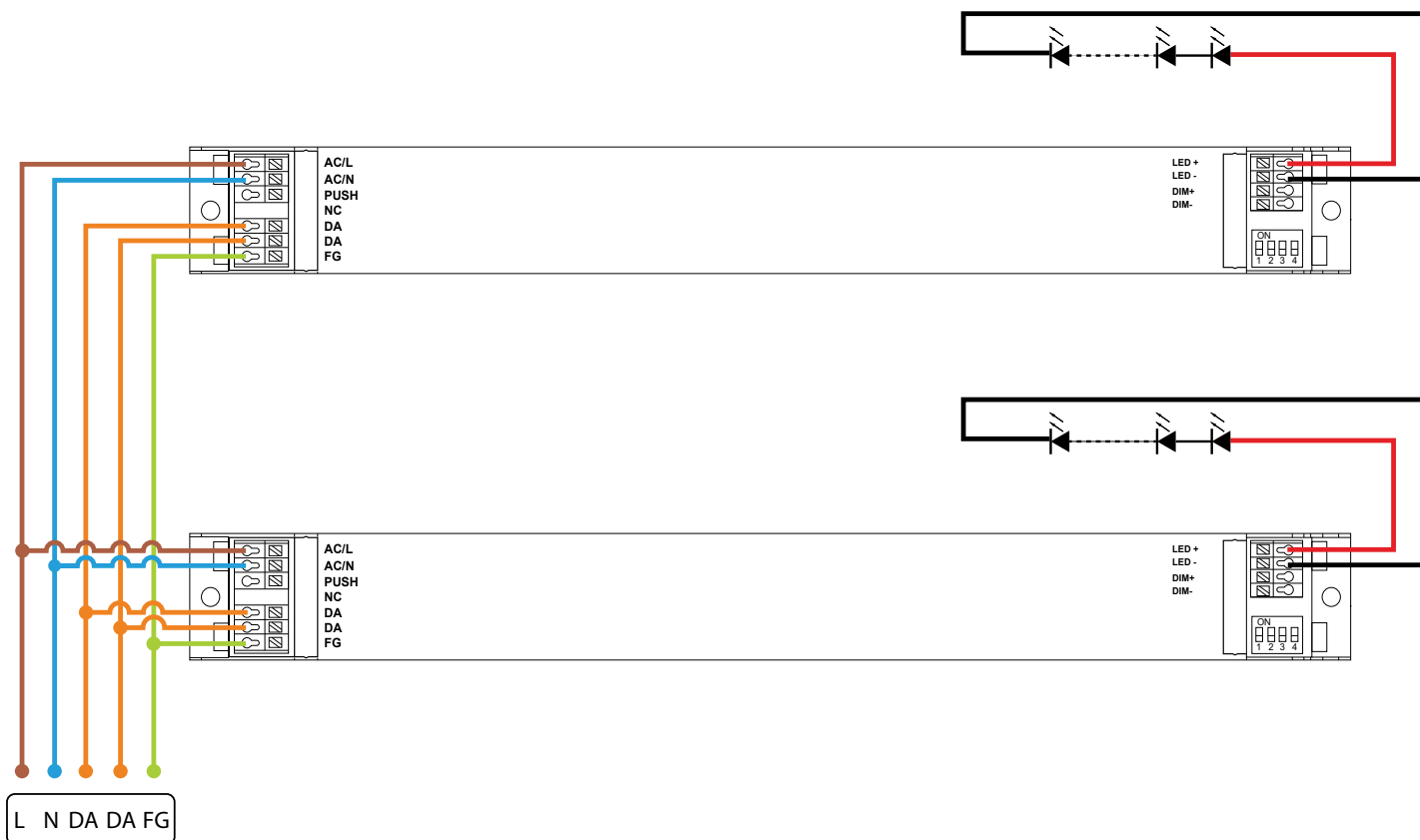

NOTES :

Activating DALI dimming mode :

- After installation according to the above wiring diagram the driver will automatically switch to the DALI control mode after receiving any DALI command .

Remarks :

- Standard DALI control line voltage range : 9 . 5V to 22 . 5V , type 16V .
- The two DALI control lines polarity - reversible .
- Max . 64 DALI driver per DALI control line .
- The maximum distance length of the DALI control line is 300m at 2 x 1 . 5mm² .
- The DALI bus can be wired together with any mains voltage cables , but separate wiring is recommended .
- The configuration parameters of the driver can be set through the DALI configuration tool or DALI application controller during installation , such as setting device address , group address , power - on level , bus - failure level , scene level , fade time , dimming curve , etc .

Power - on level :

When the driver is in DALI - 2 dimming mode , the factory default level after each power - on is the brightest .

The power - on level can be set through the DALI configuration tool or DALI application controller during installation , and can be set to memory or fixed any brightness (such as off , darkest , 50% , etc .) .

Note : The recommended setting for the default factory power - on level of the DALI - 2 driver is the brightest in the DALI - 2 standard .

FREE
ONSITE WARRANTY

EXCLUSIVE TO
MEMBERS ONLY



FREE ONSITE WARRANTY FOR 3 YEARS
INCLUDES PARTS & LABOUR

In conjunction with your standard product warranty