

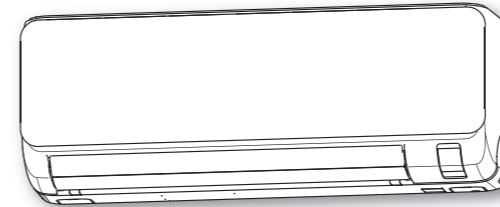

# USER'S MANUAL

## AIR-CONDITIONER



DXK05ZTLA-WF  
DXK07ZTLA-WF  
DXK09ZTLA-WF  
DXK12ZTLA-WF  
DXK18ZTLA-WF



**MITSUBISHI HEAVY INDUSTRIES THERMAL SYSTEMS, LTD.**  
2-3, Marunouchi 3-chome, Chiyoda-ku, Tokyo, 100-8332, Japan  
<https://www.mhi-mth.co.jp/en/>

**MITSUBISHI HEAVY INDUSTRIES AIR-CONDITIONERS AUSTRALIA, PTY. LTD.**  
Block E, 391 Park Road, Regents Park, NSW, 2143 PO BOX 3167, Regents Park, NSW, 2143  
Tel : +61-2-8774-7500  
Fax: +61-2-8774-7501  
<https://www.mhial.com.au/>

RLH012A004A  
202304

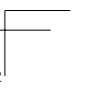
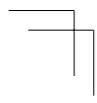
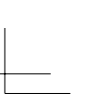
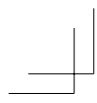

Thank you for purchasing a MITSUBISHI HEAVY INDUSTRIES THERMAL SYSTEMS, LTD. Air-Conditioner. To get the best long-lasting performance, please read and follow this user's manual carefully before using your air-conditioner. After reading, please store the manual in a safe place and refer to it for operational questions or in the event of any irregularities.



Your air-conditioner is marked with this symbol. It means that waste electrical and electronic equipment (WEEE as in directive 2012/19/EU) should not be mixed with general household waste. Air-conditioner should be treated at an authorized treatment facility for re-use, recycling and recovery and not be disposed of in the municipal waste stream. Please contact the installer or local authority for more information.



This symbol printed on the batteries attached to your air-conditioner is information for end-users according to the EU directive 2006/66/EC article 20 annex II. Batteries, at their end-of-life, should be disposed of separately from general household waste. If a chemical symbol is printed beneath the symbol shown above, this chemical symbol means that the batteries contain a heavy metal at a certain concentration. This will be indicated as follows: Hg:mercury(0.0005 %), Cd:cadmium(0.002 %), Pb:lead(0.004 %)  
Please, dispose of batteries correctly at your local community waste collection or the recycling center.



The emission sound pressure level from each Indoor and Outdoor unit is under 70 dB(A).

## contents

<p>Safety precautions.....2</p> <p>Tips for effective operation .....7</p> <p>Name of each part and its function.....8</p> <p>Remote control .....10</p> <p>Operation failure with the remote control.....10</p> <p>Temporary run operation .....10</p> <p>Installing two air-conditioners in the same room.....11</p> <p>Child lock .....11</p> <p>Airflow range setting .....12</p> <p>Operation and display section for remote control .....13</p> <p>Current time setting .....14</p> <p>AUTO mode operation.....14</p> <p>Temperature adjustment during AUTO mode ...15</p> <p>FAN SPEED .....15</p> <p>COOL/HEAT/DRY/FAN mode operation.....16</p> <p>Air-conditioner operation temperature range ....16</p> <p>Characteristics of HEAT mode operation.....16</p> <p>Airflow direction adjustment.....17</p> <p>3D AUTO operation .....17</p> <p>SLEEP TIMER operation .....18</p> <p>OFF TIMER operation.....18</p> <p>ON TIMER operation .....19</p>	<p>SLEEP TIMER + ON TIMER operation.....19</p> <p>PROGRAM TIMER operation .....20</p> <p>ALLERGEN CLEAR operation .....20</p> <p>HIGH POWER/ECONOMY operation.....21</p> <p>NIGHT SETBACK operation.....22</p> <p>SILENT operation .....22</p> <p>MENU function</p> <p>Wireless LAN connection setting .....23</p> <p>Backlight setting.....23</p> <p>Display brightness adjustment.....24</p> <p>SELF CLEAN operation .....24</p> <p>Fan control in heating thermo - OFF.....25</p> <p>SILENT mode setting.....26</p> <p>Wireless LAN communication setting .....26</p> <p>Initialization of wireless LAN setting .....27</p> <p>PRESET operation .....28</p> <p>Maintenance .....29</p> <p>Proper installation.....31</p> <p>Troubleshooting .....31</p> <p>Notice .....31</p> <p>Contact your dealer .....33</p> <p>Auto restart function .....33</p> <p>Self diagnosis function.....34</p> <p>DRED .....35</p>
--	--







# Safety precautions

- Before starting to use the system, please read these “Safety precautions” carefully to ensure proper operation of the system.
- When you have read this user’s manual, please keep it safely. If someone else takes over as user, make sure that the manual is also passed on to the new user.

 <b>WARNING</b>	Indicates a potentially hazardous situation which, if not avoided, can result in serious consequences such as death or severe injury.
 <b>CAUTION</b>	Indicates a potentially hazardous situation which, if not avoided, can result in personal injury or property damage.

Please observe these precautions with great care, since they are essential to your safety.

- Symbols which appear frequently in the text have the following meaning:

	<b>Strictly prohibited</b>		<b>Observe instructions with great care</b>		<b>Provide proper earthing</b>
	<b>The user’s manual should be read carefully.</b>		<b>A service personnel should be handing this equipment with reference to the installation manual.</b>		
	<b>There is information included in the user’s manual and/or installation manual.</b>				

## ■ Following precaution is for R32.

	<b>This equipment uses flammable refrigerants. If the refrigerant is leaked, together with an external ignition source, there is a possibility of ignition.</b>
---	---

 <b>WARNING</b>	
<ul style="list-style-type: none"> <li>• Strict compliance of the domestic laws must be observed when disposing the appliance.</li> <li>• Do not use means to accelerate the defrosting process or to clean, other than those recommended by the manufacturer.</li> <li>• The appliance shall be stored in a room without continuously operating ignition sources (for example: open flames, an operating gas appliance or an operating electric heater).</li> <li>• Do not pierce or burn.</li> <li>• Be aware that refrigerants may not contain an odour.</li> </ul>	<ul style="list-style-type: none"> <li>• The appliance shall be stored in a well-ventilated area where the room size corresponds to the room area as specified for operation.</li> <li>• The staff in servicing operations must hold the national qualification or other relevant qualifications.</li> <li>• The indoor unit shall be stored in a room that has a minimum area of 4.0 m<sup>2</sup>.*</li> <li>*This value is for split system. In the case of multi system, see the installation sheet of outdoor unit.</li> </ul>

## ■ Safety precautions

### ■ INSTALLATION PRECAUTIONS

#### ⚠ WARNING



- **The system is for domestic and residential use.**

If used in severe environments, such as an engineering workplace, the equipment may function poorly.



- **The system must be installed by your dealer or a qualified installer.**

It is not advisable to install the system by yourself, as faulty handling may cause leakage of water, electric shock or fire.

#### ⚠ CAUTION



- **Do not install it where flammable gas may leak.**

Gas leaks may cause fire.



- **Make sure that an earth leakage breaker is installed.**

If you do not install an earth leakage breaker, you may get an electric shock.

- **Make sure to install the drain hose properly so that all the water is drained out.**

Improper installation may lead to water drop in the room resulting in wet furniture.



- **Make sure that the system has been properly earthed.**

Earth wire should never be connected to a gas pipe, water pipe, lightning conductor or telephone earth wire. Improper installation of the earth wire may cause an electric shock.



This Product contains fluorinated greenhouse gases.

- Do not vent R32 into the atmosphere: R32 is a fluorinated greenhouse gas with a Global Warming Potential (GWP) = 675.

Refer to a label on outdoor unit for the weight of fluorinated greenhouse gas and CO<sub>2</sub> equivalent.

## ■ Safety precautions

### ■ OPERATION PRECAUTIONS

<b>⚠ WARNING</b>	
	<ul style="list-style-type: none"><li>• <b>Children shall not play with the air-conditioner.</b></li><li>• <b>Do not expose yourself to the cooling air for a long period.</b> This could affect your physical condition and cause health problems.</li></ul> <ul style="list-style-type: none"><li>• <b>Cleaning and user maintenance shall not be made by children without supervision.</b></li><li>• <b>Do not insert anything into the air outlet.</b> This may cause injury, as the internal fan rotates at high speed.</li></ul>
	<ul style="list-style-type: none"><li>• <b>This air-conditioner can be used by children aged from 8 years and above and people with reduced physical, sensory or mental capabilities or lack of experience and knowledge, if they have been given supervision or instruction concerning use of the air-conditioner in a safe way and understand the hazards involved.</b></li><li>• <b>Store the remote control out of reach of children.</b> Failure to observe this may result in the batteries being swallowed or other accidents.</li></ul>

<b>⚠ CAUTION</b>	
	<ul style="list-style-type: none"><li>• <b>Only use approved fuses.</b> Use of steel or copper wire instead of an approved fuse is strictly prohibited, as it may cause a breakdown or fire.</li><li>• <b>Do not handle the switches with wet hands.</b> This may cause an electric shock.</li><li>• <b>Do not swing from the indoor unit.</b> If the indoor unit falls down, you may get injured.</li><li>• <b>Do not place a flammable insecticide or paint spray near the air-conditioner, nor spray it directly on the system.</b> This may result in a fire.</li><li>• <b>Do not expose any combustion appliance directly to the air stream of the air-conditioner.</b> The combustion appliance may malfunction.</li><li>• <b>Do not wash the air-conditioner with water.</b> This could cause an electric shock. Using a high pressure washer may cause damage to the aluminum fins, resulting in performance decrement.</li></ul> <ul style="list-style-type: none"><li>• <b>Do not use for preservation of food, plants or animals, precision devices or works of art.</b> The system is only intended for use in ordinary domestic rooms. Any other use of the system may damage the quality of food, etc.</li><li>• <b>Do not place anything containing water, like vases, on top of the unit.</b> Water entering the unit could damage the insulation and therefore cause an electric shock.</li><li>• <b>Do not install the air-conditioner where the airflow direction is aimed directly at plants or animals.</b> This will damage their health.</li><li>• <b>Do not step/sit on the unit nor put anything on it.</b> If the unit falls down or things drop from it, people could get hurt.</li><li>• <b>After a long period of use, check the unit's support structure regularly.</b> If you do not repair any damage right away, the unit may fall down and cause personal injury.</li></ul>

## ■ Safety precautions

<b>⚠ CAUTION</b>	
	<ul style="list-style-type: none"> <li>• <b>Do not touch the aluminum fins on the heat exchanger.</b> It may result in injury.</li> <li>• <b>Do not place household electrical appliances or household items underneath the indoor or outdoor units.</b> Condensation falling from the unit may stain objects and cause accidents or electrical shock.</li> <li>• <b>Do not operate the system without the air filter.</b> It can cause malfunction of the system due to clogging of the heat exchanger.</li> </ul>
	<ul style="list-style-type: none"> <li>• <b>Do not shut off the power source immediately after stopping the operation.</b> Wait at least 5 minutes, otherwise there is a risk of water leakage or breakdown.</li> <li>• <b>Do not control the system with main power switch.</b> It can cause fire or water leakage. In addition, the fan can start unexpectedly, which can cause personal injury.</li> <li>• <b>Do not pour liquid into the unit and do not put water container on the unit.</b> Water entering the unit could damage the insulation and therefore cause an electric shock.</li> </ul>
	<ul style="list-style-type: none"> <li>• <b>If you operate air-conditioner together with a combustion appliance, you must regularly ventilate the indoor air.</b> Insufficient ventilation may cause accidents due to oxygen deficiency.</li> <li>• <b>Stand firmly on a stepladder or other stable object when removing the inlet panel and filters.</b> Failure to observe this may result in injury through insecure objects toppling over.</li> <li>• <b>When you clean air-conditioner, stop the unit and turn off the power source.</b> Never open the panel while the internal fan is rotating.</li> <li>• <b>Do not place objects near the outdoor unit or allow leaves to gather around the unit.</b> If there are objects or leaves around the outdoor unit, small animals may enter unit and contact electrical parts and may cause a break-down, smoke or fire.</li> </ul>
	<ul style="list-style-type: none"> <li>• <b>Contact your dealer to clean inside the indoor unit, do not attempt to do by yourself.</b> The use of a non-approved detergent or improper washing method may damage the unit's plastic components and cause leaks. Damage, smoke, or fire may also happen if the detergent comes in contact with electrical parts or the unit's motor.</li> <li>• <b>Stop the unit and turn off the power if you hear thunder or there is a danger of lightning.</b> It may damage the unit.</li> <li>• <b>If the power cable becomes damaged, contact your dealer or a qualified installer.</b> If it is not replaced, it may cause a breakdown or fire.</li> </ul>

## ■ Safety precautions

### ■ WIRELESS LAN PRECAUTIONS

#### WARNING



- **Do not turn ON the wireless LAN communication near automatic control equipment such as an automatic door or fire-alarm device.**  
It may cause an accident due to malfunction of equipment.
- **Do not turn ON the wireless LAN communication in a hospital, etc. where the use of wireless devices is prohibited.**  
It may cause malfunction of medical equipment due to a wireless device.
- **Do not turn ON the wireless LAN communication near a person with a cardiac pacemaker or implanted defibrillator.**  
It may cause malfunction of a medical device.

#### CAUTION



- **Do not turn ON the wireless LAN communication near another wireless device, microwave, cordless phone, fax machine, etc.**  
It may cause malfunction of wireless device.
- **When operating the air-conditioner from outdoors, fully confirm the statuses of the unit, its periphery, and persons in the room beforehand.**  
It may cause damage to your health, contamination of household goods, or negative effects on animals.
- **When someone is in the room, notify him/her that the air-conditioner is to be operated from outdoor.**  
It may cause damage to your health.





- **Check the operational status periodically.**  
Sudden indoor/outdoor temperature changes may cause damage to your health.



## ■ Safety precautions

### ■ PRECAUTIONS FOR RELOCATION OR REPAIRS

<b>⚠ WARNING</b>	
	<ul style="list-style-type: none"><li>• <b>Do not perform any repairs or modifications by yourself. Consult the dealer if the unit requires repair.</b> If you repair or modify the unit, it can cause water leaks, electric shocks or fire.</li></ul>
	<ul style="list-style-type: none"><li>• <b>Consult your dealer for repairs.</b> Wrong repairs could cause an electric shock, fire, etc.</li><li>• <b>In case the air-conditioner is relocated elsewhere, contact your dealer or a qualified installer.</b> Faulty installation may cause water leakage, electric shock, fire, etc.</li><li>• <b>If you notice anything abnormal (smell of burning, etc.), stop the system, turn off the power source and consult your dealer.</b> Continued use of the system in abnormal circumstances can result in malfunctioning, electric shock, fire, etc.</li><li>• <b>If the air-conditioner fails to cool or warm the room, it may have a refrigerant leakage. Contact your dealer.</b> <b>If refrigerant needs to be added, check with your dealer for proper instructions.</b> If the refrigerant comes in contact with the bare skin, it may cause cold injury. If the refrigerant gas is inhaled excessively, it may cause deterioration of nerve function like dizziness and headache, or deterioration of heart function like irregular heartbeat and heart palpitation temporarily. If refrigerant unexpectedly leaks from the unit onto a fan heater, stove, hotplate or other heat source, harmful gases could be generated.</li></ul>

## Tips for effective operation

■ Please observe the following for the most economic and comfortable use of your unit.

- **Set a suitable room temperature.**  
Excessively high or low temperatures are not good for your health and waste of electricity.
- **Clean the filters frequently.**  
Clogged filters may block the airflow and cause less efficient operation.  Page 29
- **Avoid direct sunlight and draught.**  
Cut out direct sunlight by drawing the curtains or blinds when cooling. Keep windows and doors shut, except when ventilating.
- **Adjust the airflow direction properly.**  
Adjust the up/down and left/right airflow to ensure a steady room temperature.
- **Operate the unit only when needed.**  
Use the timer properly to operate the unit only when needed.
- **Keep heat source away when cooling.**  
Keep heat sources out of the room as much as possible.

# Name of each part and its function

## INDOOR UNIT

**Air inlet panel**  
 ➔ Page 29

**Air filters**  
 ➔ Page 29

**Fan**  
 • Inside of the unit

**Heat exchanger (Aluminum fin)**

**Louvers (Vertical blades)**  
 • Left / right airflow direction adjustment

**Flaps (Horizontal blades)**  
 • Up / down airflow direction adjustment

**Air inlet**

**QR code**  
 • You can check the SSID and KEY (Password).

**Air-cleaning filter**

➔ Page 30

- Allergen clear filter (Light orange)

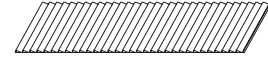

- This equipment uses flammable refrigerant.

➔ Page 2

### ! WARNING

Do not wash the inside of the air conditioner. Water leakage and permanent damage may result. Electrical hazard exists.

Caution, high voltage, shut off power before servicing fan and fan motor.

By the following operation, forced cooling operation is possible. Isolate the power supply. Reconnect power supply. Hold the ON/OFF switch down for 5 seconds until hear a beep.



**Model name**

**Air outlet**

**Room temperature sensor**

**Unit display section**

➔ Page 9

## OUTDOOR UNIT

**Air inlet (back and side)**

**Fan**  
 • Inside of the unit

**Heat exchanger (Aluminum fin)**

**Air outlet**

**Drain hole**



**MOVING FAN BLADES**  
 DO NOT INSERT ANYTHING INTO THE AIR OUTLET. IT MIGHT CAUSE INJURY.



**SHARP EDGE OF FINS**  
 DO NOT TOUCH THE ALUMINUM FINS. IT MIGHT CAUSE INJURY.



**DO NOT STEP ON TOP OF THIS UNIT.**  
 IT MIGHT CAUSE INJURY.

**Model name and refrigerant type**

**Refrigerant pipe and electric wire**

**Drain hose**



- This equipment uses flammable refrigerant.

➔ Page 2

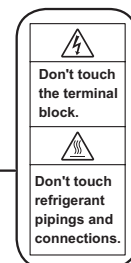

\* The appearance varies by models

# Name of each part and its function

## Unit display section

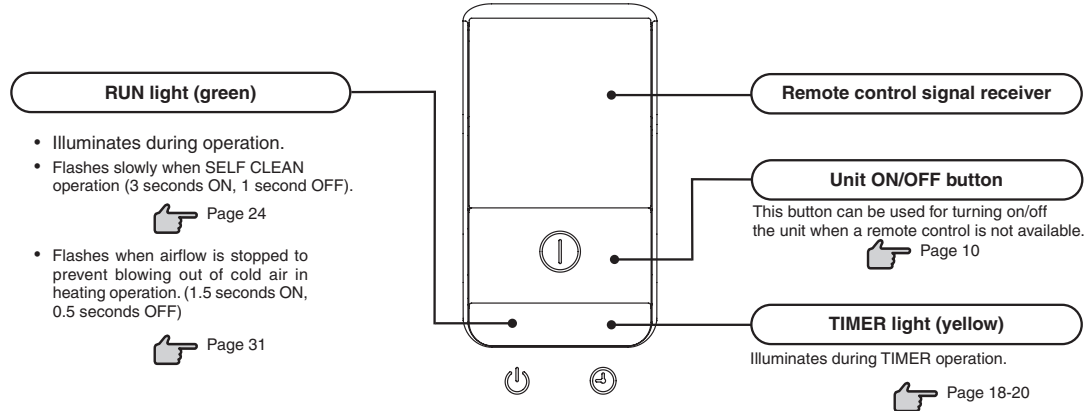

## Accessories

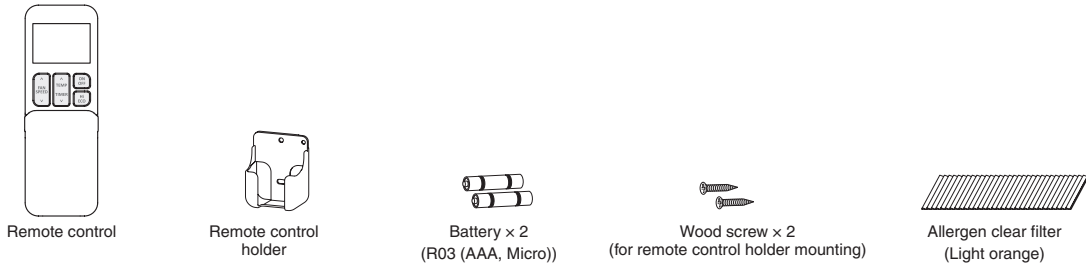

### NOTICE

#### • Buzzer sound for remote control

**Buzzer sound (PipPip) is emitted when** preset temperature is set to 24 °C or, AUTO operation mode is selected or, automatic airflow is selected (except DRY and FAN mode operation).

**Buzzer sound (Pip) is emitted when** air-conditioner is turned off by pressing ON/OFF button (except SELF CLEAN operation).

**Buzzer sound (Peep Pip) is emitted when** Wireless LAN connection setting, Wireless LAN communication setting.

#### Airflow setting

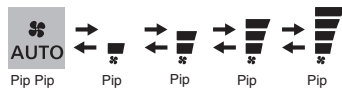

#### Preset temperature



#### • Backlight for remote control

Press the button of the remote control lights the backlight.  
The backlight turns off automatically if there is no operation for certain period of time.  
The backlight can be turned on/off. page 23

# Remote control

## Setting the batteries

**1** Remove the cover.

**2** Insert new batteries.  
R03 (AAA, Micro) × 2 or  
LR03 (AAA, Micro) × 2

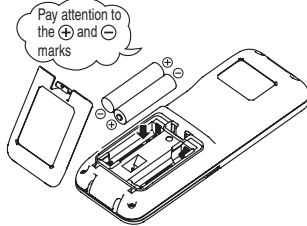

**3** Close the cover.

**4** Press the ACL switch with the tip of a ballpoint pen.

Set the current time.

Page 14 Current time setting Step 2

### NOTICE

- Do not mix old and new batteries, or batteries of different types (manganese/alkaline).
- Alkaline batteries are recommended.
- Remove the batteries when the remote control is not used for a long period.
- The recommended effective period of a battery conforming to JIS or IEC should be 6 to 12 months with normal use. If used longer, or when an unspecified battery is used, liquid may leak from the battery, causing the remote control to malfunction.
- The recommendable effective period is printed on the battery. This may be shorter due to manufacturing time to the unit. However, the battery may still be in working order after expiry of its nominal life.

- When the display shows any abnormal condition, press the ACL switch with the tip of a ballpoint pen.

## Using the remote control holder

The remote control can be attached to a wall or pillar by using the remote control holder. Before installing the remote control, check that the air-conditioner receives the signals properly.

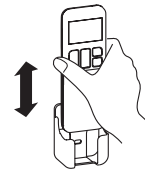

For installing or removing the remote control, move it up or down in the holder.

The following cases show exhausted batteries. Replace old batteries with new ones.

- Receiving beep is not emitted when a signal is transmitted.
- Display fades away.

## Warning note for remote control

### ⊘ Strictly prohibited

- |   |  |  |
|---|--|--|
| <ul style="list-style-type: none"> <li>• Do not take remote control near high temperature places, such as an electric heating carpet or a stove.</li> </ul> | <ul style="list-style-type: none"> <li>• Do not leave the remote control exposed to direct sunlight or other strong lighting.</li> </ul> | <ul style="list-style-type: none"> <li>• Do not drop the remote control. Handle with care.</li> </ul>                |
| <ul style="list-style-type: none"> <li>• Do not put any obstructing obstacles between the remote control and the unit.</li> </ul>                           | <ul style="list-style-type: none"> <li>• Do not spill any liquid on the remote control.</li> </ul>                                       | <ul style="list-style-type: none"> <li>• Do not place heavy objects on the remote control, or step on it.</li> </ul> |

# Operation failure with the remote control

• Are the batteries running down?

"Setting the batteries" above.

Replace the batteries with new ones and retry the operation.

• If the operation fails, operate the unit with temporary run operation function.

"Temporary run operation" below.

Contact your dealer to have the remote control checked.

# Temporary run operation

• The unit ON/OFF button on the unit operates ON/OFF temporarily when the remote control is not used.

### Operation program

- OPERATION MODE : AUTO
- FAN SPEED : AUTO
- AIRFLOW : AUTO

• Operation starts by pressing the unit ON/OFF button; it stops if you press the button again.

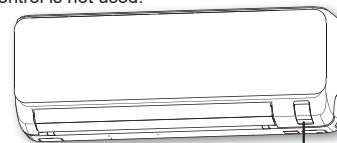

Unit ON/OFF button

### NOTICE

- Do not keep pressing the unit ON/OFF button down for 5 seconds or more. (Pressing it 5 seconds or more sets the forced cooling operation used during servicing or when relocating the air-conditioner.)

# Installing two air-conditioners in the same room

- When two air-conditioners are installed in the same room, use this setting when the two air-conditioners are not operated with one remote control. Set the remote control and indoor unit.

## Setting the remote control

**1** Remove the cover and take out batteries.

**2** Disconnect the switching line next to the battery with wire cutters.

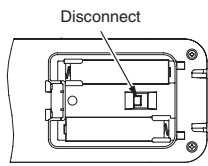

**3** Insert batteries. Close the cover.

## Setting an indoor unit

**1** Turn off the power source and turn it on after 1 minute.

**2** Point the remote control (that was set according to the procedure described on the left side) at the indoor unit and send a signal by pressing the ACL switch on the remote control.

Since the signal is sent in about 6 seconds after the ACL switch is pressed, point the remote control at the indoor unit for some time.

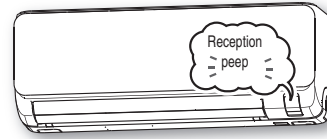

**3** Check that the reception buzzer sound “peep” is emitted from the indoor unit.

At completion of the setting, the indoor unit emits a buzzer sound “peep”. (If no reception sound is emitted, start the setting from the beginning again.)

# Child lock

- This function locks the remote control operation to prevent an operation error.

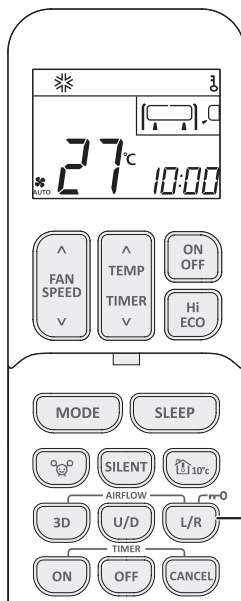

**1** Press the AIRFLOW L/R (LEFT/RIGHT) button for 3 seconds or more.

$\mathfrak{L}$  is displayed. When Child lock is set, only the ON/OFF button can be operated.

### How to cancel

Turn off the light  $\mathfrak{L}$  by pressing the AIRFLOW L/R (LEFT/RIGHT) button for 3 seconds or more.

### NOTICE

- While Child lock is set, the settings of operation mode, temperature, fan speed and airflow direction cannot be changed. To change the settings, reset Child lock.

# Airflow range setting

- Take the air-conditioner location into account and adjust the left/right airflow range to maximize air-conditioning.

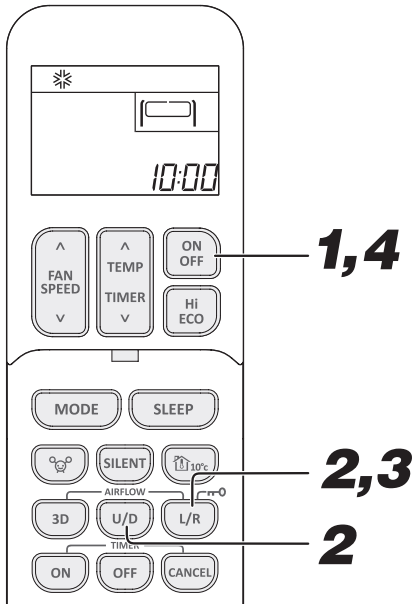

**1** If the air-conditioner is running, press the ON/OFF button to stop.  
The airflow range setting cannot be made while the unit is running.

**2** Press the AIRFLOW U/D (UP/DOWN) button and the AIRFLOW L/R (LEFT/RIGHT) button together for 5 seconds or more.  
The airflow range setting display illuminates.

**3** Setting the airflow range.  
Press the AIRFLOW L/R (LEFT/RIGHT) button and adjust to the desired location.  
Each time the AIRFLOW L/R (LEFT/RIGHT) button is pressed, the display is switched in the order of:

(Center Installation) (Right End Installation) (Left End Installation)

**4** Press the ON/OFF button.  
The air-conditioner's airflow range is set.  
Press within 60 seconds of setting the airflow range (while the airflow range setting display illuminates).

## Air-conditioner installation location and airflow range

The diagram below indicates the airflow ranges corresponding to the air-conditioner's installation location. Consider your room's layout and set the airflow range to maximize air-conditioning.

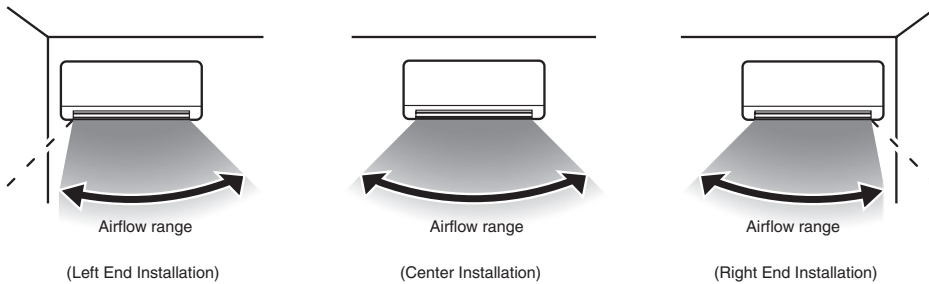

### NOTICE

- Once the airflow range setting is configured, it is stored in the air-conditioner even if the power source is turned off. To change the airflow range setting, set range again with the remote control.
- During the operation, an airflow range setting cannot be set.
- When the air-conditioner is installed at the location within 50 cm from the wall, it is recommended to change the airflow range setting to "Right End Installation" or "Left End Installation".

# Operation and display section for remote control

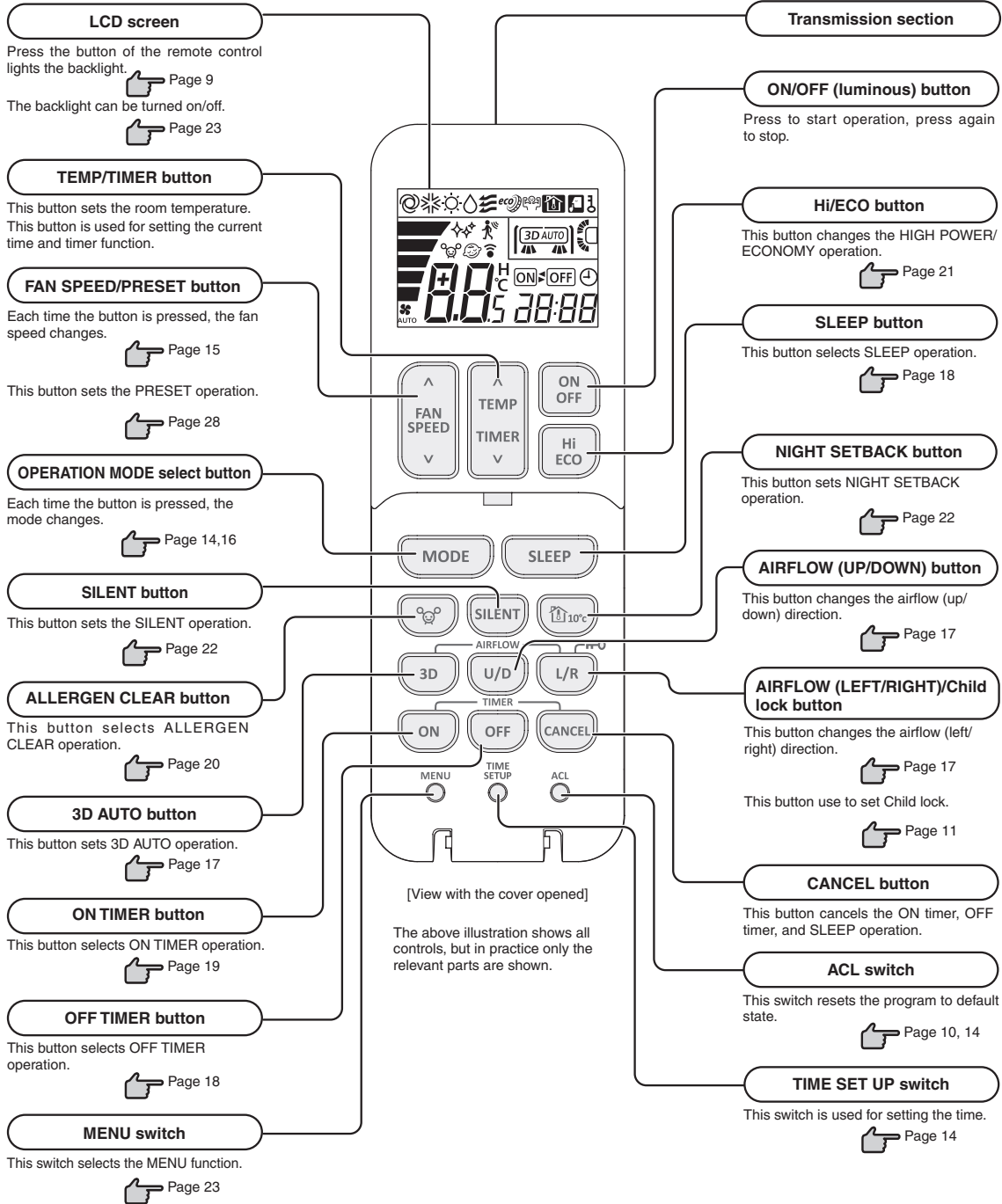

## Display in OFF status

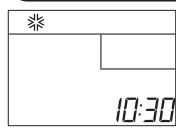

The current time and present OPERATING MODE are displayed while the air-conditioner is turned off.

## Transmission procedure

When each button on the remote control is pressed – with the remote control pointing towards the air-conditioner unit, a signal is transmitted.  
When the air-conditioner receives the signal correctly, it will beep.

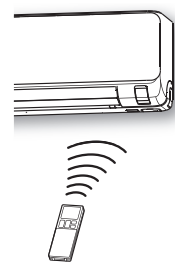

# Current time setting

- When inserting the batteries, the current time is automatically set to time setting mode. 13:00 is displayed as the current time. Set the clock to the right time.

Example: Set to 10:30.

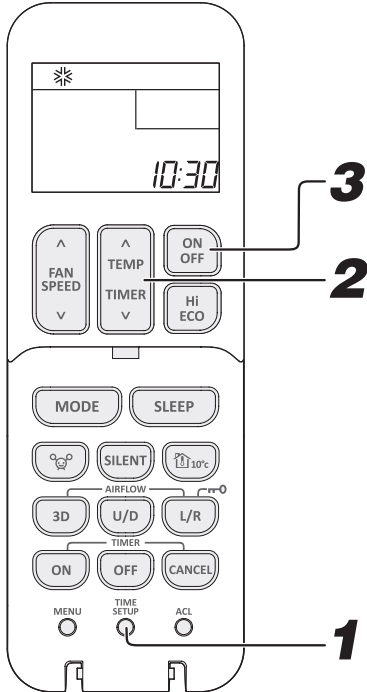

## 1

**Press the TIME SET UP switch.**

Press with the tip of a ballpoint pen, etc.  
The time display flashes and can be set to the current time.

## 2

**Press the “^ or v (TEMP/TIMER)” button.**

(Set to 10:30)

## 3

**Press the ON/OFF button.**

The time display changes from flashing to steady lighting and the setting is complete.  
Make sure to press the button within 60 seconds from the last operation in step 2, otherwise the time will not be set.

### NOTICE

- The timer operation works based on the time clock, so set it correctly.
- The remote control data will be reset when the present time is set.
- When the battery of the remote control is replaced or the ACL switch is pressed, the remote control will be set to the initial state.

# AUTO mode operation

- Automatically selects the operation mode (COOL, HEAT) depending on the room temperature when switched on.

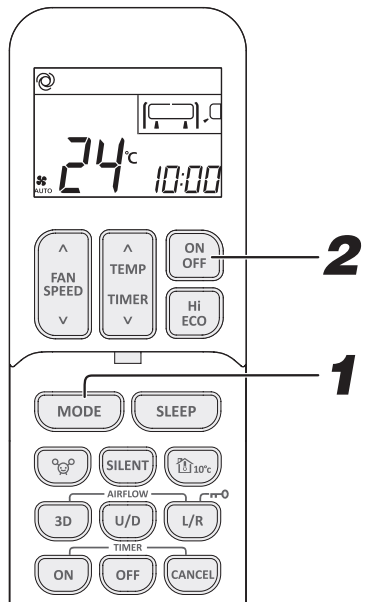

## 1

**Press the MODE button.**



The mode changes whenever the button is pressed.  
Set to .

## 2

**Press the ON/OFF button.**

**To stop:**

**Press the ON/OFF button.**

- If you do not want the AUTO mode program, change to COOL, HEAT or FAN instead of AUTO.  Page 16
- Airflow direction adjustment procedure.  Page 17

### NOTICE

- In case air is not blowing out during the operation.  Page 31



# Temperature adjustment during AUTO mode

- Default preset temperature during AUTO mode is 24 °C for both cooling and heating mode. However, it can be adjusted (Minimum 18 °C, Maximum 30 °C) using  $\wedge$  button or  $\vee$  button.

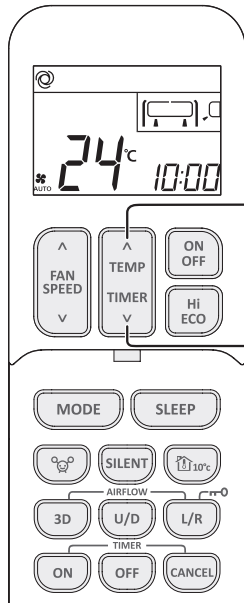

**1** Press the TEMP/TIMER button.

When it is a little cold

Press the  $\wedge$  button.

- Each time the  $\wedge$  button is pressed, the switch over occurs in the following order 18 → 18.5 → ..... 23.5 → 24 → 24.5 ..... → 30.
- When 30 is indicated, even if the  $\wedge$  button is pressed, the indicator does not change.

When it is a little hot

Press the  $\vee$  button.

- Each time the  $\vee$  button is pressed, the switch over occurs in the following order 30 → 29.5 → ..... 24.5 → 24 → 23.5 ..... → 18.
- When 18 is indicated, even if the  $\vee$  button is pressed, the indicator does not change.

# FAN SPEED

- The FAN SPEED can be set except for DRY mode.

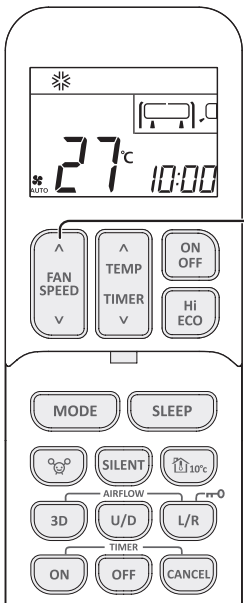

**1** Press the FAN SPEED button.

Press  $\wedge$  or  $\vee$  button for the preferred fan speed.

Operation capacity by your choice	FAN SPEED
Set automatically by microcomputer	AUTO
Silent operation	ULo
Energy-saving operation	Lo
Standard operation	Me
Powerful operation with high capacity	Hi

**NOTICE**

- When FAN SPEED is changed from Hi to Lo or ULo, the sound of refrigerant may be heard.
- When COOL mode is used if outside temperatures are low, the FAN SPEED may change automatically to protect the air-conditioner.

# COOL/HEAT/DRY/FAN mode operation

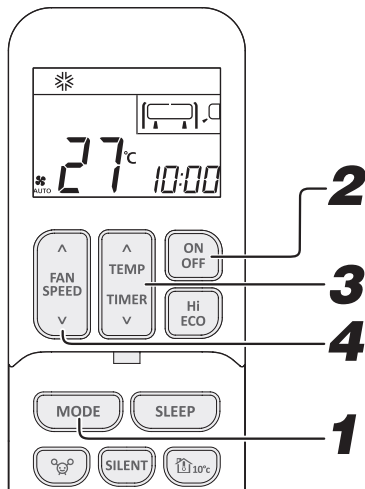

## 1 Press the MODE button.

Set to a required mode.

☼ (COOL), ☀ (HEAT), △ (DRY), ⚙ (FAN)

## 2 Press the ON/OFF button.

## 3 Press the TEMP/TIMER button.

Press ▲ or ▼ button for the preferred temperature.

Recommendation

COOL	HEAT	DRY	FAN
26 °C - 28 °C	20 °C - 24 °C	24 °C - 26 °C	—

## 4 Press the FAN SPEED button.

Set the fan speed as preferred.

A fan speed cannot be set under DRY operation.

Airflow direction adjustment procedure. Page 17

Page 15

### NOTICE

- In case air is not blown out, when starting the heating operation. Page 31
- The operation mode can also be set or changed when the air-conditioner is not in operation.

To stop:

Press the ON/OFF button.

# Air-conditioner operation temperature range

- Use within the following operational range. Operating outside of this range may result in the protection devices being activated and preventing the unit from working.

	COOL mode operation	HEAT mode operation
Outside temperature	Approximately -15 to 46 °C	Approximately -15 to 24 °C
Inside temperature	Approximately 18 to 32 °C	Approximately 10 to 30 °C
Inside humidity	Below approximately 80 % The long-term use of the unit with a humidity level exceeding 80 % may result in condensation forming on the surface of the indoor unit, leading to water drops.	

# Characteristics of HEAT mode operation

## Capacity of HEAT mode operation

- As a characteristic of heat pump system, the heating capacity reduces when the outside air temperature gets colder.
- It may take some time to supply warm air after turning on the air-conditioner.
- If the outside temperature becomes extremely low, it would be better to use an additional source of heating.

## Defrosting

If the outside temperature becomes low and humidity is high, the heat exchanger in the outdoor unit may frost over, which prevents efficient heating. **If this happens, the automatic defrost function is activated and the heating operation stops for 5 to 15 minutes during defrosting.**

- Both indoor and outdoor fans stop and the RUN light flashes slowly (1.5 seconds ON, 0.5 seconds OFF) during defrosting.
- The outdoor unit may release some steam during defrosting. This is to help the defrosting process and is not a defect.
- The HEAT operation resumes as soon as defrosting has been completed.

# Airflow direction adjustment

- Up/down direction can be adjusted with the AIRFLOW U/D (UP/DOWN) button on the remote control. Every time you press this button, the mode changes as follows:

Change on AIRFLOW (UP/DOWN) mode.

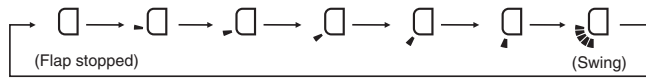

- Left/right direction can be adjusted with the AIRFLOW L/R (LEFT/RIGHT) button on the remote control. Every time you press this button, the mode changes as follows:

Change on AIRFLOW (LEFT/RIGHT) mode.

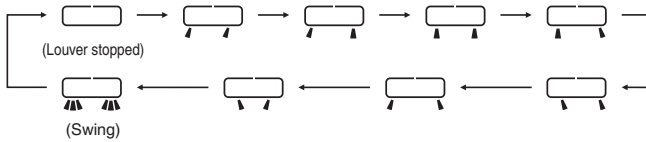

## NOTICE

- The actual position of the flap and louver may differ from the display shown.

## NOTICE FOR HEATING OPERATION

- When heating operation starts, the flap and louver direction is fixed at the horizontal/center position in order to avoid cold draft. It returns to the set position when the warm air supply is started.
- The flap and louver direction will be controlled to the horizontal/center position when the room temperature reaches the set temperature and compressor stops or when defrosting is in operation.
- The airflow direction cannot be set during the period mentioned above. Change the airflow direction settings after the warm air is supplied and the flap/louver goes to the set position.

## Memory flap (Flap or louver stopped)

When you press the AIRFLOW (U/D or L/R) button once while the flap or louver is operating, it stops swinging at the position. Since this angle is memorized in the microcomputer, the flap or louver will automatically be set at this angle when the next operation is started.

### WARNING

- Do not expose directly to airflow from the air-conditioner for a long time.

### CAUTION

- When in COOL or DRY operation, do not operate for a long period with the airflow blowing straight down. Otherwise, condensation may appear on the outlet grill and drip down.
- Do not try to adjust the flap and louver by hand, as the control angle may change or the flap or louver may not be closed completely.

- Recommended angle of the flap when stopping

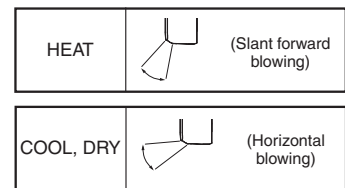

# 3D AUTO operation

- Fan speed and airflow direction are automatically controlled, allowing the entire room to be efficiently air-conditioned. When the air-conditioner is turned off, start the operation from Step 1. When the air-conditioner is running, start from Step 2.

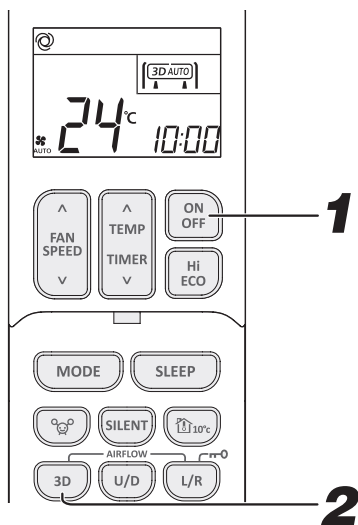

## 1

Press the ON/OFF button.

## 2

Press the 3D AUTO button.

Each time the 3D AUTO button is pressed, the display is switched in the order of:

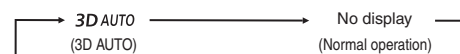

### How to cancel

Press the 3D AUTO button to turn off the 3D AUTO display.

### NOTICE

- 3D AUTO operation is canceled when you switch the operation mode.
- If 3D AUTO operation is canceled then the airflow direction changes to that used before 3D AUTO was set.
- 3D AUTO operation can be set in AUTO, COOL, or HEAT operation mode only.

# SLEEP TIMER operation

- The unit will stop automatically after the set time lapses.

The set temperature is automatically adjusted according to the lapse time in order to avoid too much cooling or heating.  Page 20

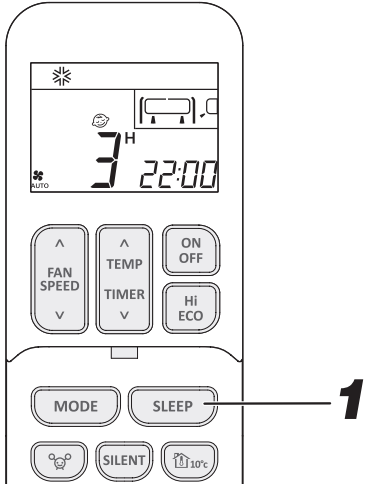

## 1 Press the SLEEP button.

- If it is pressed while the unit is off**

SLEEP TIMER operation starts with the previous operation settings, and the air-conditioner is turned off after the set time lapses.

- If it is pressed while the unit is running**

The air-conditioner is turned off after the set time lapses.

Every time the button is pressed, the display changes as follows:

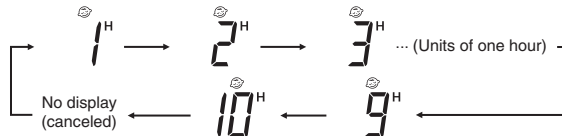

Example: You prefer it to stop after 3 hours.

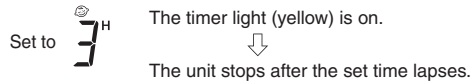

### Changing of set time

Set a new time by pressing SLEEP button.

### How to cancel

Press the CANCEL button to turn off the SLEEP display.

### NOTICE

- SLEEP TIMER operation cannot be set simultaneously with OFF TIMER operation or ALLERGEN CLEAR operation.

# OFF TIMER operation

- The unit stops automatically when the set time comes.

When the air-conditioner is turned off, start the operation from Step 1. When the air-conditioner is running, start from Step 2.

Example: You prefer it to stop 22:30.

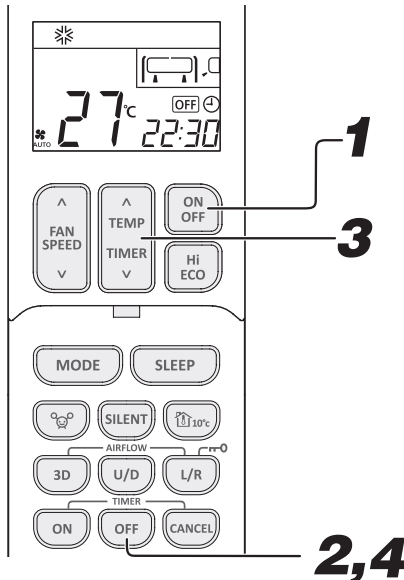

## 1 Press the ON/OFF button.

## 2 Press the OFF TIMER button.

OFF TIMER display [OFF] is flashing.

## 3 Press the TEMP/TIMER button.

Every time the  $\wedge$  button is pressed, the display is switched in the order of:

0:00 → 0:10 → 0:20 → ... → 1:00 → 1:10 → (Units of ten minutes)

Every time the  $\vee$  button is pressed, the display is switched in the order of:

0:00 → 23:50 → 23:40 → ... → 23:00 → 22:50 → (Units of ten minutes)

Set at 22:30.

## 4 Press the OFF TIMER button.

The display changes from flashing to steady lighting and the setting is complete.

The timer light (yellow) is on.

### NOTICE

- The unit stops at the end of the set period of time.
- Make sure to press the button within 60 seconds from the last operation in step 3, otherwise the setting is not completed.
- The current time is not displayed during OFF TIMER operation.
- OFF TIMER operation will not function during ALLERGEN CLEAR operation.
- Different from SLEEP TIMER operation, automatic set temperature adjustment is not done during OFF TIMER operation.

### Changing of set time

Set a new time by using the OFF TIMER button.

### How to cancel

Press the CANCEL button to turn off the timer display.

# ON TIMER operation

- Operation starts 5 to 60 minutes before the set time so that the room temperature reaches the optimum temperature at the set time. Page 20  
ON TIMER operation can be set regardless of whether the air-conditioner is running or not.

Example: When the preferred room temperature is required at 8:00.

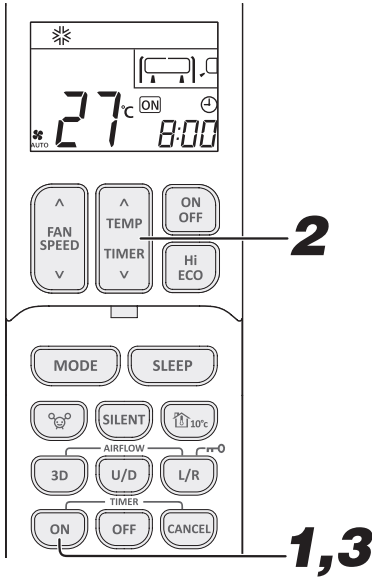

## 1 Press the ON TIMER button.

ON TIMER display is flashing.

## 2 Press the TEMP/TIMER button.

Every time the  $\wedge$  button is pressed, the display is switched in the order of:

$\rightarrow$  0:00  $\rightarrow$  0:10  $\rightarrow$  0:20  $\rightarrow$  ...  $\rightarrow$  1:00  $\rightarrow$  1:10  $\rightarrow$  (Units of ten minutes)

Every time the  $\nabla$  button is pressed, the display is switched in the order of:

$\rightarrow$  0:00  $\rightarrow$  23:50  $\rightarrow$  23:40  $\rightarrow$  ...  $\rightarrow$  23:00  $\rightarrow$  22:50  $\rightarrow$  (Units of ten minutes)

Set at 8:00.

## 3 Press the ON TIMER button.

The display changes from flashing to steady lighting and the setting is complete.

The timer light (yellow) is on.

If ON TIMER setting is performed when air-conditioner is running, air-conditioner operation will stop.

### NOTICE

- Operation starts 5 to 60 minutes before the set time.
- The timer light (yellow) goes out at the set time.
- Make sure to press the button within 60 seconds from the last operation in step 2, otherwise the setting is not completed.
- The current time is not displayed during ON TIMER operation.
- ON TIMER operation will not function during ALLERGEN CLEAR operation.
- If the ON/OFF button is pressed after setting the ON TIMER, the setting will be canceled.

### Changing of set time

Set a new time by using the ON TIMER button.

### How to cancel

Press the CANCEL button to turn off the timer display.

# SLEEP TIMER + ON TIMER operation

- This is the combined timer operation of SLEEP TIMER and ON TIMER.

Example: When it is required to stop after 3 hours and then start operation at 8:00, near the set temperature.

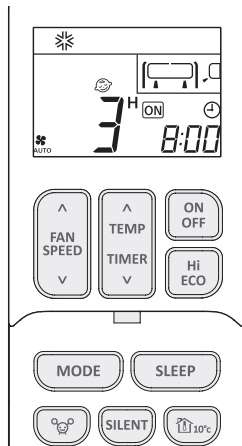

## 1 SLEEP TIMER setting

Set by the procedures on page 18.

Set to

## 2 ON TIMER operation setting

Set by the above procedure mentioned in ON TIMER.

Set to

The setting of the lighting of the timer light (yellow) of this unit is complete.



- After the SLEEP TIMER set time has lapsed, the operation stops, and it starts from 5 to 60 minutes before the ON TIMER's set time.
- The timer light is turned off when ON TIMER set time comes.

### NOTICE

- Pressing the ON/OFF button during SLEEP TIMER + ON TIMER operation switches to ON TIMER operation.

# PROGRAM TIMER operation

- This is the combined timer operation of ON TIMER and OFF TIMER. Once this has been set, the timer operations will be repeated at the same time every day unless the CANCEL button is pressed.

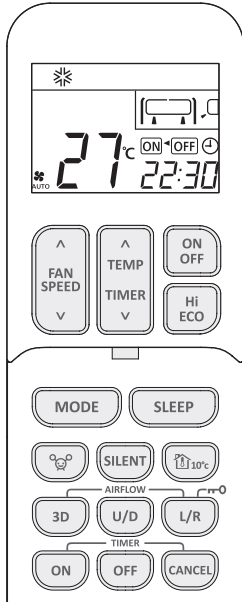

Example: Present time is 21:00. The air-conditioner running.

When it is preferred to stop at 22:30, and then start operation at 8:00, near the set temperature.

## 1 OFF TIMER operation setting

Set by the procedures on page 18.

Set to 22:30

## 2 ON TIMER operation setting

Set by the procedures on page 19.

Set to 8:00

Timer light (yellow) on the unit will light when the setting is completed.

- The set time will be displayed on the remote control. The display will change depending on the operational status.

- The air-conditioner stopping.  
 First the air-conditioner starts running with ON TIMER. After the air-conditioner stops running with OFF TIMER.
- The air-conditioner running.  
 First the air-conditioner stops running with OFF TIMER. After the air-conditioner starts running with ON TIMER.

### Changing of set time

Set a new time by using the OFF TIMER or ON TIMER button.

### How to cancel

Press the CANCEL button to turn off the timer display.

### Comfort Start-up

In ON TIMER operation, the unit starts the operation a little earlier, so that the room can approach optimum temperature at ON time. This is called "Comfort start-up".

- Mechanism  
 The room temperature is checked 60 minutes before the ON time. Depending on the temperature at that time, the operation starts 5 to 60 minutes before the timer is at ON.
- The function is available for COOL, HEAT and DRY operation mode (including AUTO).

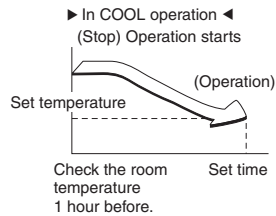

### SLEEP TIMER

When SLEEP TIMER is selected, the set temperature is automatically adjusted after a while, ensuring that the room is not too cold during cooling or too warm during heating.

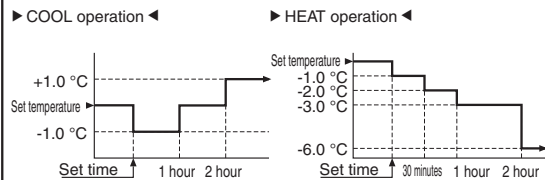

# ALLERGEN CLEAR operation

- Enzyme technology is used to eliminate allergens that accumulate on the "Allergen clear filter".

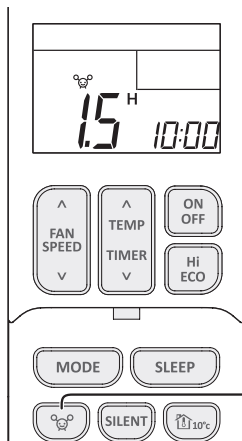

## 1

Press the ALLERGEN CLEAR button.

To stop:

Press the ON/OFF or ALLERGEN CLEAR button.

### NOTICE

- Since the room temperature may change quite a bit, it is recommended that this be used when no one is in the room. (It completes automatically in approximately 90 minutes.)
- During ALLERGEN CLEAR operation temperature, fan speed, airflow direction and timer operations settings cannot be made.

# HIGH POWER/ECONOMY operation

- When the air-conditioner is turned off, start the operation from Step 1. When the air-conditioner is running, start from Step 2.

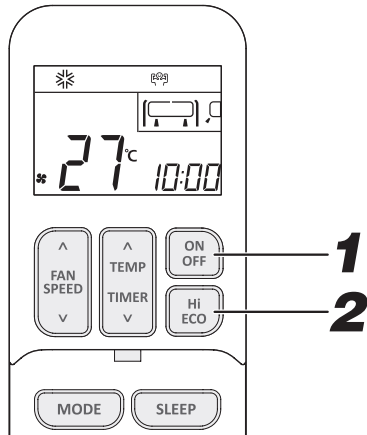

**1** Press the ON/OFF button.

**2** Press the Hi/ECO button.

- When the operating mode is AUTO, COOL or HEAT  
Every time the Hi/ECO button is pressed, the display is switched in the order of:



- When the operating mode is DRY or PROGRAM TIMER  
Every time the Hi/ECO button is pressed, the display is switched in the order of:

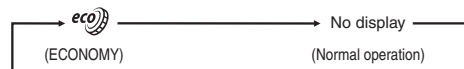

## HIGH POWER operation

Pressing the Hi/ECO button intensifies the operating power and initiates powerful cooling or heating operation for 15 minutes continuously. The remote control displays and the FAN SPEED display is disappeared.

### NOTICE

- During the HIGH POWER operation, the room temperature is not controlled. When it causes an excessive cooling or heating, press the Hi/ECO button again to cancel the HIGH POWER operation.
- HIGH POWER operation is not available during the DRY and PROGRAM TIMER operations.
- When HIGH POWER operation is set after setting ON TIMER operation, HIGH POWER operation will start from the set time.
- After HIGH POWER operation, the sound of refrigerant flowing may be heard.
- When the following operations are set, HIGH POWER operation will be canceled.
  - ① When the Hi/ECO button is pressed again. (The operation mode will be changed to the ECONOMY operation)
  - ② When the operation mode is changed.
  - ③ When it has been 15 minutes since HIGH POWER operation has started.
  - ④ When the 3D AUTO button is pressed.
  - ⑤ When the SILENT button is pressed.
  - ⑥ When the NIGHT SETBACK button is pressed.
- Not operable while the air-conditioner is OFF.

## ECONOMY operation

Pressing the Hi/ECO button initiates a soft operation with the power suppressed in order to avoid an excessive cooling or heating. The unit operates 1.5 °C higher than the setting temperature during cooling or 2.5 °C lower than that during heating. The remote control displays and the FAN SPEED display is disappeared.

### NOTICE

- It will go into ECONOMY operation at the next time the air-conditioner runs in the following case.
  - ① When the air-conditioner is stopped by ON/OFF button during ECONOMY operation.
  - ② When the air-conditioner is stopped in SLEEP or OFF TIMER operation during ECONOMY operation.
  - ③ When the operation is retrieved from SELF CLEAN or ALLERGEN CLEAR operation.
- When the following operations are set, ECONOMY operation will be canceled.
  - ① When the Hi/ECO button is pressed again.
  - ② When the operation mode is changed from DRY to FAN.
  - ③ When the NIGHT SETBACK button is pressed.
- Not operable while the air-conditioner is OFF.

# NIGHT SETBACK operation

- During the cold season, the room temperature can be maintained at a comfortable level during the absence, at night, and while the room is unattended. The air-conditioner maintains the constant temperature at about 10 °C.

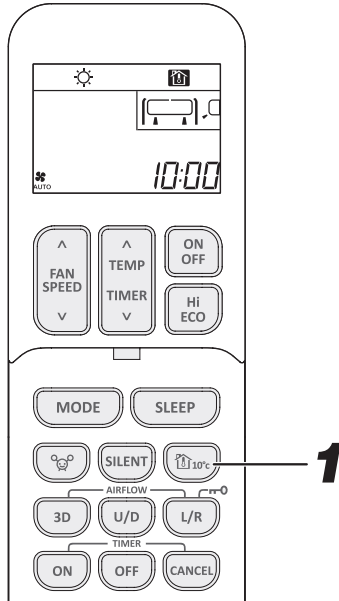

**1**

## Press the NIGHT SETBACK button.

Every time the NIGHT SETBACK button is pressed, the display is switched in the order of:

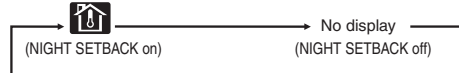

### How to cancel

Press the NIGHT SETBACK button or MODE button to turn off the NIGHT SETBACK display.

### NOTICE

- During NIGHT SETBACK operation, the air-conditioner maintains the set temperature at about 10 °C.
- During NIGHT SETBACK operation, temperature settings cannot be made.
- Since the room temperature may change quite a bit, it is recommended that this be used when no one is in the room.
- During NIGHT SETBACK operation, HIGH POWER and ECONOMY operations cannot be set.
- When NIGHT SETBACK operation is canceled by pressing the NIGHT SETBACK button, the operation mode is reset to the mode immediately prior to the NIGHT SETBACK operation.
- With this function, the air-conditioner maintains the room temperature at 10 °C during cold seasons (heating operation). The air-conditioner does not maintain the temperature at 10 °C during the hot/warm seasons (cooling operation). When the room temperature is higher than 10 °C, the fan will stop or operate at a low speed.

# SILENT operation

- When the SILENT operation is set, the unit operates more silently to reduce noise from the outdoor unit. When the air-conditioner is turned off, start the operation from Step 1. When the air-conditioner is running, start from Step 2. Two types of modes for SILENT operation can be selected. Page 26

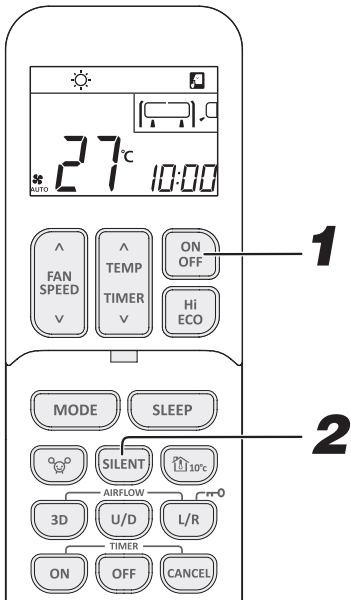

**1**

## Press the ON/OFF button.

**2**

## Press the SILENT button.

When the operating mode is AUTO, COOL, HEAT or NIGHT SETBACK Every time the SILENT button is pressed, the display is switched in the order of:

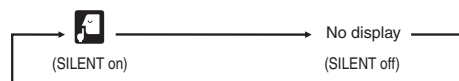

### How to cancel

Press the SILENT button to turn off the SILENT display.

### NOTICE

- During SILENT operation, the maximum cooling and heating capacities deteriorate.
- SILENT operation will not function during DRY and FAN operation.
- In case of following operations, the air-conditioner will resume SILENT operation whenever it turns ON again.
  - When the air-conditioner is stopped by ON/OFF button during SILENT operation.
  - When the air-conditioner is stopped in SLEEP or OFF TIMER operation during SILENT operation.
  - When the operation is retrieved from SELF CLEAN or ALLERGEN CLEAR operation.
- Not operable while the air-conditioner is OFF.
- The noise level of the outdoor unit may not decrease depending on the condition.



# MENU function

- MENU function is used for setting the Wireless LAN connection setting, Backlight setting, Display brightness adjustment, SELF CLEAN operation, Fan control in heating thermo - OFF, SILENT mode setting and Wireless LAN communication setting.

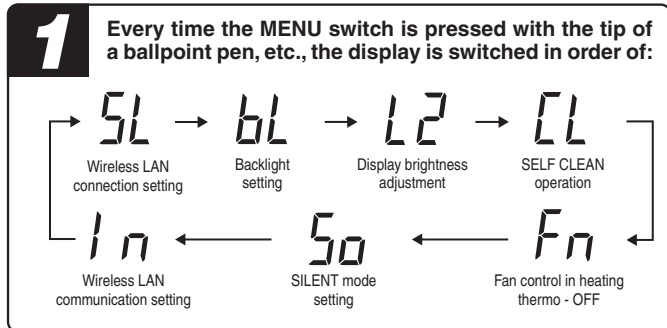
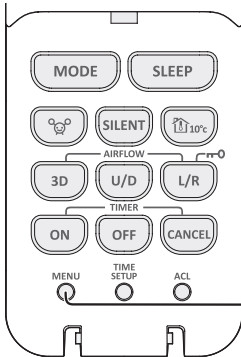

## Wireless LAN connection setting

- For Wireless LAN connection setting, refer to another user's manual.

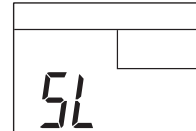

### NOTICE

- If the communication status is poor due to radio wave interference by an obstacle, microwave oven and so on, the operation contents may not be reflected. Check the operational status periodically.
- The operation contents of your smartphone are not reflected to the remote control display. The contents set by the remote control are reflected to the application (Smart M-Air).

## Backlight setting

- The backlight can be turned on/off.

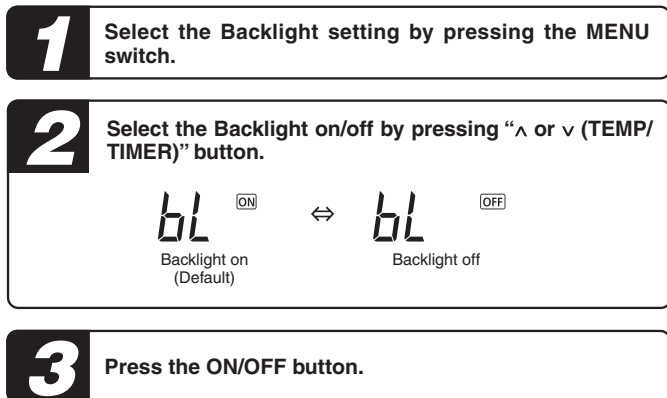
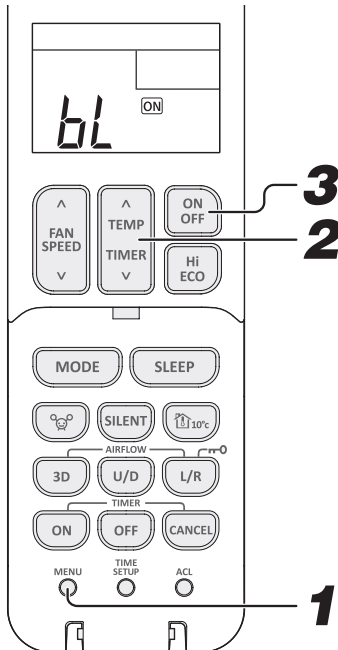

## Display brightness adjustment

- This function can be used when it is necessary to adjust the brightness of unit display.

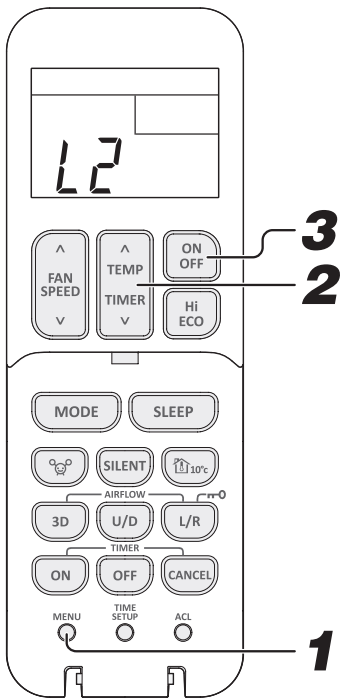

**1** Select the Display brightness adjustment by pressing the MENU switch.

**2** Select the brightness level by pressing “^ or v (TEMP/TIMER)” button.

L2 ⇄ L1 ⇄ L0  
 100% (Default)      50%      0% (Turned off)

**3** Press the ON/OFF button.

## SELF CLEAN operation

- SELF CLEAN operation should be run after AUTO, COOL and DRY operation to remove the moisture from inside of the indoor unit and control the growth of mold and bacteria. (Including when stopped by the TIMER)

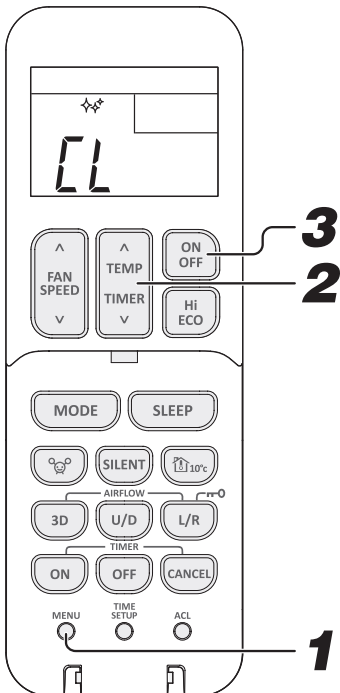

**1** Select the SELF CLEAN operation by pressing the MENU switch.

**2** Select SELF CLEAN on by pressing “^ or v (TEMP/TIMER)” button.

CL ⇄ CL<sup>✦</sup>  
 SELF CLEAN off (Default)      SELF CLEAN on

**3** Press the ON/OFF button.

### NOTICE

- Two hours later, the air-conditioner stops SELF CLEAN operation automatically. To stop the air-conditioner immediately, press the ON/OFF button.
- SELF CLEAN operation is not operated after HEAT, FAN and ALLERGEN CLEAR operations have finished.
- The indoor unit fan runs for about two hours in SELF CLEAN operation.
- The RUN light illuminates during SELF CLEAN operation (3 seconds ON, 1 second OFF).
- Pressing the SLEEP button, ALLERGEN CLEAR button or NIGHT SETBACK button during SELF CLEAN operation cancels the SELF CLEAN operation and then the unit is set to SLEEP, ALLERGEN CLEAR or NIGHT SETBACK operation.
- This is not a function for removing mold, germs or grime that have already adhered to the unit.

## Fan control in heating thermo - OFF

- When the room temperature reaches the set temperature during heating operation, the heating thermostat turns OFF. Fan control in heating thermo - OFF can be selected.

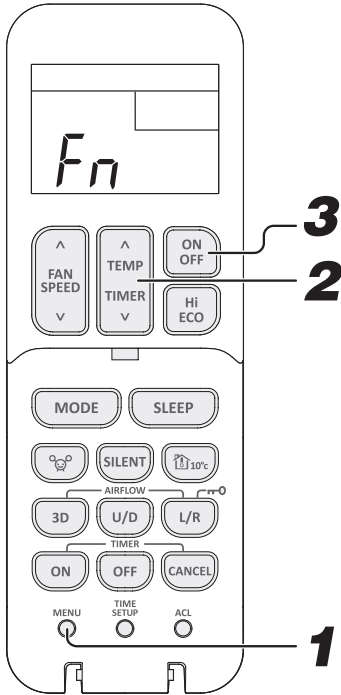

**1** Select the Fan control in heating thermo - OFF by pressing the MENU switch.

**2** Select the Fan control by pressing the “^ or v (TEMP/TIMER)” button.

$F_n \Leftrightarrow FP \Leftrightarrow FO \Leftrightarrow F1 \Leftrightarrow F2$

Initial display      Fireplace function      Normal function      Interval function      Stop function

<i>FP</i>	The unit operates at the FAN SPEED set by the remote control. Heat generated from other heat sources can be circulated in the room by operating the indoor fan continuously.
<i>FO</i>	The air-conditioner controls the FAN SPEED automatically.
<i>F1</i>	The indoor fan starts and stops the operation at regular intervals in order to avoid cold draft during heating thermo - OFF.
<i>F2</i>	The indoor fan stops. To use this function additional work is required, so consult your dealer. Otherwise, it may take time to return to heating and the heating capacity may be insufficient.

**3** Press the ON/OFF button.

### NOTICE

- Once Fan control in heating thermo - OFF is configured, it is stored in the air-conditioner even if the power source is turned off. To change Fan control in heating thermo - OFF, set again with the remote control.

## SILENT mode setting

- This function allows you to adjust the volume of the sound issued from the outdoor unit during SILENT operation in 2 levels.

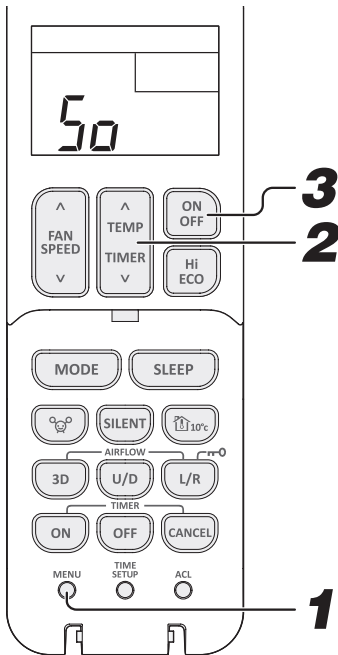

**1** Select the SILENT mode setting by pressing the MENU switch.

**2** Select the SILENT mode by pressing “^ or v (TEMP/TIMER)” button.

50 ⇔ 51 ⇔ 52  
 Initial display      SILENT mode 1      SILENT mode 2

51 This mode can reduce the noise from the outdoor unit.

52 This mode is ever more silently than the SILENT mode 1.

**3** Press the ON/OFF button.

### NOTICE

- Once SILENT mode setting is configured, it is stored in the air-conditioner even if the power source is turned off. To change SILENT mode setting, set again with the remote control.

## Wireless LAN communication setting

- The wireless LAN communication setting can be switched between ON and OFF.  
 Wireless LAN communication setting can be set regardless of whether the air-conditioner is running or not.

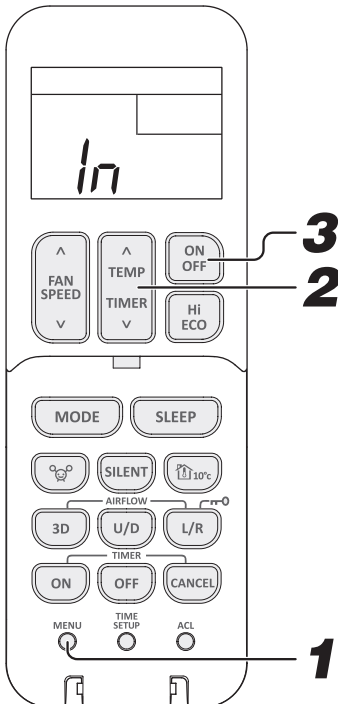

**1** Select the Wireless LAN communication setting by pressing the MENU switch.

**2** Select the Wireless LAN communication setting by pressing “^ or v (TEMP/TIMER)” button.

ln ⇒ ln <sup>ON</sup> ⇔ ln <sup>OFF</sup>  
 Initial display      Wireless LAN communication ON      Wireless LAN communication OFF

**3** Press the ON/OFF button.

### NOTICE

- Once Wireless LAN communication setting is configured, it is stored in the air-conditioner even if the power source is turned off. To change Wireless LAN communication setting, set again with the remote control.
- If the Wireless LAN communication setting is set to OFF, the wireless LAN connection function will be unavailable.

# Initialization of wireless LAN setting

- If you want to reset the wireless LAN setting, it can be initialized to the status at the time of purchase. When the wireless LAN setting is initialized, data of such as the network setting is erased.

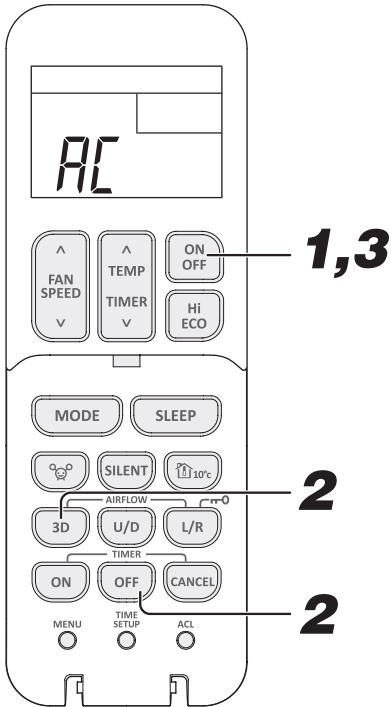

## 1 If the air-conditioner is running, press the ON/OFF button to stop.

The initialization of the wireless LAN setting cannot be made while the unit is running.

## 2 Press the OFF TIMER button and the 3D AUTO button together for 5 seconds or more.

The AC display on the remote control blinks.

## 3 Press the ON/OFF button for 5 seconds.

When completed, RUN light and TIMER light flash twice.

### How to cancel

Press the CANCEL button to turn off the setting display.

### NOTICE

- Be sure to initialize the setting when the user of the air-conditioner changes or the air-conditioner is disposed of.

# PRESET operation

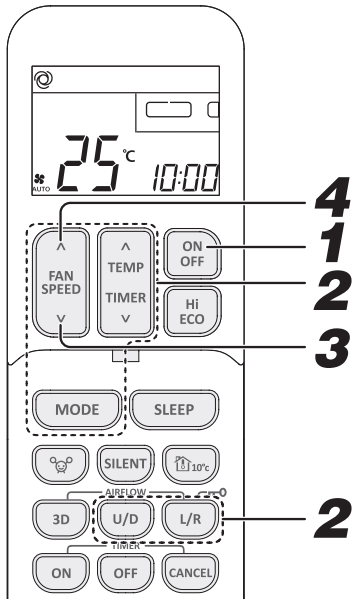

## How to save

- This operation can save the preferred setting for future operation. When the air-conditioner is turned off, start the operation from Step 1. When the air-conditioner is running, start from Step 2.

**1** Press the ON/OFF button.

**2** Select preferred OPERATION MODE, TEMPERATURE, FAN SPEED and AIRFLOW direction.

**3** Press “FAN SPEED v” button 3 seconds or more.  
The preferred setting for future operation will be saved.  
ⓘ is displayed for a moment.

## How to start

- Operation can be performed with saved settings.

**4** Press “FAN SPEED ^” button 3 seconds or more.  
PRESET operation will start.

## NOTICE

- When pressing “FAN SPEED ^” button 3 seconds or more for PRESET operation during the 3D AUTO or HIGH POWER operation, it will be canceled.
- When pressing “FAN SPEED ^” button 3 seconds or more for PRESET operation during the ECONOMY operation, it will continue.

# Maintenance

## Before maintenance

Turn off the power source.



- Do not spill any liquid to the unit.
- Do not touch the aluminum fins on the heat exchanger.
- Stand firmly on a stepladder or other stable object when removing the inlet panel and filter.

Do not use the following items:

- Hot water (40 °C or more)  
It may deform or discolour the unit.
- Petrol, paint thinner, benzine or cleanser, etc. It may deform or scratch the unit.

## During the operational season

### Cleaning the air filter

Standard interval is once every two week

#### 1 Remove the air filter

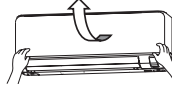

- Pull up the air inlet panel forward.
- Lightly hold the knobs both sides and lift a little to remove the panel forward.



#### 2 Cleaning

If the filter is very dirty, clean it with warm water (approx. 30 °C), and dry it thoroughly.

- CAUTION**
- Do not clean the filters with boiling water.
  - Do not dry them over an open flame.
  - Pull them out gently.



#### 3 Reinstall the air filter

- Hold firmly the filter at both sides as shown at right and insert securely.
- Operating without the air filters will make the unit dusty, and may cause damage.



### Cleaning the unit

- Wipe the unit with a soft, dry cloth, or use a vacuum cleaner.
- If the unit is very dirty, wipe it with a cloth soaked in warm water.

### Cleaning the air inlet panel

- The panel can be washed with water. After washing with water, wipe any moisture off the panel and dry it out of direct sunlight.

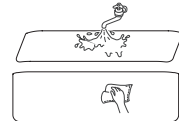

## How to open and close the air inlet panel

### Open

Place thumbs on both sides of the lower part of the panel and pull up the panel forward so that it will be opened by about 60 degrees.

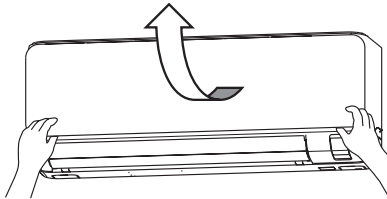

### Close

Push both corners of the panel evenly and press further lightly at the center.

## How to remove and install the air inlet panel

### Removing

When removing the air inlet panel for internal cleaning or others, open the panel by 90 degrees and then pull it forward.

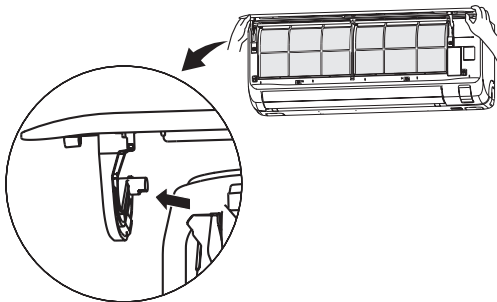

### Installing

Insert the panel arm into the slot on the front panel from the position shown below, hold the panel at both ends of lower part, lower it downward slowly, then push it slightly until the latch works.

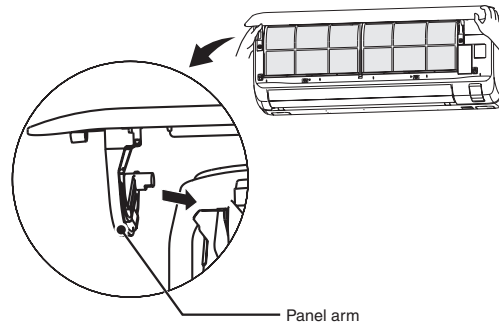

Panel arm

## Maintenance

### NOTICE

- Cooling/heating is affected by an air filter clogged up with dust etc., and the operation noise becomes louder. It may also use extra electricity. Please clean the air filter at appropriate intervals.

### At the end of the season

#### 1 Perform the fan operation for 2 to 3 hours.

Dry the inside of the unit.

#### 2 Stop the unit and turn off the power source.

The unit consumes approx. 4 W even when the unit is not operating. Turning off the power source will help saving energy consumption and cost.

#### 3 Clean and reinstall the air filters.

#### 4 Clean both the indoor and outdoor units.

#### 5 Remove batteries from the remote control.

### At the beginning of the season

#### 1 Ensure that the earth wiring is not snapped nor disconnected.

#### 2 Make sure that there is no corrosion or rust on the base frame of the outdoor unit.

#### 3 Make sure that there are no obstacles blocking the airflow around the air intake and outlet openings of the indoor and outdoor units.

#### 4 Turn on the power source.

#### 5 Insert batteries in the remote control.

## Installing, inspecting and replacing the air-cleaning filter

1. Open the air inlet panel and remove the air filters.  Page 29
2. Remove the allergen clear filter (Light orange) from air-conditioner and inspect the filter. Use a vacuum cleaner to remove any dust or dirt from the allergen clear filter. Replace the allergen clear filter if it cannot be cleaned or if it has been for about 1 year.  
(The allergen clear filter should be replaced after about 1 year of used. However, the actual replacement period may vary depending on the conditions in which the filter is used.)
3. Install the air-cleaning filter in the air-conditioner.

### NOTICE

- Install the allergen clear filter with the light orange side on front side.

4. Install the air filters and close the air inlet panel.  Page 29

### CAUTION

- The heat exchanger may injure your fingers.
- Stand firmly on a stepladder or other stable object when removing the air inlet panel and filters.

For replacing the air-cleaning filter, contact your dealer.

Item	Feature	Color
Allergen clear filter	Enzyme technology is used to eliminate allergens that accumulate on the "Allergen clear filter".	Light orange

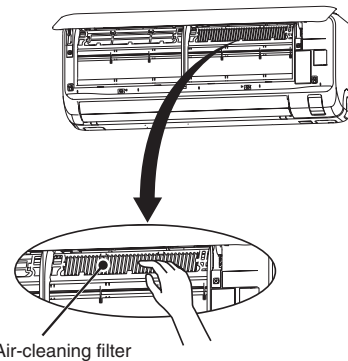



# Proper installation

## Suitable installation position

- Do not put any obstruction in front of the indoor unit, preventing proper ventilation and functioning.
- Do not install the unit in any of the following places:
  - Where there is a danger of leaking flammable gases.
  - Where there is substantial splashing of oil.
- Malfunctioning due to corrosion may occur if the unit is installed in a spa where sulfide gases are generated, or in a seaside resort exposed to sea breezes. Contact your dealer.
- The air-conditioner and remote control must be at least 1 meter away from a TV set or radio.
- Drain the dehumidified liquid from the indoor unit into a spot that drains well.

## Pay attention to operating noises

- When you install the unit, take care to choose a place that can comfortably stand the weight of the unit and does not increase the operating noise or vibration. If vibration is transmitted through the house, fix the unit with the aid of vibration-proof pads between the unit and the fittings.
- Select a place where cold or hot air, operation noises from the indoor and outdoor units do not cause any inconvenience to your neighbours.
- Do not leave any obstacles near the outlet and inlet of the outdoor unit. This may cause malfunctioning and increased operating noise.
- If you hear an irregular noise during operation, contact your dealer.

## Inspection and maintenance

Depending on operating environment, the inside of the air-conditioner may become dirty after a few year operations. This will reduce performance. In addition to normal cleaning, we would recommend inspection and maintenance. (This may lead the air-conditioner to having a longer life without any trouble.)

- Contact your dealer, or any distributor, for inspection and maintenance. (There will be a charge for this service).
- We would recommend inspection and maintenance to be carried out during the off-season.
- If the supply cord of this appliance is damaged, it must only be replaced by a repair shop appointed by the manufacturer, because special purpose tools are required.

# Troubleshooting

Please carry out the following checks before making a service call.

### The air-conditioner does not work at all.

- Has the power source been turned on?
- Has the timer been set in the "ON" position?
- Is there a power failure or a blown fuse?

### Poor cooling or heating

- Have you set the thermostat at a suitable temperature?
- Is the air filter clean? (Not clogged?)
- Have you left any doors or windows open?
- Is there any direct sunlight entering the room?
- Is there a heat source in the room?
- Are there too many people in the room?

In the following cases, switch off the power and contact your dealer.

- If the air-conditioner does not operate properly after you have checked the left points.
- If any doubt still exists after you have consulted the Notice (page 31 - 32).
- If things happen as shown on page 33.

# Notice

## Airflow

<b>Air is not blown out when starting the HEATING operation.</b> RUN light flashes slowly (1.5 seconds ON, 0.5 seconds OFF)	Airflow has stopped to prevent blowing out of cold air until the indoor heat exchanger has warmed up. (2 to 5 minutes)
<b>Air is not blown out for 5 to 15 minutes or cool air is blown out for a moment at HEATING operation.</b> RUN light flashes slowly (1.5 seconds ON, 0.5 seconds OFF)	When outdoor temperature is low and humidity is high, the unit sometimes performs defrosting automatically. Please wait. During defrosting, water or steam may release from the outdoor unit.
<b>Air is not blown out when starting the DRY operation.</b> (RUN light is on)	The indoor fan may stop to prevent re-evaporation of dehumidified moisture and to save energy.

## ■ Notice

### Noise

You hear a slight gurgling sound.	This is caused by refrigerant moving within the unit.
You hear a slight cracking sound.	This is caused by heat expansion or contraction.
You hear a hissing or clicking sound.	This is caused by the operation of the refrigerant control valves or electric components.
Whistling noise is heard from the outdoor unit.	This means that the rotation speed of the compressor is increasing or decreasing.
In case of SCM multi system, sometimes a "Shooooo" sound might come for a short time from the unit that is turned off.	This is the sound when operation of another indoor unit is stopped.

### Operation

The timer function is canceled.	<p><u>Timer function used with wired remote control / WF-RAC (Smartphone)</u></p> <p>The following timer functions that have been set from the wireless remote control are cancelled when the operating status of the indoor unit changes due to signals from the wired remote control or WF-RAC (Smartphone). At this time, the operational status of the indoor unit is different from the wireless remote control display. Therefore it is recommended to only set one of the timers.</p> <ul style="list-style-type: none"> <li>• SLEEP TIMER operation</li> <li>• OFF TIMER operation</li> <li>• ON TIMER operation</li> <li>• SLEEP TIMER + ON TIMER operation</li> <li>• PROGRAM TIMER operation</li> </ul>
The wireless remote control display and operating conditions do not match.	

### Others

The unit does not restart immediately after you have stopped it. (RUN light is on)	<p>Restart is blocked for 3 minutes after you have stopped the operation to protect the unit.</p> <p>The 3 minutes protection timer in the microcomputer automatically starts it up again.</p>
Some steam releases during COOL operation.	<p>This may occur if the room's temperature and humidity are very high. It disappears as soon as the temperature and humidity decrease.</p> <p>Close all windows and doors to prevent outside humidity from entering.</p>
There is a slight smell.	<p>Air blown out during operation may smell. This is caused by tobacco or cosmetics adhering to the unit.</p>
After a power cut, the unit does not restart even if power has been restored.	<p>If the auto restart function is not set, the unit will not restart automatically. Use the remote control to start the operation again.</p>
Remote control signals are not received.	<p>Remote control signals may not be received if the signal receiver on the air-conditioner is exposed to direct sunlight or other bright light.</p> <p>If so, block the sunlight or reduce the other light.</p>
Moisture may form on the air outlet grills.	<p>If the unit is operated for a long time in high humidity, moisture may form on the air outlet grills and start dripping.</p>
Fan will not stop immediately after unit operation is stopped.	<p>Indoor fan : Fan will not stop after 2 hours if set to SELF CLEAN operation.</p> <p>Outdoor fan : Fan will not stop about a 1 minute period in order to protect the unit.</p>
RUN light stays on even though operation was stopped.	<p>The RUN light illuminates during SELF CLEAN operation. Run light will turn off when SELF CLEAN operation ends.</p>

# Contact your dealer

■ Turn off the power switch immediately and inform your dealer in any of the following situations:

- The fuse or switch blows continuously.
- The cable becomes extremely hot.  
The covering of the cable is cracked.
- The TV, radio or other equipment starts to malfunction.
- A switch does not activate properly.
- A strange noise is heard during operation.
- When abnormalities occur, turn off the power source immediately and turn it on after 3 minutes. Restart the operation with ON/OFF button of the remote control and the abnormalities still continue.
- The RUN and TIMER lights on the unit display section flash quickly (in a 0.5 seconds interval) or the lights do not work.

# Auto restart function

■ Auto restart function records the operational status of the air-conditioner immediately prior to be switched off by a power cut, and then automatically resumes operations after the power has been restored.

■ The following settings will be canceled:

- Timer settings
- HIGH POWER operations

## NOTICE

- Auto restart function is set at on when the air-conditioner is shipped from the factory. Consult with your dealer if this function needs to be switched off.
- When power failure occurs, the timer setting is canceled. Once power is resumed, set the timer again.

# Self diagnosis function

■ We are constantly trying to do better service to our customers by installing such judges that show abnormality of each function as follows

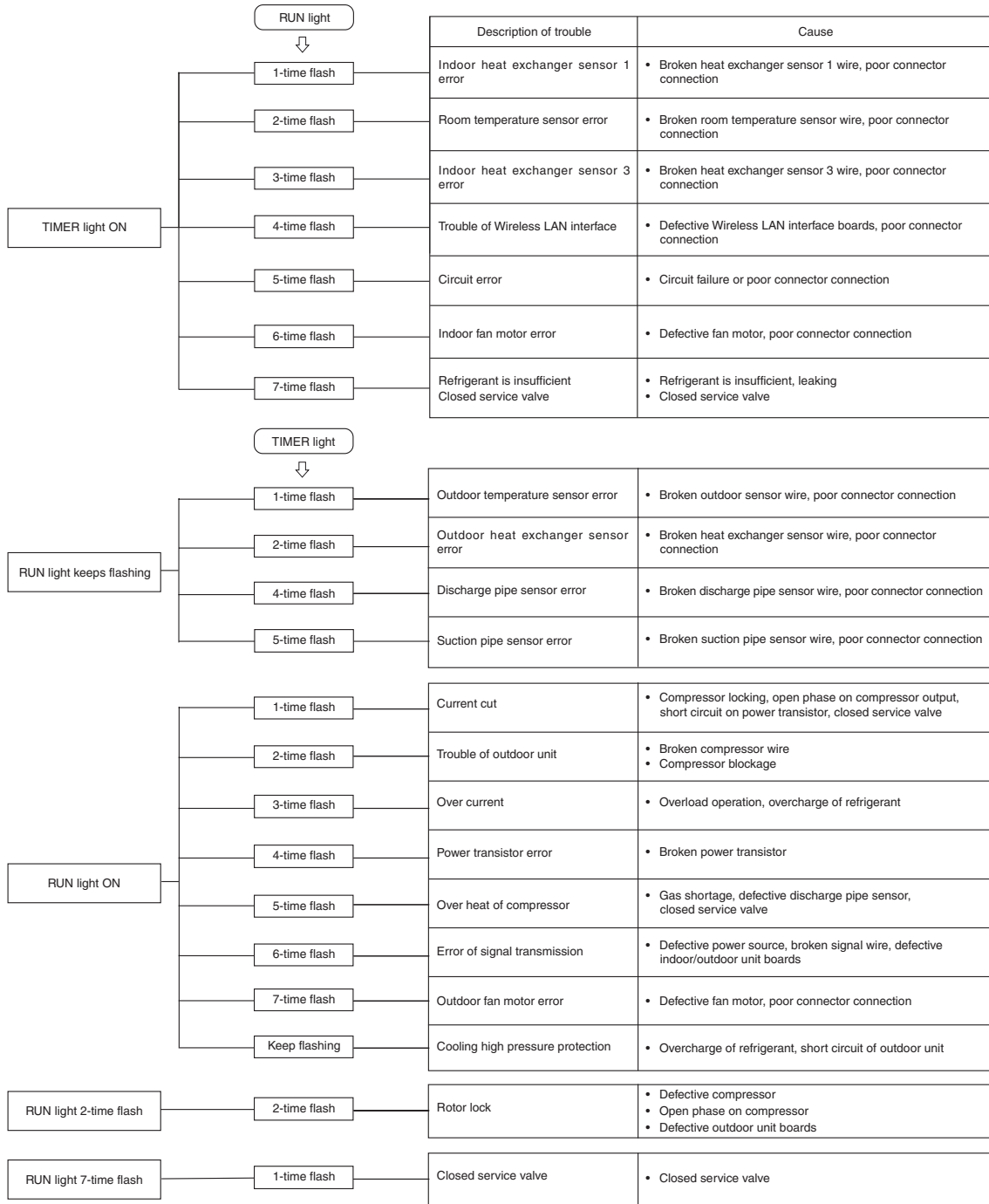

# DRED

- This air-conditioner complies with the DRED (Demand Response Enabling Devices) standard AS/NZS4755.3.1 and supports demand response modes 1, 2 and 3 (DRM1, 2 and 3). Since the air-conditioner limits the electric power or energy by receiving the DRED input signal, the sense of cooling operation or heating operation may deteriorate over time. The outdoor unit of this air-conditioner is equipped with a terminal block for DRED input and supports ELV (Extra-Low Voltage) complying with AS/NZS60335.1. Under DRED mode, RUN light and TIMER light flash alternately as shown. When the Defrost function becomes effective during DRED operation, the TIMER light flashes quickly.

## Display in DRED mode

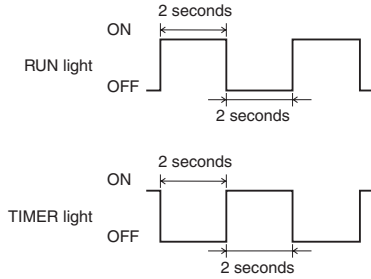

## Display in DRED mode during Defrost operation

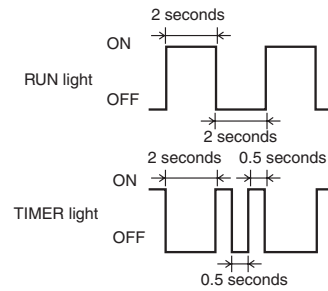

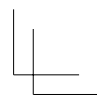
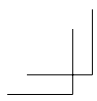

EN-36

