

Catalogue No: **D7PSM22PX10HS**

HANGSELL SEL SW 22.5mm PLASTIC 2P 1NO WHITE

Operator Control Devices > Pushbuttons and Control Switches > Pushbuttons and Pilot Lights > Sprecher + Schuh D7 Pushbuttons and Pilot Lights > D7 Selector and Key Selector Switches > Selector Switches Complete

SELECTOR SW 22.5mm PLASTIC 2 POSITION WHITE 1N/O HANGSELL



Representative Photo Only
(actual product may vary based on configuration selections)

- D7 pilot devices offer maximum flexibility and a wide choice for all 22.5mm operator applications with all type (e-stops, selector switches, pushbuttons, pilot lights and more), colour and contact configurations.
- Aesthetically appealing and modularly designed to make assembly and interchangeability easy.
- Operators exhibit low profile and stylish appearance while maintaining the rugged performance necessary for demanding environments
- D7P is a plastic operator with a captive black plastic front bezel. Constructed of high grade thermoplastics, the D7P operators provide strong chemical resistance making them suitable for use in different environments
- D7M has a die-cast zinc housing and mounting ring for rugged durability. Finished with corrosion resistant chrome plating, the D7M also features a captive shiny metal bezel for a polished appearance.

SPECIFICATIONS

Product Series	D7P
Component Type Pushbutton and Pilot Lights	Selector Switch
Operator Type	Selector Switch, Knob, 2-Position type
Number of Positions	2
Key	No Y / N
Operator Action, Left	Latched / Maintained
Operator Action, Right	Latched / Maintained
Colour, Operator	Black colour
Material, Operator	TP (Thermoplastic) material
Colour, Operator Insert	White
Material, Bezel	Glass-Filled Nylon / PA6 / PA66 (Polyamide 6)
Coupling Plate Included	Yes Y / N
Material, Latches	Glass-Filled Nylon / PA6 / PA66 (Polyamide 6)
Mounting	22.5mm Mounting
Contact Block Included	Yes
Ie, Rated Operational Current, AC-1, 240V	10 A@240V
Ie, Rated Operational Current, AC-15, 110-120V	6 A@110-120V
Ie, Rated Operational Current, AC-15, 240V	3 A@240V
Ie, Rated Operational Current, AC-15, 415V	2.2 A@415V
Ui, Rated Insulation Voltage	690 V (rms)
Compatible Product Series	D7 22.5mm Control & Indication compatible
Material, Contacts	Silver Nickel (AgNi) material
Terminal Type	Screw Terminal(s)
Material, Terminal	Brass
Tightening Torque, Min	0.7 Nm
Tightening Torque, Max	0.9 Nm
Material, Spring	Zinc-Plated Stainless Steel
Ith, Thermal Current, Open	10 A

Catalogue No: **D7PSM22PX10HS**

HANGSELL SEL SW 22.5mm PLASTIC 2P 1NO WHITE

Operator Control Devices > Pushbuttons and Control Switches > Pushbuttons and Pilot Lights > Sprecher + Schuh D7 Pushbuttons and Pilot Lights > D7 Selector and Key Selector Switches > Selector Switches Complete



Wire / Conductor Size (Min)	0.75 mm ² min
Wire / Conductor Size (Max)	2.5 mm ²
Dielectric Strength	2.5kV for 1 minute V AC
Recommended Fuse Current Rating	10 A
Fuse Characteristic Type(s)	gL/gG
Tightening Torque, Nominal	1.7 Nm
Mechanical Service Life	300000 cycles
RoHS Approved	Yes
CE Marked	Yes
Operating Temperature, Max	70 °C max
Operating Temperature, Min	-25 °C min
Storage Temperature, Max	85 °C max
Storage Temperature, Min	-40 °C min
Relative Humidity, Min	50 %RH
Relative Humidity, Max	95 %RH
IP Rating	IP65 IP66
Shock Acceleration (Max.)	100 g
Shock Duration (Max.)	11 ms
Vibration Acceleration (Max.)	10 m/s ²
Vibration Displacement (Peak to Peak Max.)	1.52 mm
Vibration Frequency, Operational (Max.)	2000 Hz
Vibration Duration (Max.)	180 min
Standards Compliance	NEMA ICS-5 UL 508 EN 60947-1 EN 60947-5-1 EN 60947-5-5 EN 418
Certifications	UL UR CSA CCC CE
Shipping Approvals	RINA (Registro Italiano Navale) ABS (American Bureau of Shipping) Lloyd's Register of Shipping

REFERENCES

IECEx Certificate	-
Supplier Declaration of Conformity:	-
Installation Guide:	-
User Manual:	-
Manufacturer Datasheet:	Series D7_Manufacturer Datasheet
Manufacturer Catalogue & Product Selection:	-

Catalogue No: **D7PSM22PX10HS**

HANGSELL SEL SW 22.5mm PLASTIC 2P 1NO WHITE

Operator Control Devices > Pushbuttons and Control Switches > Pushbuttons and Pilot Lights > Sprecher + Schuh D7
Pushbuttons and Pilot Lights > D7 Selector and Key Selector Switches > Selector Switches Complete

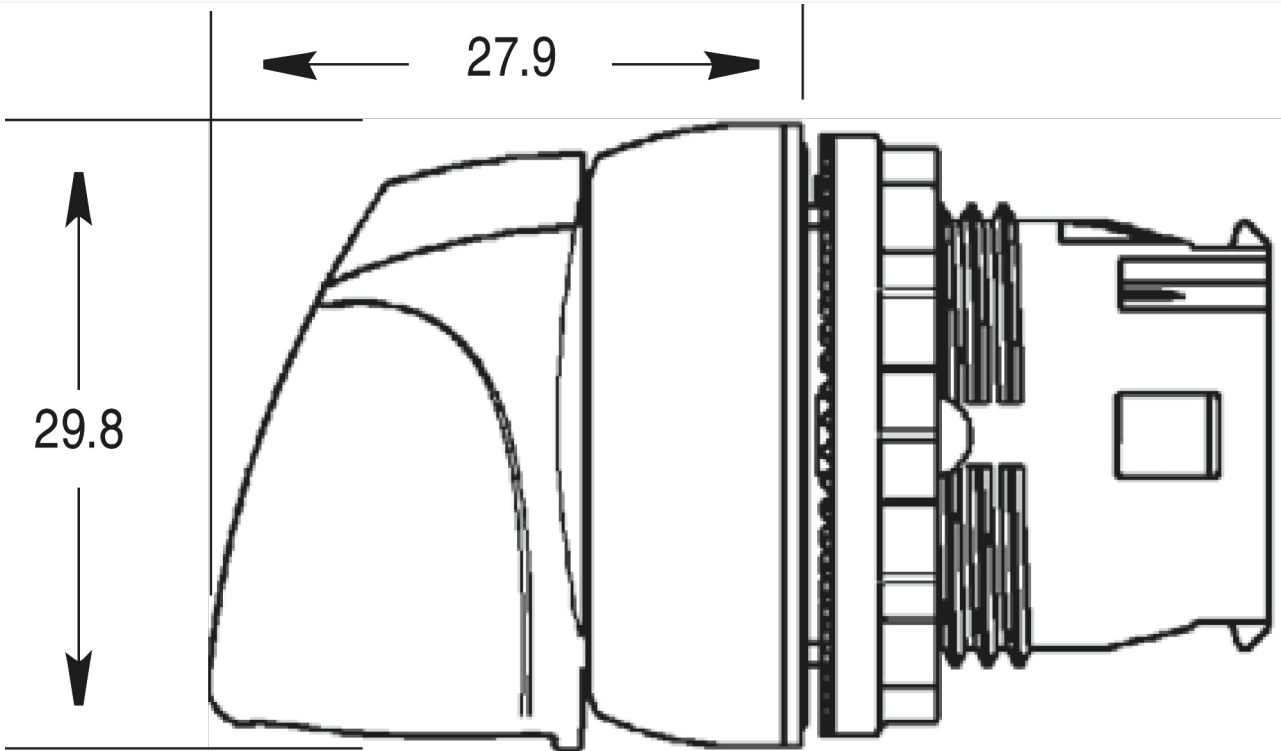

Dimension Diagram