

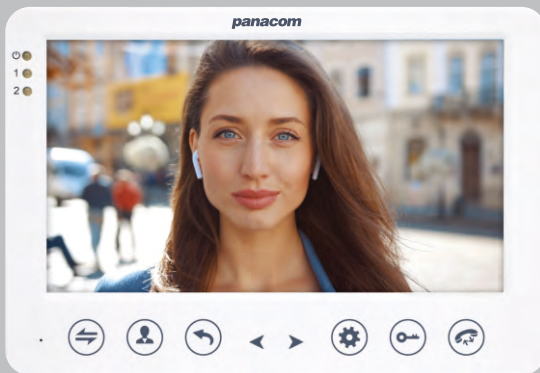

panacom[®]

COLOUR HD VIDEO INTERCOM INSTRUCTION MANUAL

“Choose **PSA** for intercoms”



PAN920SKHD

APRIL 2020

FIRE • SECURITY • INTERCOMS

psaproducts.com.au

CONTENTS

	PAGE
1 Features	3
2 Kit Contents	3
3 Outdoor Camera Specification	4
4 Installation of Outdoor Camera	5
5 Indoor Monitor Specifications	6
6 Installation of Indoor Monitor	8
7 Installation Notes	9
8 Wiring Diagram	10
9 Alarm Instructions	13
10 Operating Instructions	14
11 Monitoring	15
12 Call transfer to other extension	16
13 Internal communication among indoor units	16
14 Menu Operation	17
15 Warranty & Liability	30

1. FEATURES

- 7" TFT LCD screen plastic housing
- Support 6 monitors, 2 door stations with extra 2 CCTV Cameras and 2 PIR sensors
- Missed call feature: when doorbell is not answered, a notification icon will be shown. (note: Date/Clock feature must be activated)
- Different ringtones for Door A & Door B
- Support 32G MicroSD for pictures or video recording
- Picture memory when MicroSD card fitted (MicroSD card not supplied)
- IP 65 surface mount Door Station
- Digital Photo Frame (Displays photos from MicroSD card)
- Monitoring function
- Hands-free intercom doorbell function
- Call transfer function
- Door release function
- Twelve polyphonic melodies
- Ringtone volume adjustable settings for morning / afternoon / evening
- Ring volume, talking volume, chroma and brightness adjustable
- Motion picture recording when MicroSD card installed (MicroSD card not supplied)
- Custom melody as ringtone

2. KIT CONTENTS

- One indoor monitor
- One Door Station
- One adapter
- One bracket for indoor monitor
- One angle bracket
- Accessory pack

3.DOOR STATION SPECIFICATION

Camera sensor	1/3 inch wide angle CMOS camera
View angle	110°
Definition(Hor.)	960P
LEDs for night	IR LEDs(120°)
Power consumption	150mA max.
Power source	Supplied from indoor unit
Operation temp.	-40~+50℃
Installation	Surface mounted
Lock	N/O, N/C Contact (30VDC 2A)
Ingress Protection Rating	IP 65
①	IR LEDES
②	Camera
③	Speaker
④	Call button
⑤	Microphone
⑥	Volume regulator
⑦	System port

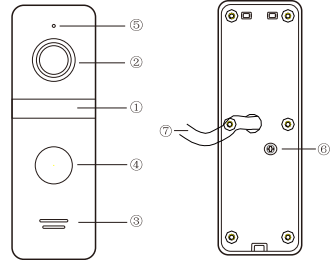
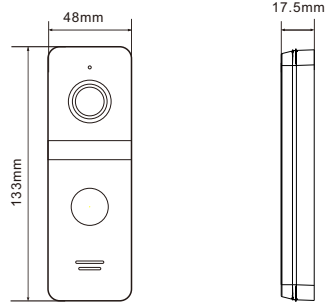

Wire Colour Configurations:

RED	12Vdc
WHITE	Audio
BLACK	Ground
YELLOW	Video
ORANGE	Relay COM
GREEN	Relay N/O
BROWN	Relay N/C
BLUE	Voltage Camera + Input
GREY	Voltage Camera - Input
PURPLE	Voltage Lock + Output

Front of surface mount camera PAN921SCHD

4.INSTALLATION OF DOOR STATION

Angle mount

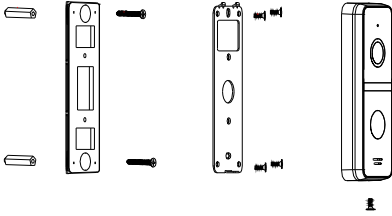

A

Surface mount

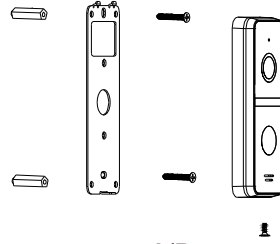

A/B

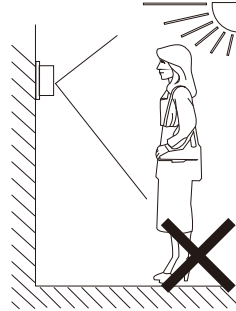
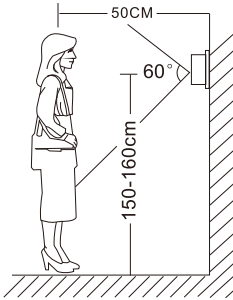

Do not install the camera directly facing towards the sun







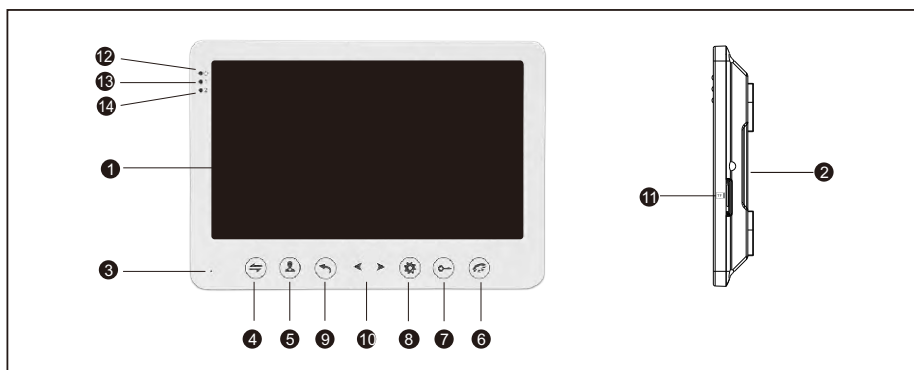

Door Speaker Volume Adjustment

To adjust the speaker volume of the door camera, remove the weather seal at the back of the door camera and adjust the regulator with a screwdriver.(refer to Door Station specification for regulator location)

NOTE: Default setting of door volume is already set as HIGH. Do not overturn the volume regulator as it can be damaged easily.

5. INDOOR MONITOR SPECIFICATIONS



NO	Name	Descriptions
1	TFT display	View visitor's image displayed on the TFT screen
2	Speaker	Sound from outdoor camera
3	Microphone	Transmit the voice to Door Station
4	Transfer/Intercom 	Call transfer/internal intercom
5	Monitoring 	Monitoring door 1 & 2
6	Talk 	Start conversation with Door Station
7	Unlock 	Unlock the door lock by pressing this button
8	Setting 	Confirm/Enter to main menu
9		Exit or Return to previous menu
10		Navigation
11	MicroSD card slot 	For the models with MicroSD card, Insert the MicroSD card for recording
12	Status LED 	Power Indicator
13	Entry LED 1	LED indicate the status of Door Station
14	Entry LED 2	LED indicate the status of Door Station

Specification	
Display screen	7" TFT LCD screen
Definition	7" (1024x600 pixels)
CCTV camera input	AHD & CVBS only
Standard	PAL
Calling mode	Two-way conversation
Calling time	120s
Standby current	Maximum 250mA
Working current	Maximum 600mA
Power supply	External switching power supply (DC 12V)
Work temperature	0~ +50°C
Mounting	Surface mount
Picture format	JPEG standard format
Extension memory (Optional)	MicroSD card (maximum 32GB)(>Class 10)
Dimension	193(L)×123(W)×21.5(D)mm
Digital Photo Frame	Yes (Displays photo from MicroSD Card). "Displays photos ..."
Custom Ringtone	Yes (Uses ringtones)
Missed Call	Missed call indicator. Clock function needs to be activated.
Motion Detection	Motion picture recording when MicroSD card installed (MicroSD card not supplied)

6.INSTALLATION OF INDOOR MONITOR

- Select the most suitable position where the monitor is located at user's eye level.

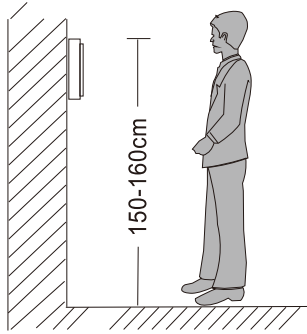

NOTE:

- Keep a distance of 30cm or more from AC power to avoid electrical interference.
 - Avoid installation of the device near strong radiation source, eg. TV, DVR, Pcs etc.
 - Do not drop, shake or knock the device to avoid damage to its components.
- To install the indoor unit , please follow these steps as below:

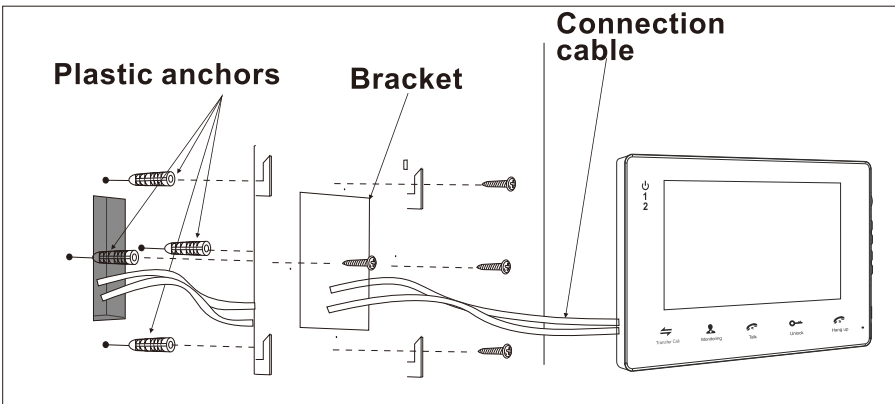

7.INSTALLATION NOTE

- i** Keep intercom wires more than 30cm away from AC mains power to avoid interference The electric lock is not included in the package, Use 12VDC electric strike only. Do not exceed 500mA.

Cable Requirements

1. CAT5e or CAT6 network cable connection mode:

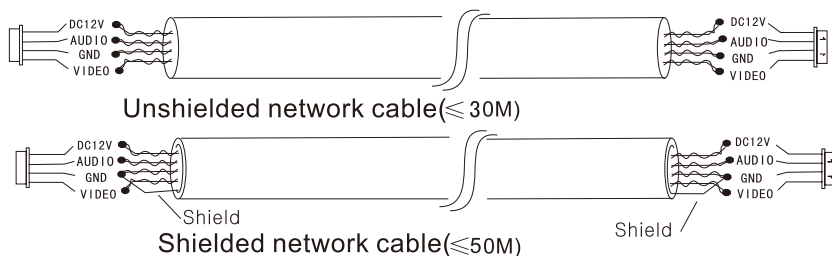

Panacom	RED	BLK	WHT	YEL
CAT5e or CAT6***	BRN, BLU	BRN/WHT, BLU/WHT GRN/WHT,ORG/WHT	GRN	ORG

*** Cable distance≤50 meters

2. 4C ordinary unshielded and shielded wire connection mode:

Distance ≤50m (4*0.5mm²)

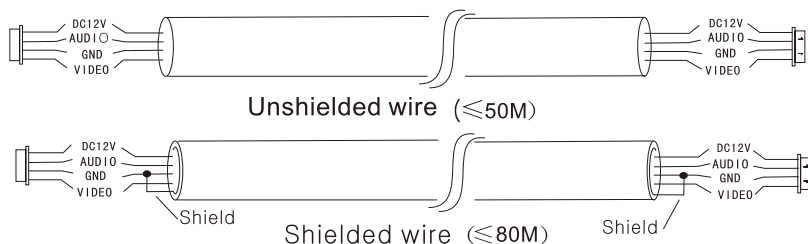

- 3.3C ordinary unshielded +75 ohm coax video wire connection mode:

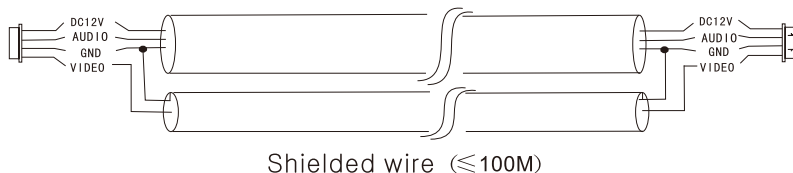

8. WIRING DIAGRAM



First monitor must be set as **MASTER**. All other monitors must be set as **SLAVE**. This can be done in the **SETTINGS** menu.

MONITOR ID SETTING
Master=01, Slave=02 to 06

Note:

HD Monitor can accept **AHD** or **CVBS** analog signals. If using HD monitor with **CVBS** analog door station, you must reboot the monitor from the menu system after connecting the camera.

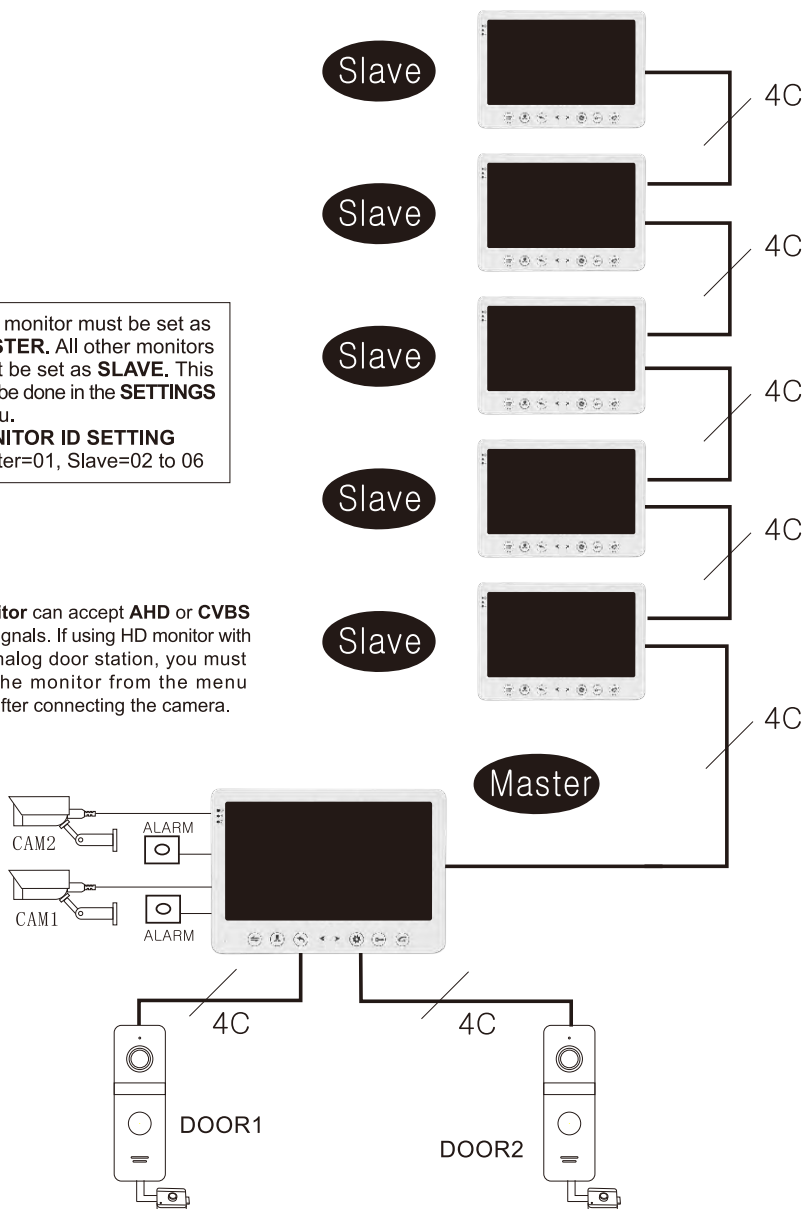

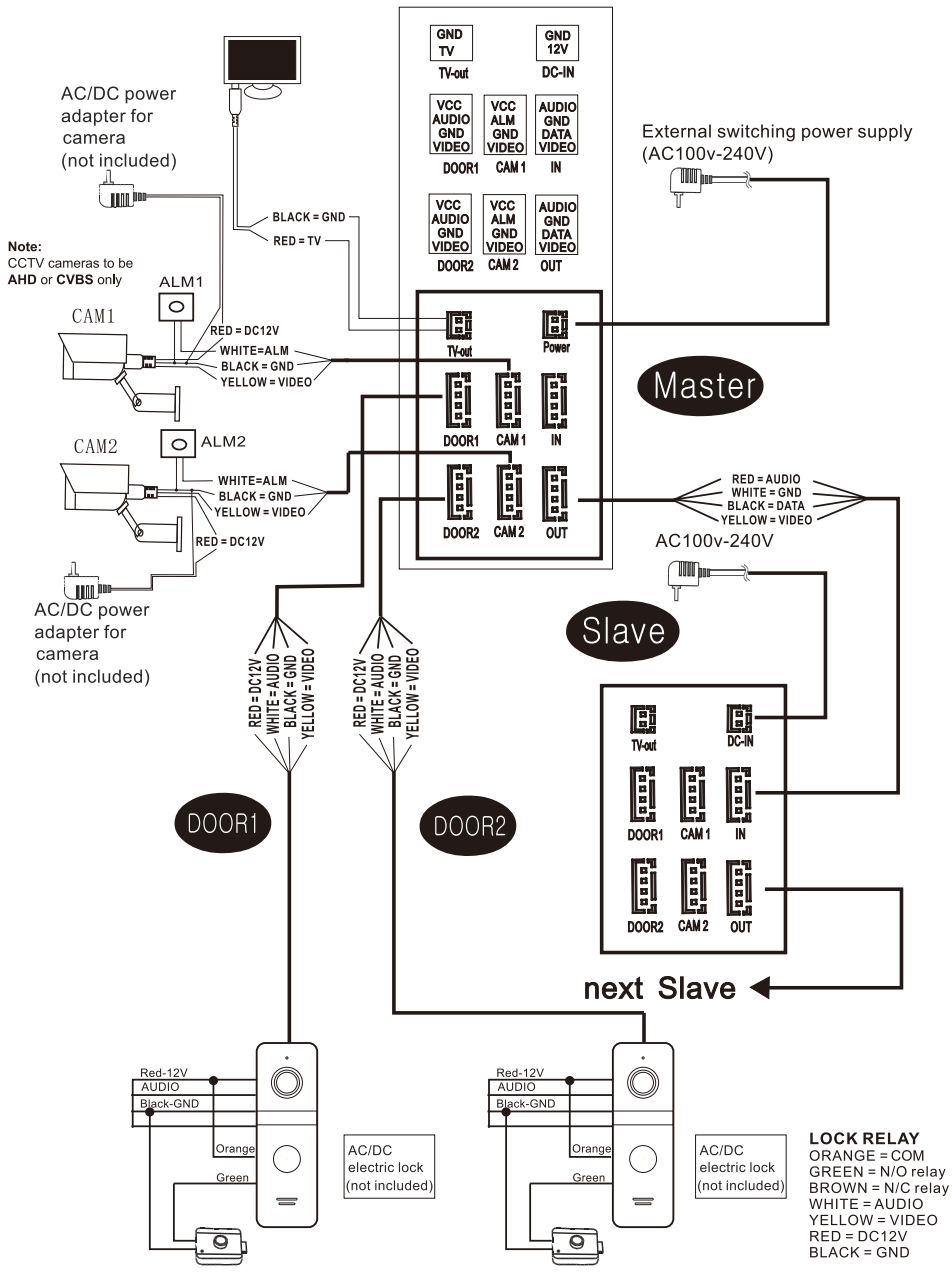

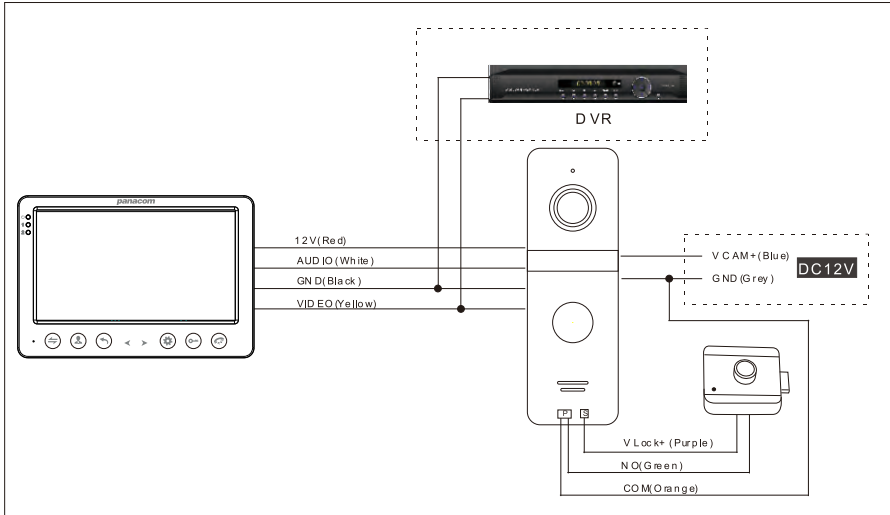

Connecting Door Camera To DVR



*Please note: an additional 12Vdc power supply (not supplied in kit) is required to constantly power the door camera for DVR connection.

9. Alarm instructions

CAM1 and CAM2 each have an alarm input. If an ALM and GND cables are shorted together, its NO-alarm will activate. The Indoor monitor will continue to ring for 120 seconds until  button is pressed. The monitor will then return to Standby mode.

For models with installed MicroSD card, an alarm will also trigger a snapshot or recording (depending on which setting is selected). The recording time is 120 seconds, or until  button is pressed. The monitor will then return to Standby mode.

Connection diagram:

 There is an alarm input for each of the two camera channels. Each alarm input can be configured to accept either a Normally Closed (NC) or Normally Open (NO) alarm inputs; or be turned OFF.

A NO-alarm input will trigger an alarm event when the ALM & GND cables are shorted together. Conversely, a NC-alarm will trigger an alarm event when the ALM & GND cables are disconnected (open circuit).

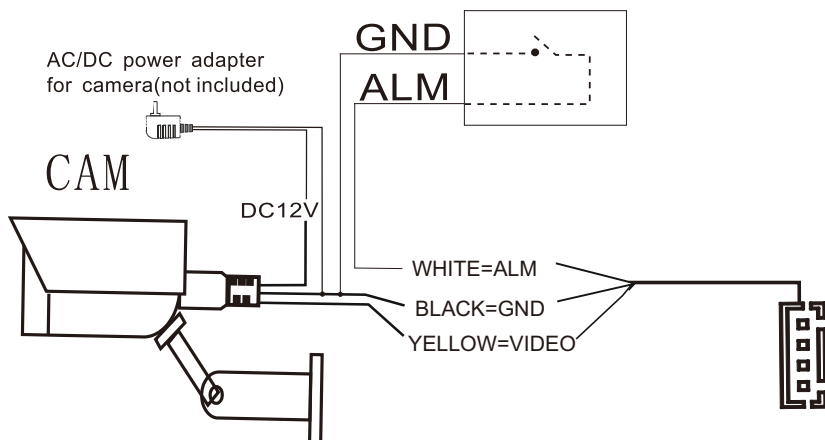

10. OPERATION INSTRUCTIONS

VISITOR CALL

Standby Mode

The visitor presses the Call button on Door Station 1 

A 10s of continuous
▼ Ding Dong tone is heard inside and outside

The visitor's image automatically displayed on the screen

▼
Press the Talk button on indoor monitor 

▼ Stop ringing

 Start conversation with Door Station

▼ The conversation duration is 120s at a time

Press the Unlock button on indoor monitor 

▶ release the door lock

The visitor presses the call button on Door Station 2 

 **Note:**









If the call buttons of both Door Stations are pressed about the same time, preference would be given to the Door Station whose call button was pressed first. Please be aware there is no indication at the second Door Station. After the indoor monitor returns to Standby Mode, it can accept calls from the second Door Station.

 **Note:**

The indoor monitor will automatically go into Standby Mode, if you are not at home, or have not answered the call within 60s.

▶ Press the hang up button on indoor monitor 

▶ End

-  The Monitor will stay active for 20 seconds for the viewer to confirm that the visitor has entered the door.
-  For models with a MicroSD card installed and Record function active: Recording will start from the beginning of a call, and can be manually stopped by pressing  Button.
-  For models with a MicroSD card installed and snapshot function active: A snapshot will be taken at the start of the call. The user can also press  button to take another snapshot manually.
-  In Monitoring mode, the monitor can listen to the door station. Press  button to begin a conversation. Press  button to unlock the door.

11. MONITORING

By default, Door1, Door2, CAM1 and CAM2 can be monitored. To disable monitoring of Door2, set "Door2 Status" to OFF in the Mode menu. To disable monitoring of CAM1 and/or CAM2, set their corresponding "CAM1" and "CAM2" switch to OFF in the Alarm menu.

Standby Mode

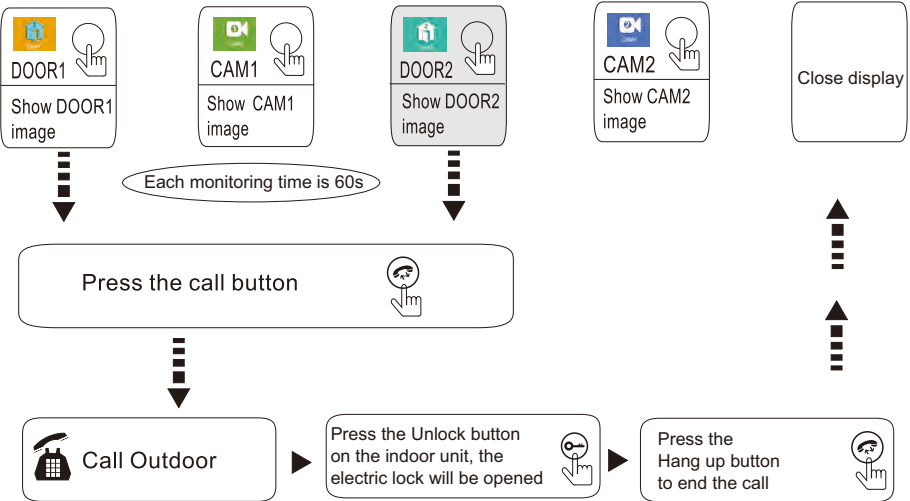

i Note:

If you are only using one Door Station, you can exit Monitoring mode by pressing the  again (when Door2, Cam1 and Cam2 have been disabled in the menu).

i If you are using two indoor units, both can simultaneously monitor the same door station. The same image will be displayed on both monitors.

i If either door station calls while the user is in Monitoring mode, the monitor will ring, exit monitoring mode and display video of the new caller.

i With an MicroSD card installed, the first press of  button will start recording (if the recording setting is active); or will take a snapshot (if the snapshot setting is active).



12. CALL TRANSFER TO OTHER EXTENSION

Internal communication function requires at least two Indoor Monitors and one Door Station to be connected.

Door Station calls indoor monitor and conversation is underway

Note:

After transferring a call to another extension, the first monitor will return to Standby mode. Whereas the target monitor will ring, and display video.

Press & hold  button to see choice of extensions to transfer the call to 

▼ The target monitor will ring

Press the Talk button of the receiving monitor to accept the incoming call 



 Talking with visitor



The Electric lock can be opened 



End the call and return to standby mode. 

13. INTERNAL COMMUNICATION AMONG INDOOR UNITS

At least 2 indoor units are required.

Standby Mode

Press & hold the "Transfer" Call button 



Select a extension which you want 

▼ The target monitor will ring

Press the Talk button of the receiving monitor to accept the incoming call 



 Start conversation among indoor units.



Press Hang up button 



End

Note:

If a visitor presses the call button of either Door Station, the Internal Communication mode will exit. The visitor's image will be displayed with ringing. Press  button to start a conversation with the visitor.

14.MENU OPERATIONS

14.1 STANDBY MODE

There are 2 mode options during standby mode: Clock and Date mode or Digital Photo Frame mode.

14.1.1 Clock and Date Mode



14.1.2 Digital Photo Frame Mode





When digital photo frame is activated, motion detection will be deactivated. The system will automatically detect pictures from MicroSD card. If no MicroSD card had been inserted, this function will not operate.



NOTED:



1. When digital photo frame function is activated, the monitor will automatically detect pictures from MicroSD card and start to play the files. Picture scroll time can be adjusted between 1-10s.
2. Using your computer, create the "USER" folder manually on the MicroSD card. Then create a "Photo" subfolder, and store your picture files for display by the Digital Photo Frame. All Music MP3 files should be put into the "\USER\Music" directory.
3. If you missed a call, a "mail" icon will be shown on the top left side of the screen during standby mode. **Note:** The clock function must be activated for this feature to operate.

14.2 MAIN MENU

While in Standby mode, press  button to open the Main menu. While in the Main menu (see below) press  &  to navigate through the menu. Press  button again to choose an item. Press  button to go back to the previous menu or Standby screen.









14.3 SET SYSTEM PARAMETERS

Navigate to the System panel using  &  buttons; and press  button to select. The System menu contains the following settings: Language, Time, Information, Ring, Volume and Return.



14.3.1 Language



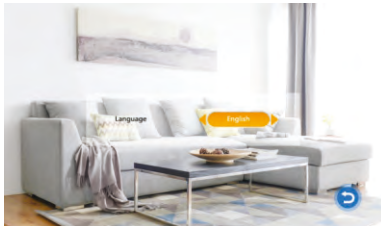

The system language can be changed. In the System menu, move cursor selection to “Language”, press  button to enter the “Language” menu. Press  button again; the arrow icons on both sides will change colour. Press  &  to change the system language. Press  button again to confirm change. Then press  button to return to previous menu.



14.3.2 Time

The Time settings adjusts the system date and time and what will be displayed in Standby mode.

The clock switch controls whether the clock is displayed in Standby mode. When turned off, the screen will be all black, without displaying neither clock nor digital photo frame display.

Use  and  &  buttons to adjust the current time. Set the display format of the clock, using the "Date Format". Once completed , press  button to return to the system menu.





14.3.3 System information

The "Information" screen shows the software version, MCU version, release date, and MicroSD card free space; plus Reboot and Format MicroSD functions.



 **Note: The product only supports the MicroSD cards that are written at a speed of more than 10MB/s with a memory of less than 32G.**

[Reboot]: Move the cursor to “” and press  button to confirm. It will pop-up a window, choose “Yes” to restart the machine, choose “No” to cancel.

[Format SD card]: Format MicroSD will remove any stored data on the inserted MicroSD card. If selected, a prompt will be displayed. To continue with formatting, select “Yes”. Otherwise, select “No” to cancel. NOTE: Formatting the MicroSD card will permanently remove any stored data on the MicroSD card. Please ensure there is nothing you want to keep before formatting.

Note: The firmware can be upgraded from a MicroSD card with a software file loaded from a PC. This function can be activated by selecting the upgrade from the media menu.



[Return]: Exit the current menu.



14.3.4 Ring

The Ringtone can be selected from either an inbuilt default ringtone, or from a custom ringtone (stored on a MicroSD card; card not supplied)



[Mode]: There are two options for ring-tones: “User Defined” and “Default”. There are 12 default ring-tones that can be selected. “User defined” will allow the user to use their own ring-tones in the “ring” folder on a MicroSD card.

[Door1]: This will change ring tone of Door 1. Use  and  &  buttons to adjust the two settings. The first line adjusts the default ring tone. The second line adjusts the user defined ring tone.

[Door2]: This will change ring tone of Door 2. Use  and  &  buttons to adjust the two settings. The first line adjusts the default ring tone. The second line adjusts the user defined ring tone.

 User defined ring-tones must be located in a folder named “ring” within the USER directory of the MicroSD card.

The system will only display the first 100 ringtone files for selection. Any additional files will not be visible.

14.3.5 Volume

Select “Volume” to adjust the ring volume of the monitor. Users can set different ring volumes for different times of day. Ring duration can be adjusted from 10s to 45s.

[Ring Vol1]: The volume level of Ring Vol1:01-10.

[Ring Vol2]: The volume level of Ring Vol2:01-10.

[Ring Vol3]: The volume level of Ring Vol3:01-10.

[Button Voice]: This option can open or close button voice.



14.4 DIGITAL PHOTO

This setting allows the monitor to cycle through images and videos inserted on the MicroSD card.

Note: Motion detection will be disabled if the Digital photo setting is active.



[Photo Frame]: Turn on or off photo frame feature.

[Interval Time]: Adjust the time between each image. Range: 01 - 10.

 All photos to be displayed by the Digital Photo frame must be stored in a subfolder named “photo” within the USER directory on the MicroSD card.

14.5 SET THE MODE OF INDOOR UNIT

Use ◀ & ▶ and  button to select “Mode”



[Mode]: Choose an ID number ranging from 01-06. An ID of “01” denotes the Master Monitor. The other IDs (“02” to “06”) denote Slave Monitors.

[Door2 status]: Enable or disable the preview of Door2.

[Door1 Unlock Time]: From 02 seconds to 10 seconds.

[Door2 Unlock Time]: From 02 seconds to 10 seconds.

[Record mode]: Options for recording Video or taking Snapshots. For "Video", when the call button of a Door Station is pressed, the Indoor Monitor with the MicroSD card will start recording video until the end of the call, or until stopped by the user. For "Snapshot", the monitor with the MicroSD card will automatically snapshot a photo. More snapshots can be manually taken by pressing  button.

[Motion Detection]: Options include "Door1", "Door2", "CAM1", "CAM2" and "Disable".

[MD Sensitivity]: Motion Detection Sensitivity can be set in three levels: Low, Medium and High. "Low" is the least sensitive trigger setting.

[MD Duration]: Indicates how long motion detection can be detected. Time can be set for 1-5minutes.

[Message]: Enable or disable message.

[Return]: Exit the current menu.

14.6 SET THE ALARM PARAMETERS

In Main Menu, move the cursor to the "Alarm" option. Then press  button to enter the Alarm menu.



[Alarm record]: Options include "Video" and "Snapshot". "Video" indicates that when an alarm is triggered, it will activate the corresponding channel to start alarm recording. "Snapshot" indicates that when an alarm is triggered, it will activate the corresponding channel to capture a picture of the current video stream as a still photo.

[CAM1 Sensor type]: CAM1 channel corresponds to an I/O status (see the following status explanations), which means that when an alarm is triggered, it will activate the corresponding channel to start alarm recording or capture a snapshot.

[CAM2 Sensor type]: CAM2 channel corresponds to an I/O status (see the following status explanations), which means that when an alarm is triggered, it will activate the corresponding channel to start alarm recording or capture a snapshot.

I/O status types:

NO: “Normally Open”, When an ALM and GND terminals is shorted, an alarm on the monitor will sound.

NC: “Normally Closed”, When an ALM and GND terminals are disconnected, an alarm on the monitor will sound.

Disable: Set the I/O to “Disable”, if external sensor alarms are not in use.

[CAM1]: Enable or disable the preview of camera1

[CAM2]: Enable or disable the preview of camera2

[CAM1 ring time]: The alarm ringing time for Camera 1, after its sensor had detected an alarm. Range from 0 - 20 seconds.

[CAM2 ring time]: The alarm ringing time for Camera 2, after its sensor had detected an alarm. Range from 0 - 20 seconds.



[Return]: Back to previous menu.

14.7 MEDIA

This menu allows you to access media files located on a MicroSD card (if inserted). These include music, movie and photo files.



14.7.1 Music (for the models with MicroSD card)

The system will automatically play from the top of the list and make its way down the list. Use the arrow keys to cycle through the audio files on the MicroSD card. Press and hold the arrow keys to fast forward and rewind the current playing track. Press  button to pause and resume play. Press  button to exit to previous menu.













While audio is playing, press  button to switch play modes. Play modes include;

- Play Once: the system will only play one selected song at a time, and auto-stop.
- Random Play: The songs will randomly play through all the songs without stopping.
- Play In Order: Plays all the songs in order from top to bottom, and auto-stops after the last song is played.
- Repeat One: Keep repeating the same song without stopping.
- Repeat All: Repeats all songs in order.



Note: If the selected play mode auto-stops, then re-open the music folder again to automatically restart playing.

14.7.2 Movie (for the models with MicroSD card)

Press  button to access the menu. Select the “Media” icon and confirm with  button. Navigate the list with  &  and select the movie you wish to play with  button. During playback, use  &  to fast forward and rewind. Press  button to pause and resume play. Press and hold  button to show the volume bar and adjust with  & . Press  button to return to the playlist.

Attention:

1. The playback will stop if an alarm is triggered or someone calls from the door station.
2. If video playback is interrupted or stopped, and if you select to play the same movie next time, you will be prompted to continue: Choose “Yes” to continue playing from where you left off. Or choose “No” to restart playback from the beginning.
3. The play-list will continue playing in a loop until it is manually stopped.

Note: Movie folder contains only video files in SD cards

- ① Store all videos in the “USER\Movie” directory on the MicroSD card, otherwise the monitor would not recognise the files.

Note: The player will only play compatible AVI, MOV and MP4 video files.



14.7.3 Photo (for the models with MicroSD card)





In the “Media” menu, select the “Photo” icon using ◀ & ▶ and pressing ⚙ button to confirm. Use ◀ & ▶ to navigate the list of Images. Press ⚙ button to select the image you would like to view. While viewing the picture, press ⚙ button to pause play. Press and hold ⚙ button to show picture information. Press ⚙ button again to play next image. Press ↶ button to return to the list.

Note: Pictures are played automatically, unless the monitor is in manual play mode.



- ① Pictures must be located in "USER\Photo" directory on the MicroSD card. Otherwise the picture would not be displayed.

14.7.4 File (for the models with MicroSD card)

The File menu (under Media menu) allows you to access all files on the MicroSD card. Press  and  &  to access the File menu, then press  button again to access the “SD” directory. You can then examine all folders on the MicroSD card. The “DCIM” folder is automatically created by the system and stores all the snapshots and video recordings. User ringtones should be stored in the “\USER\Ring” directory. Put your video & photo files in the “\USER\Movie” and “\USER\Photo” directories respectively on the MicroSD card.

Note: If there is a firmware upgrade file on the MicroSD card, it will appear as xxx.IMG. In the confirmation pop-up window, press “Yes” to upgrade, or “No” to cancel update.

Note: DO NOT remove MicroSD card or power down the system during a firmware update. The system will reboot once the update is complete.”

Note: To delete a file, press and hold  button, the system will prompt for confirmation. Select “Yes” to confirm delete or select “No” to cancel.

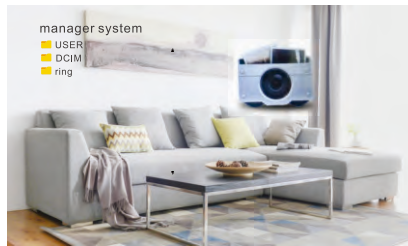

14.8 RECORD (for the models with MicroSD card)

The Record Menu allows you to play back recordings made by the system, either by motion detection or missed calls. Missed calls are indicated by the message icon on the home screen.



14.8.1 Video (for the models with MicroSD card)

Use ◀ & ▶ to navigate the stored video list, press ⚙ to select the video you would like to playback. Press ↶ button to exit current menu.

Note: Use ◀ & ▶ to navigate the stored video, press ⚙ button to select the video you would like to playback. Press ↶ button to exit current menu.



14.8.2 Picture (for the models with MicroSD card)

Use ◀ & ▶ to navigate the picture folder. Press ⚙ button to select a picture to view. Press ↶ button to exit the current menu.



Note: The Picture folder contains only photos captured by the Door Station.

i The video & photos are stored in the DCIM folder, which is automatically created by the system.

14.9 Deleting Files

Files can be deleted using the "File" submenu within the Media menu. Navigate with the arrow keys to the file you would like to delete. Then press and hold  button. The system will prompt you: Select "Yes" to confirm delete, or select "No" to cancel.

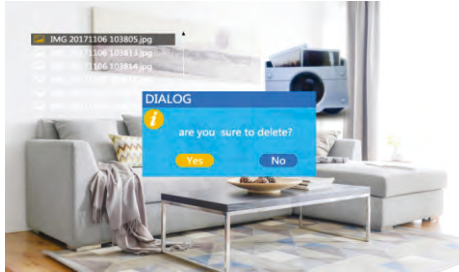

14.10 Set the color parameters

In monitoring, calling, intercom, alarm and other modes, press  button to activate the color adjustment, including volume, brightness, contrast, saturation, refresh and return.

Note: The volume slider controls the call volume.

[Bright]: Values adjustable from 0 to 50. (Default: 25).

[Contrast]: Values adjustable from 0 to 50. (Default: 25).

[Saturation]: Values adjustable from 0 to 50. (Default: 25)

[Volume]: Volume level for incoming call to indoor monitor

[Refresh]: If Monitor has registered the wrong video format for a Door Station or camera, no video would be displayed on the Monitor. Tap "" (Refresh) repeatedly to change the video signal format to match the Door Station.



15. WARRANTY & LIABILITY

- 1 PSA Products Pty Ltd (ABN: 99 076 468 703) of 17 Millicent Street, Burwood 3125 Victoria, Australia warrants this product for a period of one year from the date of purchase, as reflected on the Authorised Resellers or Distributors invoice / receipt provided to you. PSA Products Pty Ltd will repair or replace the product (at the option of PSA Products) due to any manufacturing defect, at the cost of PSA Products Pty Ltd (excluding any labour costs relating to removal or re-installation of product, and transport costs).
- 2 This warranty shall not apply to the product if it has been damaged, modified, abused or altered after the date of purchase, or if it fails to operate due to improper maintenance.
- 3 To the extent permitted by law, the liability of PSA Products Pty Ltd arising from the sale or under the terms of this limited warranty shall not in any case exceed the cost of replacement and subject to this clause. In no case shall PSA Products Pty Ltd be liable for consequential loss or damages resulting from the failure of the product or breach of this, or: Any other warranty, express or implied, loss or damage caused by failure to abide by the instructions supplied in the leaflets.
- 4 To the extent permitted by law, PSA Products Pty Ltd., makes no warranty, expressed or implied, written or oral, including that of merchantability or fitness for any particular purpose, with respect to the consumer replaceable battery if any. A product with non-serviceable built-in battery is covered under warranty of the product as per point 1.
- 5 This warranty is provided in addition to other rights and remedies you have under law: Our goods come with guarantees that cannot be excluded under the Australian Consumer Law. You are entitled to a replacement or refund for a major failure and compensation for any other reasonably foreseeable loss or damage. You are also entitled to have the goods repaired or replaced if the goods fail to be of acceptable quality and the failure does not amount to a major failure. What constitutes a major failure is set out in the Australian Consumer Law.
- 6 To make a claim under warranty, take the product (with a proof of purchase) to the store where you purchased the product or contact PSA Products Pty Ltd. Phone (03) 9888 9889. or Email: enquiry@psaproducts.com.au with details, proof of purchase or expense claim in writing.

psaproducts.com.au
1300 772 776
enquiry@psaproducts.com.au



*“Choose **PSA** for intercoms”*

FIRE • SECURITY • INTERCOMS