

This is our short form small lamp catalogue. To obtain catalogue numbers for specific lamps please refer to our price list or call us on (02) 4351 3377 for all your special lamp requirements.

## INDEX

TELEPHONE LAMPS .....	2-3
MINIATURE LAMPS .....	3-7
INDICATOR LAMPS .....	7-10
TORCH LAMPS .....	11
HALOGEN LAMPS .....	11-14
APPLIANCE LAMPS .....	15-17
SUB-MINIATURE LAMPS .....	18-22
NEON LAMPS.....	22-26
PANEL INDICATOR LED LAMPS .....	27-30
FESTOON LAMPS.....	31-33
MINIBASE & TWISTLOCK .....	33
AUTO LAMPS.....	34-37
MARINE NAVIGATION LAMPS.....	38
PILOT LAMPS .....	39-40
MISCELLANEOUS & FLUORESCENT.....	41
GLASS FUSES & FUSE HOLDERS .....	42
MULTI DIRECTIONAL LED LAMPS .....	43-50
LAMP SOCKETS & ACCESSORIES .....	51-54
ELECTRICAL CHARACTERISTICS .....	55-57

*To ensure that the vital link of visual indication is properly maintained, the lamps selected by Associated Switchgear are manufactured to 1st quality standards.*

For specifications, price and availability call...

Phone: (02) 4351 3377

**ASI Lamps**

Fax: (02) 4351 6627

# TELEPHONE LAMPS

DEPICTED IN ACTUAL SIZE

01

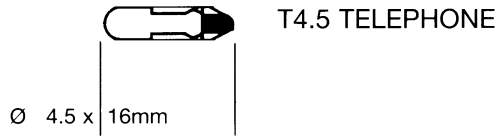

02

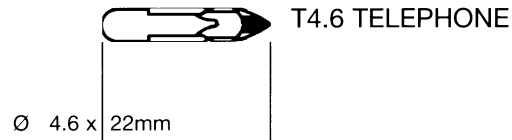

03

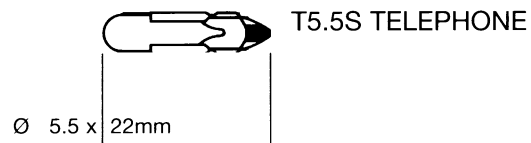

04

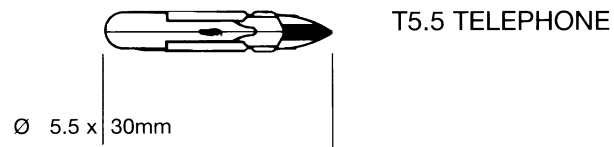

05

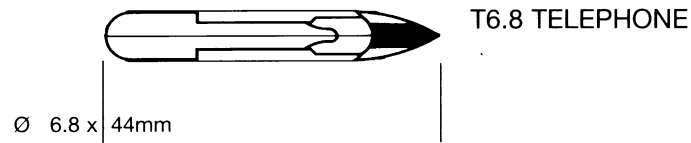

06

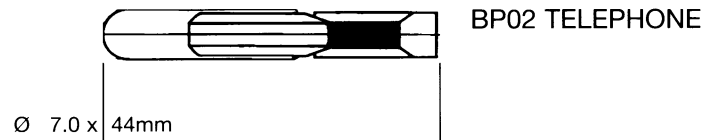

For specifications, price and availability call...

Phone: (02) 4351 3377

*ASI Lamps*

Fax: (02) 4351 6627

## TELEPHONE LAMPS – cont.

DEPICTED IN ACTUAL SIZE

07

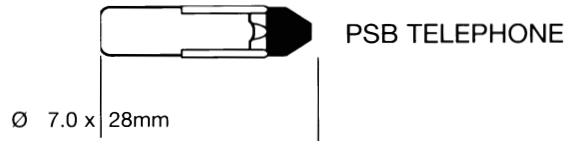

08

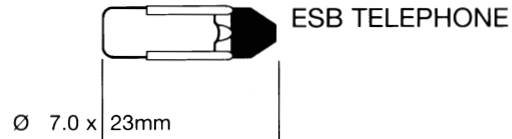

09

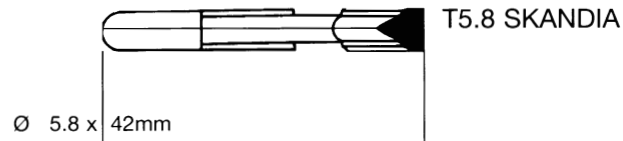

## MINIATURE LAMPS

DEPICTED IN ACTUAL SIZE

10

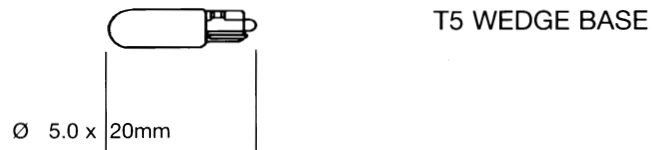

11



For specifications, price and availability call...

Phone: (02) 4351 3377

*ASI Lamps*

Fax: (02) 4351 6627

# MINIATURE LAMPS – cont.

DEPICTED IN ACTUAL SIZE

12

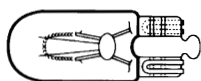

T10 WEDGE BASE

Ø 10 x 26mm

13

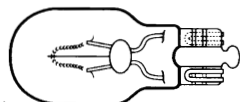

T13 WEDGE BASE

Ø 13 x 31mm

14

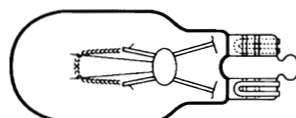

T16 WEDGE BASE

Ø 16 x 38mm

15



MINIATURE 2-PIN

Ø 12 x 24mm

16

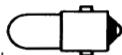

BA5S BASE

Ø 5.0 x 16mm

17

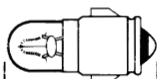

BA7S BASE

Ø 6.8 x 20mm

For specifications, price and availability call...

Phone: (02) 4351 3377

*ASI Lamps*

Fax: (02) 4351 6627

# MINIATURE LAMPS – cont.

DEPICTED IN ACTUAL SIZE

18

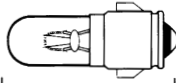

Ø 6.8 x 23mm

BA7S BASE

19

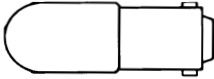

Ø 10 x 28mm

BA9S BASE (MBC)  
(Long Life also available)

20



Ø 9.0 x 23mm

BA9S BASE

21

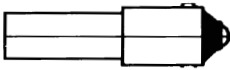

Ø 8.5 x 30mm

BA9S (MB SERIES)

22

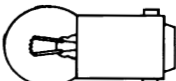

Ø 11 x 23mm

BA9S G11

23

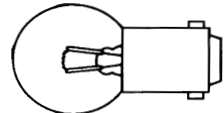

Ø 15 x 28mm

BA9S G15

For specifications, price and availability call...

Phone: (02) 4351 3377

*ASI Lamps*

Fax: (02) 4351 6627

# MINIATURE LAMPS – cont.

DEPICTED IN ACTUAL SIZE

24

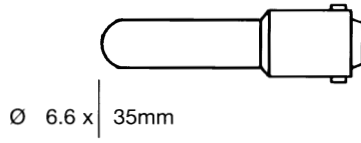

BA9S TELEWRITER

Ø 6.6 x 35mm

25

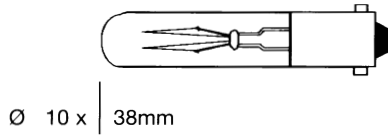

BA9S BASE

Ø 10 x 38mm

26

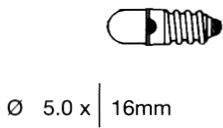

E5 BASE

Ø 5.0 x 16mm

27

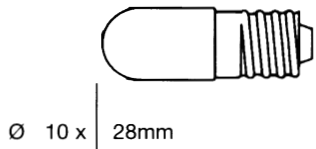

E10 BASE

Ø 10 x 28mm

28

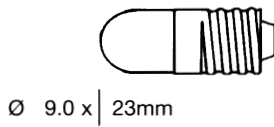

E10 BASE

Ø 9.0 x 23mm

29

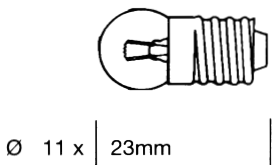

E10 G11

Ø 11 x 23mm

For specifications, price and availability call...

Phone: (02) 4351 3377

*ASI Lamps*

Fax: (02) 4351 6627

## MINIATURE LAMPS – cont.

DEPICTED IN ACTUAL SIZE

**30**

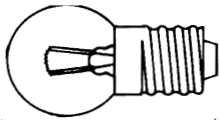

E10 G15

Ø 15 x 28mm

**31**

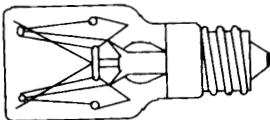

E10 BASE

Ø 16 x 35mm

**32**

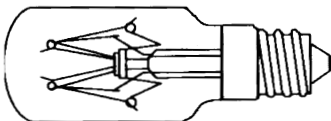

E10 BASE

Ø 16 x 43mm

**33**

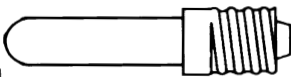

E10 TELEWRITER

Ø 6.6 x 38mm

## INDICATOR LAMPS

DEPICTED IN ACTUAL SIZE

**34**

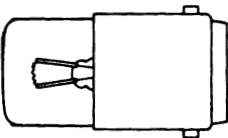

BA15D BASE (SBC)

Ø 13 x 30mm

For specifications, price and availability call...

Phone: (02) 4351 3377

*ASI Lamps*

Fax: (02) 4351 6627

# INDICATOR LAMPS – cont.

DEPICTED IN ACTUAL SIZE

**35**

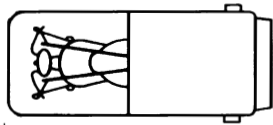

Ø 16 x 35mm

BA15D

**36**

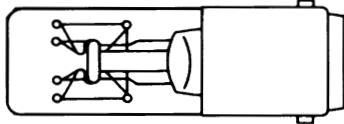

Ø 16 x 45mm

BA15D

**37**

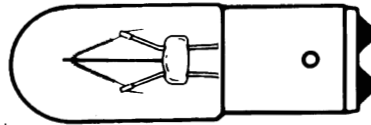

Ø 16 x 48mm

BA15D

**38**

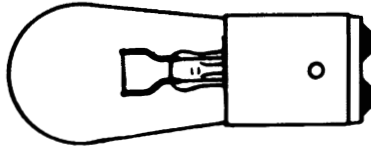

Ø ST19 x 48mm

BA15D 6S6

**39**

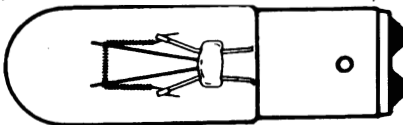

Ø 16 x 53mm

BA15D

**40**

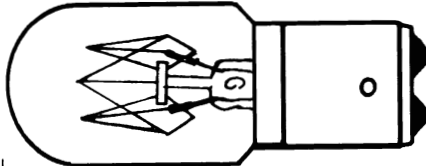

Ø 22 x 56mm

BA15D

For specifications, price and availability call...

Phone: (02) 4351 3377

*ASI Lamps*

Fax: (02) 4351 6627



# INDICATOR LAMPS - cont.

DEPICTED IN ACTUAL SIZE

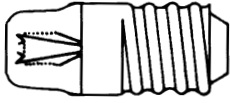
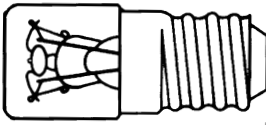
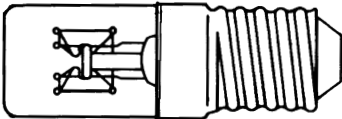
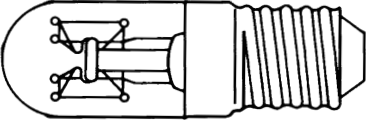
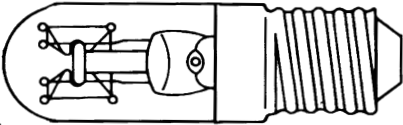
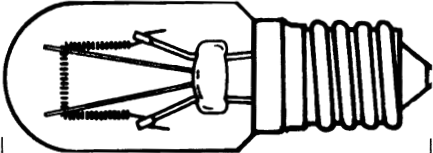
<b>41</b>		E14 BASE (SES)
	Ø 13 x 30mm	
<b>42</b>		E14
	Ø 16 x 35mm	
<b>43</b>		E14
	Ø 16 x 45mm	
<b>44</b>		E14
	Ø 16 x 48mm	
<b>45</b>		E14
	Ø 16 x 53mm	
<b>46</b>		E14
	Ø 22 x 56mm	

For specifications, price and availability call...

Phone: (02) 4351 3377

*ASI Lamps*

Fax: (02) 4351 6627

# INDICATOR LAMPS - cont.

DEPICTED IN ACTUAL SIZE

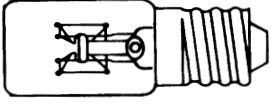
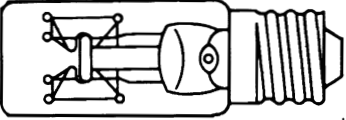
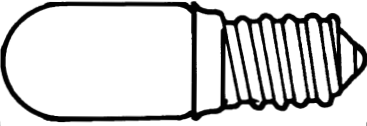
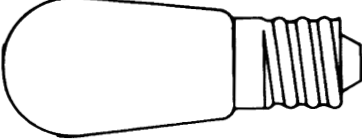
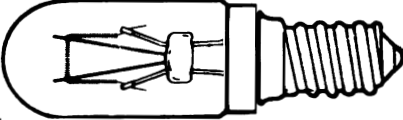
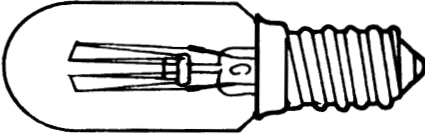
<b>47</b>		E12 BASE
	Ø 13 x 35mm	
<b>48</b>		E12
	Ø 16 x 45mm	
<b>49</b>		E12
	Ø 16 x 48mm	
<b>50</b>		E12 6S6
	Ø ST19 x 48mm	
<b>51</b>		E12
	Ø 16 x 53mm	
<b>52</b>		E12
	Ø 22 x 56mm	

For specifications, price and availability call...

Phone: (02) 4351 3377

*ASI Lamps*

Fax: (02) 4351 6627

## TORCH LAMPS

DEPICTED IN ACTUAL SIZE

53



E10 BASE

Ø 10 x 24mm

54

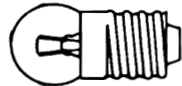

E10

Ø 11 x 23mm

55

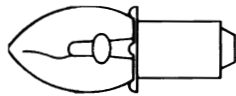

P13.5S BASE PRE FOCUS

Ø 11.5 x 30mm

## HALOGEN LAMPS

DEPICTED IN ACTUAL SIZE

56

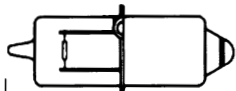

P13.5S

Ø 10 x 30mm

57

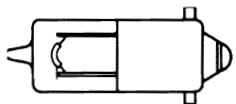

BA9S

Ø 10 x 30mm

For specifications, price and availability call...

Phone: (02) 4351 3377

*ASI Lamps*

Fax: (02) 4351 6627

# HALOGEN LAMPS – cont.

DEPICTED IN ACTUAL SIZE

58



E10

Ø 10 x 28mm

59

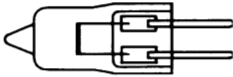

G4 BASE

Ø 9.0 x 30mm

60

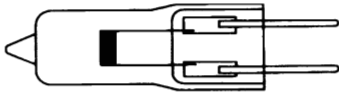

G6.35 BASE

Ø 11 x 44mm

61

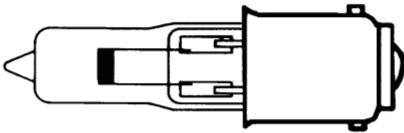

BA15S

Ø 15 x 53mm

62

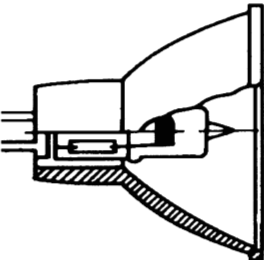

GU4 BASE MR11

Ø 35 x 35mm

For specifications, price and availability call...

Phone: (02) 4351 3377

*ASI Lamps*

Fax: (02) 4351 6627

# HALOGEN LAMPS – cont.

DEPICTED IN ACTUAL SIZE

63

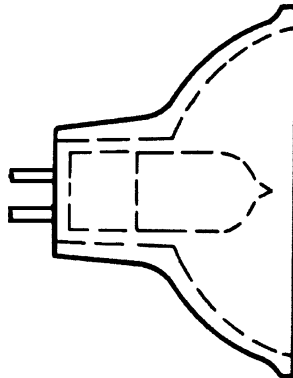

G5.3 BASE MR16

Ø 50 x 44mm

64

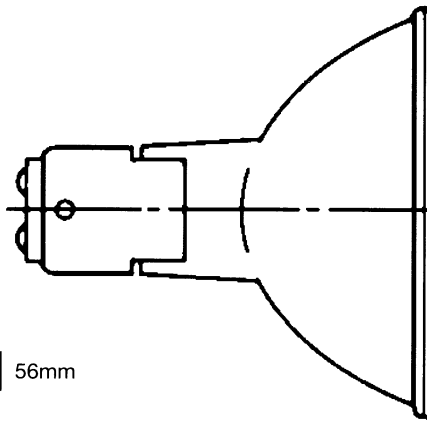

BA15D BASE

Ø 56 x 56mm

65

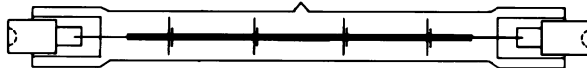

R7S BASE

LINEAR FLOODLIGHTS — REFER TO ASSOCIATED SWITCHGEAR

For specifications, price and availability call...

Phone: (02) 4351 3377

*ASI Lamps*

Fax: (02) 4351 6627

# HALOGEN LAMPS – cont.

DEPICTED IN ACTUAL SIZE

66

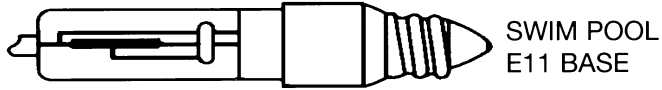

SWIM POOL  
E11 BASE

Ø 12 x | 65mm

67

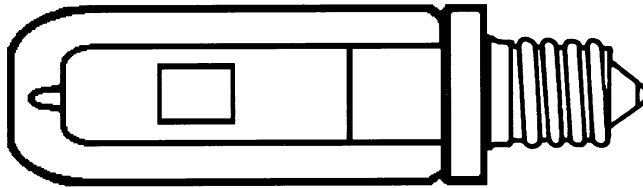

DOUBLE GLASS — E14

Ø 31 x | 85mm

DOUBLE GLASS — E27

68

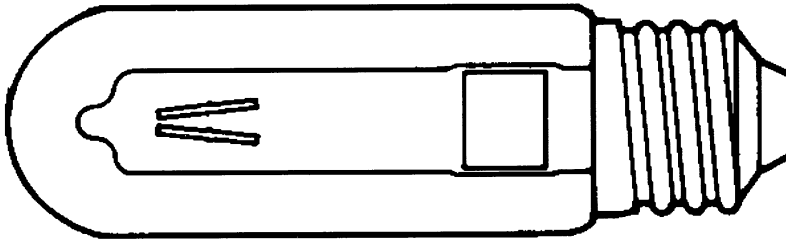

Ø 32 x | 105mm

For specifications, price and availability call...

Phone: (02) 4351 3377

*ASI Lamps*

Fax: (02) 4351 6627

# APPLIANCE LAMPS

DEPICTED IN ACTUAL SIZE

69

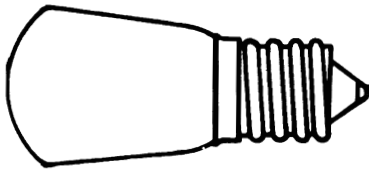

300°C  
E14 OVEN

Ø P22 x 48mm

70

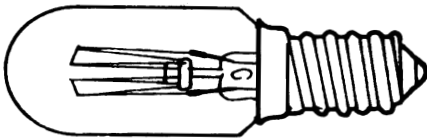

E12  
MICROWAVE

Ø 22 x 56mm

71

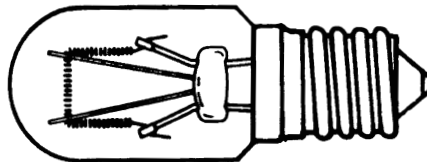

E14  
FRIDGE  
MICROWAVE

Ø 22 x 56mm

72

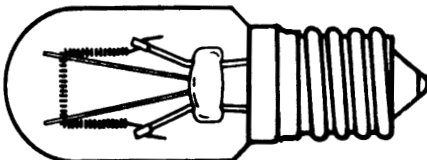

E17  
MICROWAVE

Ø 22 x 56mm

For specifications, price and availability call...

Phone: (02) 4351 3377

*ASI Lamps*

Fax: (02) 4351 6627

# APPLIANCE LAMPS – cont.

DEPICTED IN ACTUAL SIZE

**73**

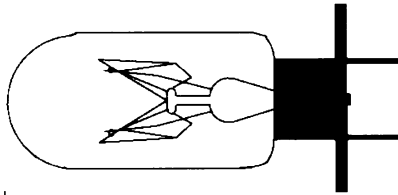

SPADE TERMINALS  
FOR MICROWAVE

Ø 25 x 52mm

**74**

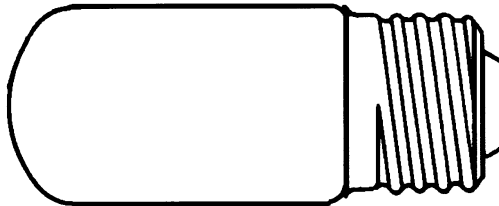

300°C  
E27 OVEN

Ø 28 x 65mm

**75**

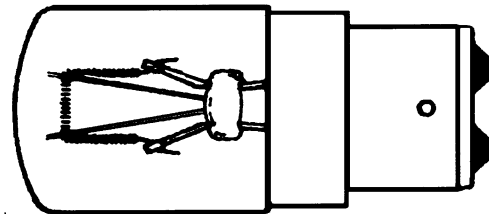

300°C  
B22 OVEN

Ø 28 x 65mm

**76**

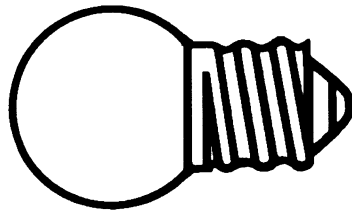

300°C  
E27 OVEN

Ø 45 x 70mm

NOT TO SCALE

For specifications, price and availability call...

Phone: (02) 4351 3377

*ASI Lamps*

Fax: (02) 4351 6627



# APPLIANCE LAMPS – cont.

DEPICTED IN ACTUAL SIZE

**77**

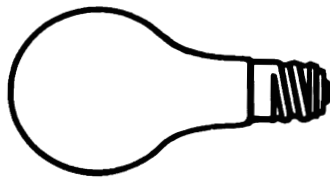

300°C  
E27 OVEN

NOT TO SCALE

Ø A 60 x 103mm

**78**

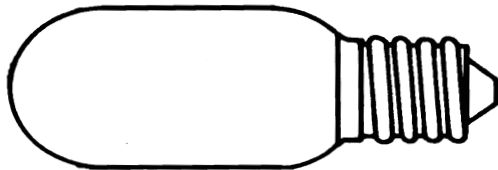

E14  
SEWING  
MACHINE

Ø 22 x 65mm

**79**

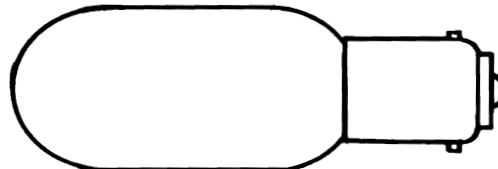

BA15D  
SEWING  
MACHINE

Ø 22 x 65mm

**80**

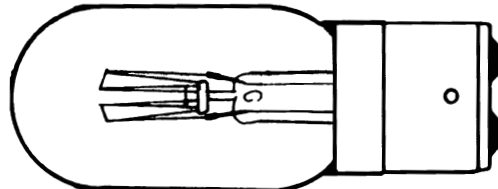

B22  
SEWING  
MACHINE

Ø 25 x 65mm

For specifications, price and availability call...

Phone: (02) 4351 3377

*ASI Lamps*

Fax: (02) 4351 6627

# SUB-MINIATURE LAMPS

DEPICTED IN ACTUAL SIZE

81

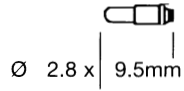

T<sup>3</sup>/<sub>4</sub> FLANGE TYPES

82

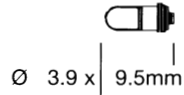

T1 FLANGE

83

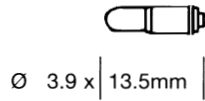

T1 (LONG) FLANGE

84

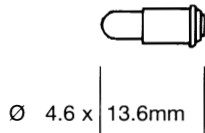

T<sup>1</sup>/<sub>4</sub> FLANGE

85

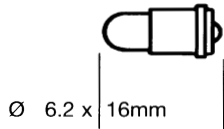

T<sup>1</sup>/<sub>4</sub> FLANGE

86

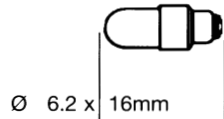

T<sup>1</sup>/<sub>4</sub> STEP BASE

For specifications, price and availability call...

Phone: (02) 4351 3377

*ASI Lamps*

Fax: (02) 4351 6627

# SUB-MINIATURE LAMPS – cont.

DEPICTED IN ACTUAL SIZE

87

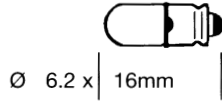

T<sup>13/4</sup> MIDGET GROOVE

88

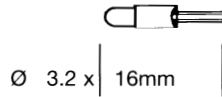

T1 B1 PIN

89

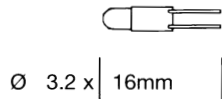

T1 (E) B1 PIN

90

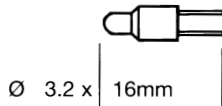

T1 B1 PIN

91

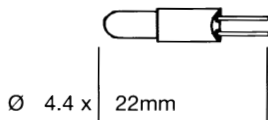

T<sup>11/4</sup> B1 PIN

92

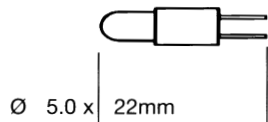

T<sup>11/2</sup> B1 PIN

For specifications, price and availability call...

Phone: (02) 4351 3377

*ASI Lamps*

Fax: (02) 4351 6627

# SUB-MINIATURE LAMPS – cont.

DEPICTED IN ACTUAL SIZE

93

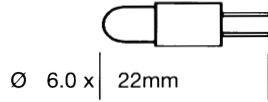

T1<sup>3</sup>/<sub>4</sub> B1 PIN

94

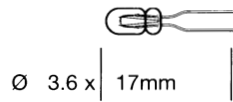

T1 GLASS B1 PIN

95

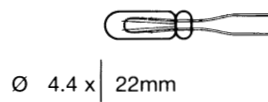

T1<sup>1</sup>/<sub>4</sub> GLASS B1 PIN

96

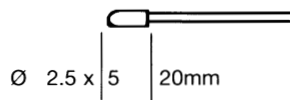

T<sup>3</sup>/<sub>4</sub> WIRE TAIL

97

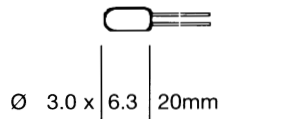

T1 WIRE TAIL

98

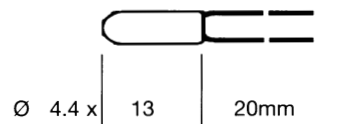

T1<sup>1</sup>/<sub>4</sub> WIRE TAIL

For specifications, price and availability call...

Phone: (02) 4351 3377

*ASI Lamps*

Fax: (02) 4351 6627

# SUB-MINIATURE LAMPS – cont.

DEPICTED IN ACTUAL SIZE

99

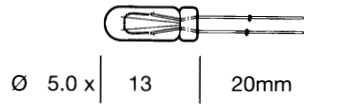

T1<sup>1</sup>/<sub>2</sub> WIRE TAIL

100

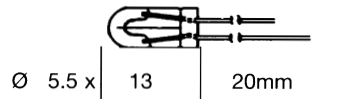

T1<sup>3</sup>/<sub>4</sub> WIRE TAIL

101

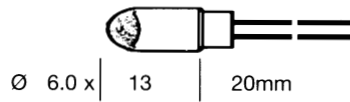

TL<sup>13</sup>/<sub>4</sub> LENS END  
WIRE TAIL

102

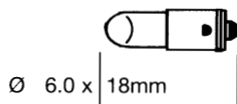

TL<sup>13</sup>/<sub>4</sub> M FLANGE LENS END

103

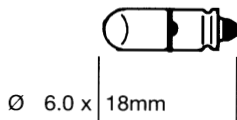

TL<sup>13</sup>/<sub>4</sub> M GROOVE LENS END

104

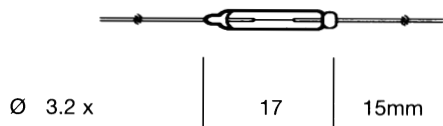

AXIAL T1

For specifications, price and availability call...

Phone: (02) 4351 3377

*ASI Lamps*

Fax: (02) 4351 6627

# SUB-MINIATURE LAMPS – cont.

DEPICTED IN ACTUAL SIZE

105

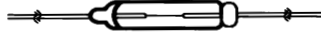

AXIAL T1<sup>1/4</sup>

Ø 4.3 x | 20 | 15mm |

106

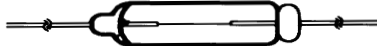

AXIAL T2

Ø 6.0 x | 28 | 15mm |

107

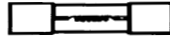

FUSE LAMP  
2AG

Ø 5.0 x | 22mm |

108

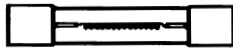

FUSE LAMP  
3AG

Ø 6.3 x | 30mm |

# NEON LAMPS

DEPICTED IN ACTUAL SIZE

109



WIRE TAIL

Ø 4.0 x | 10 | 23mm |

For specifications, price and availability call...

Phone: (02) 4351 3377

*ASI Lamps*

Fax: (02) 4351 6627

# NEON LAMPS – cont.

DEPICTED IN ACTUAL SIZE

110

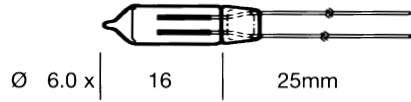

WIRE TAIL

111

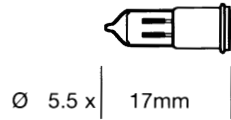

T13/4 M FLANGE

112

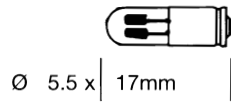

T13/4 M GROOVE

113

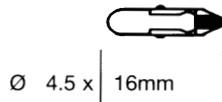

T4.5 TELEPHONE

114



T4.6 TELEPHONE

115

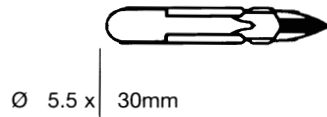

T5.5 TELEPHONE

For specifications, price and availability call...

Phone: (02) 4351 3377

*ASI Lamps*

Fax: (02) 4351 6627

# NEON LAMPS – cont.

DEPICTED IN ACTUAL SIZE

116

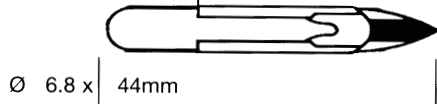

T6.8 TELEPHONE

117

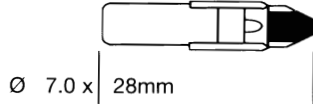

PSB TELEPHONE

118

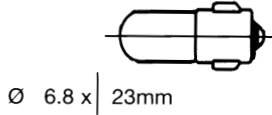

BA7S BAYONET BASE

119

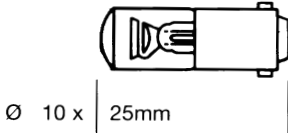

BA9S BAYONET BASE

120

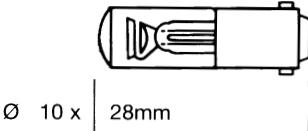

BA9S BAYONET BASE

121

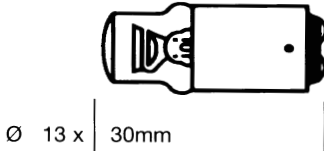

BA15D BAYONET BASE

For specifications, price and availability call...

Phone: (02) 4351 3377

*ASI Lamps*

Fax: (02) 4351 6627



# NEON LAMPS - cont.

DEPICTED IN ACTUAL SIZE

122

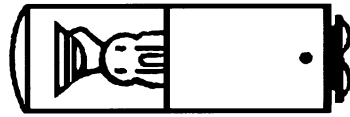

BA15D  
BAYONET BASE

Ø 15 x 45mm

123

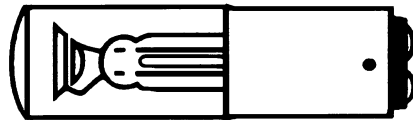

BA15D  
BAYONET BASE

Ø 16 x 54mm

124

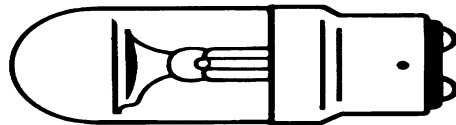

B22  
BAYONET BASE

Ø 25 x 60mm

NOT TO SCALE

125

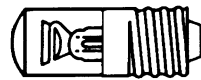

E10 SCREW BASE

Ø 10 x 25mm

126



E10 SCREW BASE

Ø 10 x 28mm

127



E12 SCREW BASE

Ø 13 x 35mm

For specifications, price and availability call...

Phone: (02) 4351 3377

*ASI Lamps*

Fax: (02) 4351 6627

# NEON LAMPS – cont.

DEPICTED IN ACTUAL SIZE

**128**

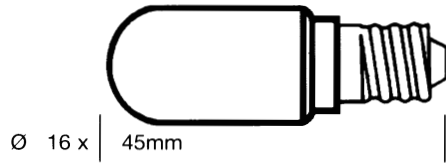

E12 SCREW BASE

**129**

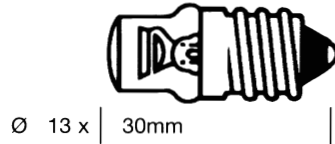

E14 SCREW BASE

**130**

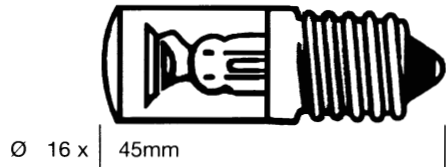

E14 SCREW BASE

**131**

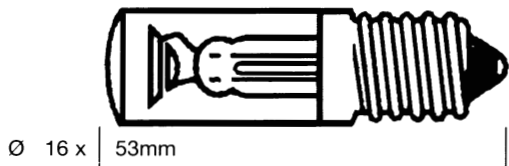

E14 SCREW BASE

**132**

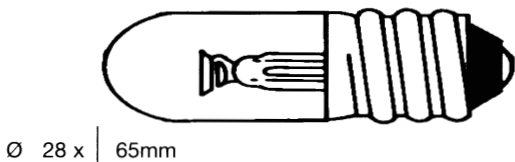

E27 SCREW BASE

NOT TO SCALE

For specifications, price and availability call...

Phone: (02) 4351 3377

*ASI Lamps*

Fax: (02) 4351 6627

# PANEL INDICATORS LED LAMPS

DEPICTED IN ACTUAL SIZE

**133**

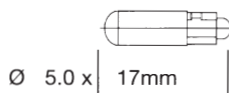

T5 WEDGE BASE

**134**

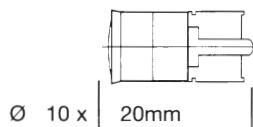

T10 WEDGE BASE

**135**

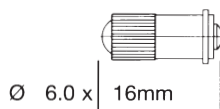

T $1\frac{3}{4}$  M FLANGE

**135A**



P13.55 TORCH 7 CHIP

**136**

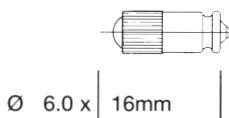

T $1\frac{3}{4}$  M GROOVE

**137**

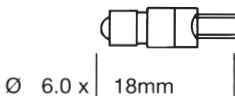

T $1\frac{3}{4}$  B1 PIN

**138**

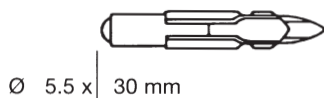

T5.5 TELEPHONE

**139**

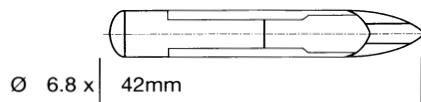

T6.8 TELEPHONE

**140**



BA7S BAYONET BASE

**141**

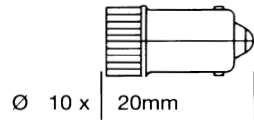

BA9S 8 CHIP  
BAYONET BASE

**141T**



BA9S 3 CHIP

**142**

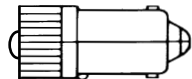

BA9S 8 CHIP  
BAYONET BASE

**142A**

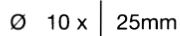

BA9S 1 CHIP

**143**

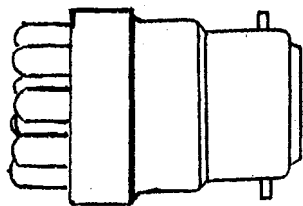

B22 12 CHIP  
BAYONET BASE

**143A**

B22 24 CHIP  
BAYONET BASE

**143T**

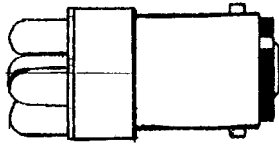

BA15D 6 CHIP

**143S**

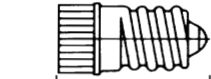

BA15S 6 CHIP

**144**

Ø 10 x 20mm

E10 8 CHIP  
SCREW BASE

**145**

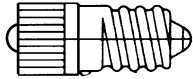

E10 8 CHIP  
SCREW BASE

**145A**

Ø 10 x 25mm

E10 1 CHIP

**145T**

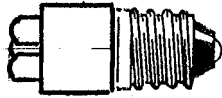

E10 3 CHIP

**146**



E12 6 CHIP  
SCREW BASE

**147**

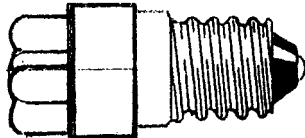

E14 6 CHIP  
SCREW BASE

**147A**

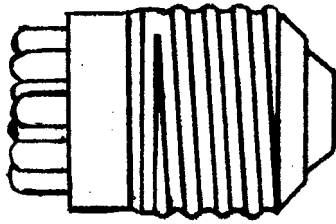

E27 12 CHIP

**147B**

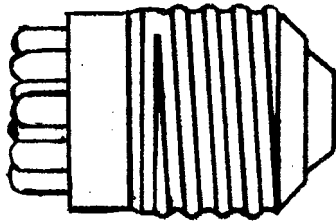

E27 24 CHIP

**148**

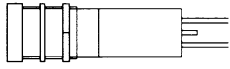

LED INDICATORS

Ø 8.0 x 29mm

**149**

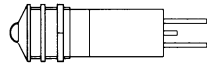

LED INDICATORS

Ø 8.0 x 26mm

**150**

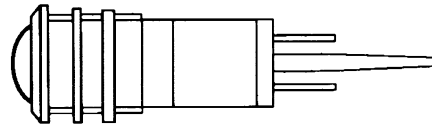

LED INDICATORS

NOT TO SCALE

Ø 16 x 56mm

**150A**

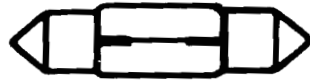

FESTOON LED  
Other sizes Available

**TO CREATE A PART NUMBER:**

- 1) Select the Cat No. of the Base type required.
- 2) Add the Voltage Required.
- 3) Nominate the colour required.

**Example:** If lamp required is a BA9S 240V Red, the part number will be: 141T-240/RED.

**Prices:** Are trade price for all voltages up to 240V, exclusive of GST.

**TYPICAL SPECIFICATIONS FOR 24V AC/DC (BA9S):**

Emitting Colour	Operate Volts	Wave Length NM @ If 200mA	Forward I @ Vin (mA)	Luminous Intensity @ Vin (MCD) MIN / TYPICAL
RED	24	628 30	20mA	15000 / 21000
YELLOW	24	588 30	20mA	15000 / 21000
GREEN	24	525 30	20mA	12000 / 17000
BLUE	24	470 30	20mA	3000 / 4500
WHITE	24	x0.31 y0.32	20mA	7200 / 10000

**30**

\* Based on 3x3 LED Per BA9S Lamp.

# FESTOON LAMPS

DEPICTED IN ACTUAL SIZE

**151**

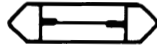

Ø 6.0 x 24mm

**152**

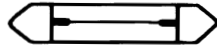

Ø 6.0 x 28mm

**153**

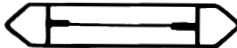

Ø 6.0 x 31mm

**154**

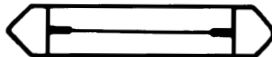

Ø 6.0 x 36mm

**155**

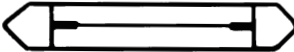

Ø 6.0 x 39mm

**156**

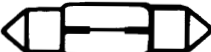

Ø 8.0 x 28mm

For specifications, price and availability call...

Phone: (02) 4351 3377

*ASI Lamps*

Fax: (02) 4351 6627

# FESTOON LAMPS – cont.

DEPICTED IN ACTUAL SIZE

157

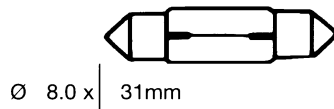

158

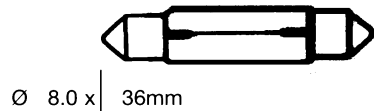

159

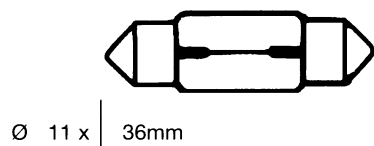

160

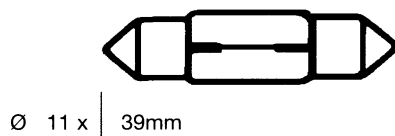

161

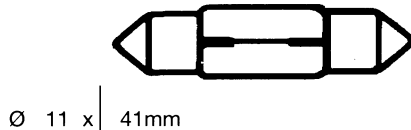

For specifications, price and availability call...

Phone: (02) 4351 3377

*ASI Lamps*

Fax: (02) 4351 6627



# FESTOON & TWISTLOCK LAMPS

DEPICTED IN ACTUAL SIZE

162

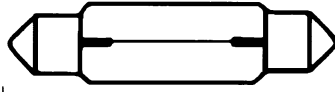

Ø 11 x 44mm

163

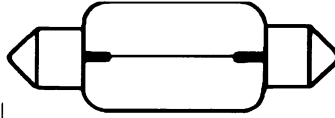

Ø 15 x 44mm

164



Ø 3.0 x 9mm

T1 MINIBASE

165

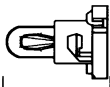

Ø 4.7 x 14mm

T1<sup>1/4</sup> MINIBASE

166

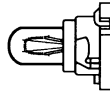

Ø 4.8 x 14.5mm

T1<sup>1/2</sup> MINIBASE

167

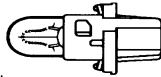

Ø 9.8 x 21mm

T1<sup>1/2</sup> TWISTLOCK

168

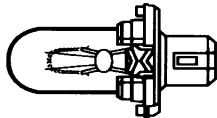

Ø 10 x 28mm

T3<sup>1/4</sup> TWISTLOCK

For specifications, price and availability call...

Phone: (02) 4351 3377

*ASI Lamps*

Fax: (02) 4351 6627

# AUTO LAMPS

DEPICTED IN ACTUAL SIZE

HALOGEN TYPES

169

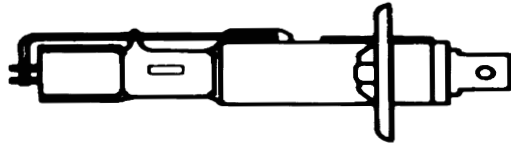

H1

Ø 10 x 67mm

170

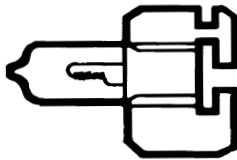

H2

Ø 9.0 x 31mm

171

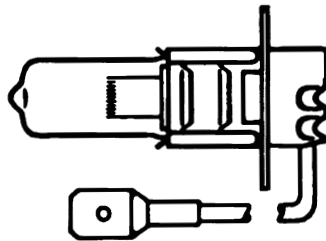

H3

Ø 11 x 41mm

For specifications, price and availability call...

Phone: (02) 4351 3377

*ASI Lamps*

Fax: (02) 4351 6627

# AUTO LAMPS – cont.

DEPICTED IN ACTUAL SIZE

172

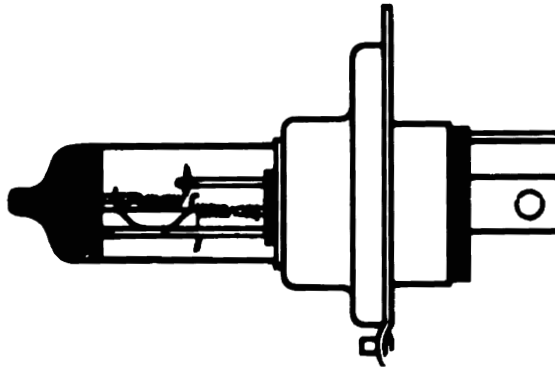

P43T  
H4

Ø 17 x 73mm

173

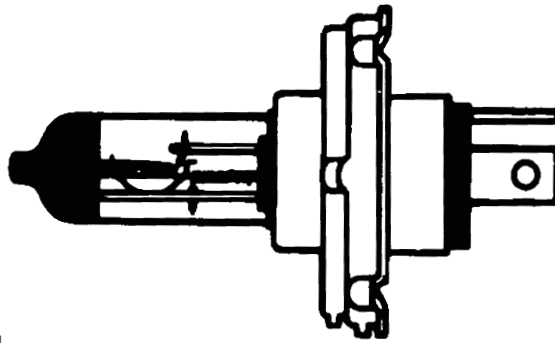

P45T  
H4

Ø 17 x 73mm

174

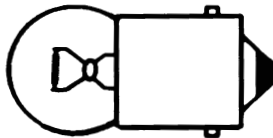

BA15S  
G18

Ø 18 x 36mm

For specifications, price and availability call...

Phone: (02) 4351 3377

*ASI Lamps*

Fax: (02) 4351 6627

# AUTO LAMPS - cont.

DEPICTED IN ACTUAL SIZE

175

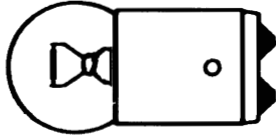

Ø 18 x | 36mm

BA15D G18

176

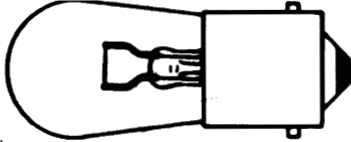

Ø 19 x | 46mm

BA15S

177

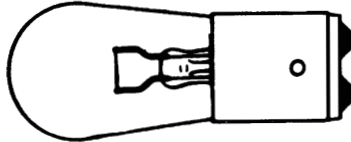

Ø P19 x | 46mm

BA15D

178

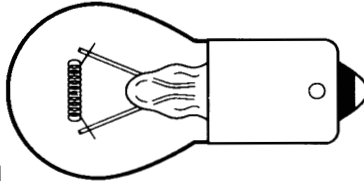

Ø G25 x | 48mm

BA15S G25

179

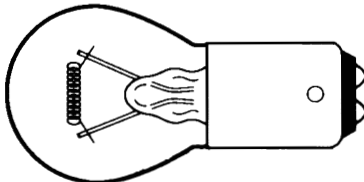

Ø G25 x | 48mm

BA15D G25

For specifications, price and availability call...

Phone: (02) 4351 3377

*ASI Lamps*

Fax: (02) 4351 6627

# AUTO LAMPS – cont.

DEPICTED IN ACTUAL SIZE

180

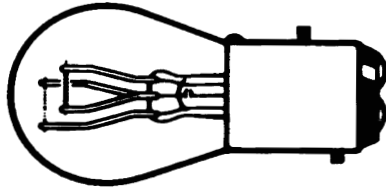

STOP/TAIL  
BAY15D

Ø G25 x 50mm

181

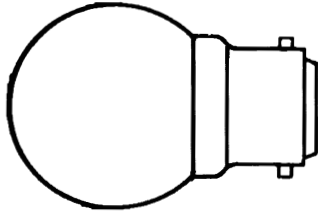

BUS LAMP  
B22

NOT TO SCALE

Ø G40 x 60mm

182

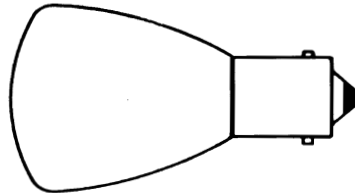

FLASHING BEACON  
BA15S

NOT TO SCALE

Ø RP35 x 54mm

183

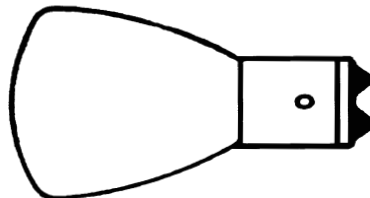

FLASHING BEACON  
BA15D

NOT TO SCALE

Ø RP35 x 54mm

For specifications, price and availability call...

Phone: (02) 4351 3377

*ASI Lamps*

Fax: (02) 4351 6627

# NAVIGATION LAMPS

DEPICTED IN ACTUAL SIZE

184

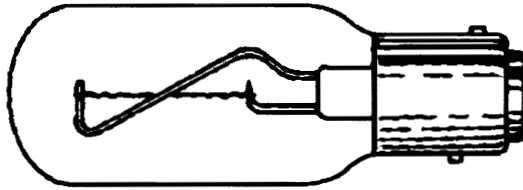

BAY15D

Ø 25 x 70mm

185

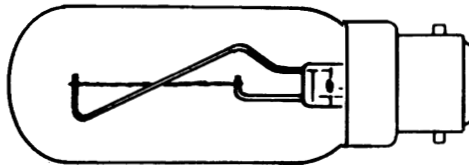

B22 (BC)

NOT TO SCALE

Ø 38 x 103mm

186

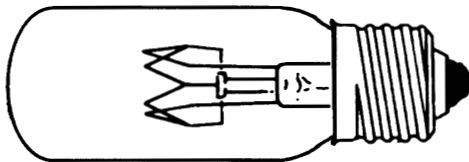

E27 (ES)

NOT TO SCALE

Ø 38 x 103mm

187

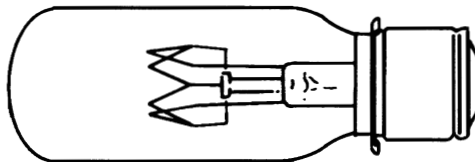

P28S

NOT TO SCALE

Ø 38 x 103mm

For specifications, price and availability call...

Phone: (02) 4351 3377

*ASI Lamps*

Fax: (02) 4351 6627

# PILOT LAMPS

DEPICTED IN ACTUAL SIZE

188

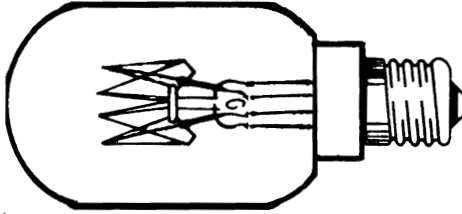

E12 BASE  
(CES)

Ø 28 x 60mm

189

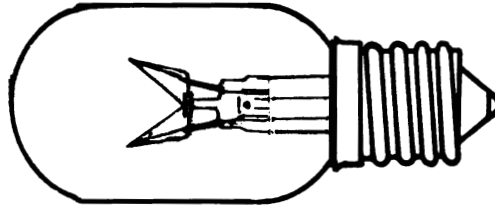

E14 BASE  
(SES)

Ø 28 x 65mm

190

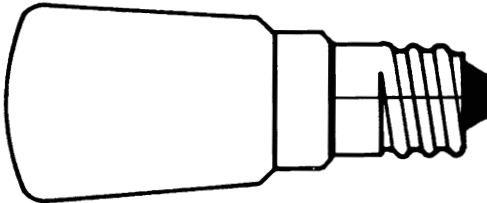

E14 BASE

Ø ST28 x 65mm

191

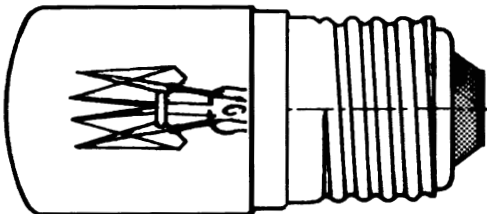

E27 BASE  
(ES)

Ø 28 x 65mm

For specifications, price and availability call...

Phone: (02) 4351 3377

*ASI Lamps*

Fax: (02) 4351 6627

# PILOT LAMPS - cont.

DEPICTED IN ACTUAL SIZE

192

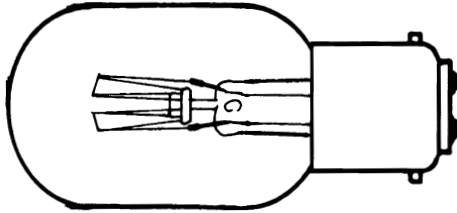

BA15D  
BASE

Ø 28 x 60mm

193

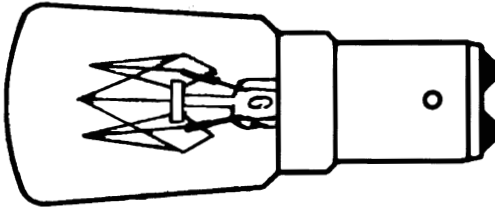

BA15D  
BASE

Ø ST28 x 65mm

194

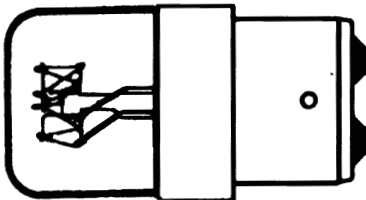

FLUSH PILOT  
B22 (BC) BASE

Ø 26 x 48mm

195

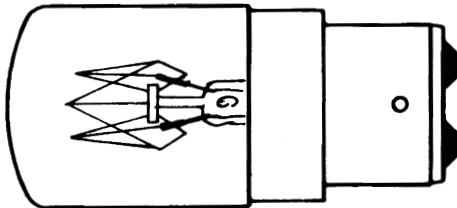

NORMAL  
PILOT  
B22 BASE

Ø 28 x 60mm

For specifications, price and availability call...

Phone: (02) 4351 3377

*ASI Lamps*

Fax: (02) 4351 6627



# MISCELLANEOUS & FLUORESCENT

DEPICTED IN ACTUAL SIZE

196

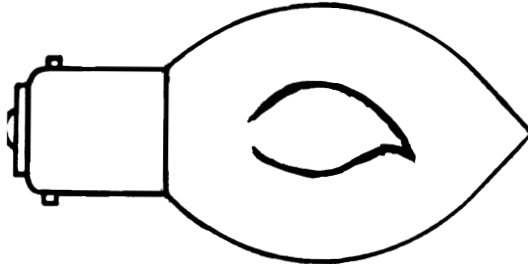

NEON  
FLICKER  
FLAME

NOT TO  
SCALE

Ø 35 x 75mm

197

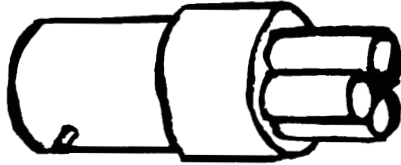

SIGNALITE  
3 LONG LIFE  
FILAMENTS

REFER TO ASSOCIATED SWITCHGEAR

For specifications, price and availability call...

Phone: (02) 4351 3377

*ASI Lamps*

Fax: (02) 4351 6627

# GLASS FUSES – Fast Blow

DEPICTED IN ACTUAL SIZE

**300**



2AG

Ø 5.0 x 20mm

**301**

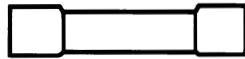

3AG

Ø 6.3 x 32mm

**302**

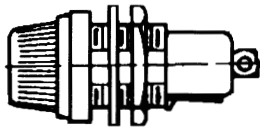

FUSE HOLDER  
2AG

Ø 16 x 35mm

**303**

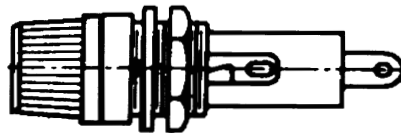

FUSE HOLDER  
3AG

Ø 18 x 52mm

For specifications, price and availability call...

Phone: (02) 4351 3377

*ASI Lamps*

Fax: (02) 4351 6627

# MULTI DIRECTIONAL LED

DEPICTED NOT TO SCALE

*Functional*

*Highly Decorative*

**305**

103 mm x 35 mm

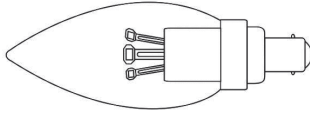

BA15 CANDLE

**310**

**306**

110 mm x 35 mm

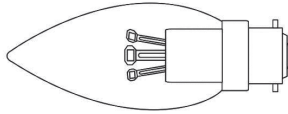

B22 CANDLE

**311**

**307**

105 mm x 35 mm

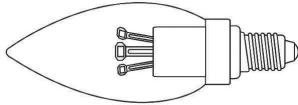

E12 CANDLE

**312**

**308**

110 mm x 35 mm

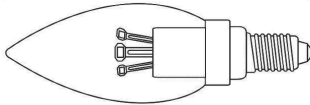

E14 CANDLE

**313**

**309**

110 mm x 35 mm

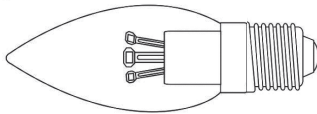

E27 CANDLE

**314**

For specifications, price and availability call...

Phone: (02) 4351 3377

*ASI Lamps*

Fax: (02) 4351 6627

# MULTI DIRECTIONAL LED

DEPICTED NOT TO SCALE

*Functional*

*Highly Decorative*

**315**

90 mm x 50 mm

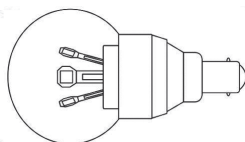

BA15 G50

**320**

**316**

95 mm x 50 mm

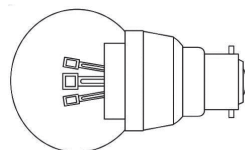

B22 G50

**321**

**317**

92 mm x 50 mm

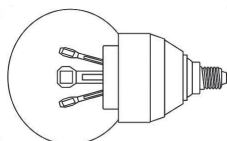

E12 G50

**322**

**318**

98 mm x 50 mm

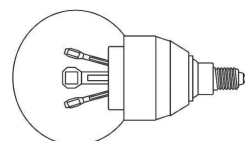

E14 G50

**323**

**319**

97 mm x 50 mm

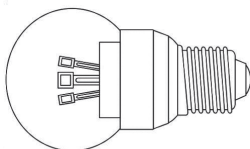

E27 G50

**324**

For specifications, price and availability call...

Phone: (02) 4351 3377

*ASI Lamps*

Fax: (02) 4351 6627

# MULTI DIRECTIONAL LED

DEPICTED NOT TO SCALE

*Functional*

*Highly Decorative*

**325**

103 x 60 mm

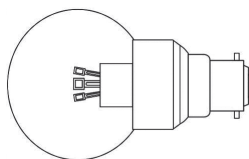

B22 PS60

**337**

**326**

97 x 50 mm

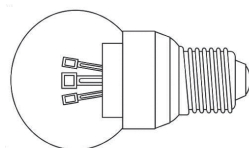

E27 PS60

**338**

**339**

35 x 35 mm

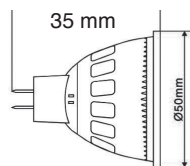

MR11

**340**

**341**

51 x 50 mm

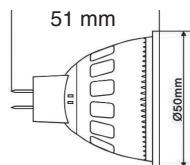

MR16

**342**

**343**

58 x 50 mm

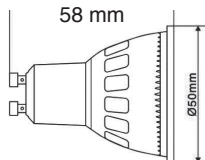

GU10

**344**

For specifications, price and availability call...

Phone: (02) 4351 3377

*ASI Lamps*

Fax: (02) 4351 6627

**45**

# MULTI DIRECTIONAL LED

DEPICTED NOT TO SCALE

*Functional*

*Highly Decorative*

**345**

83 mm x 50 mm

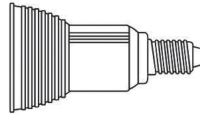

E14 JDR

**347**

**346**

79 mm x 50 mm

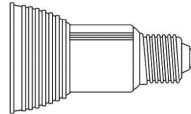

E27 JDR

**348**

For specifications, price and availability call...

Phone: (02) 4351 3377

*ASILamps*

Fax: (02) 4351 6627

# MULTI DIRECTIONAL LED

DEPICTED NOT TO SCALE

360

BA15S 13 CHIP

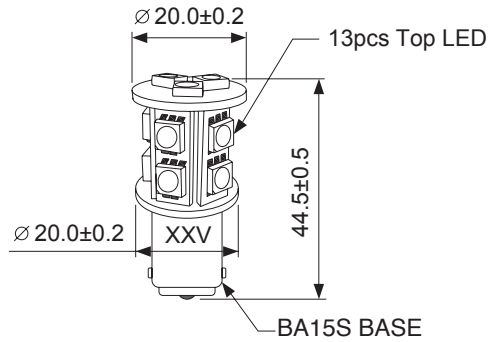

361

BA15S 18 CHIP

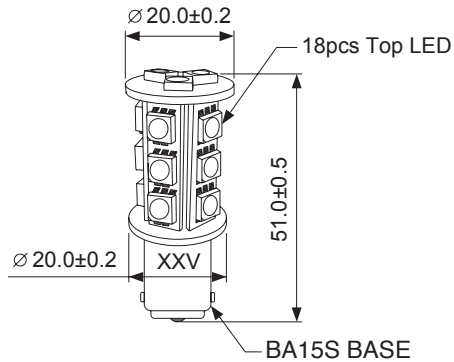

362

E14 13 CHIP

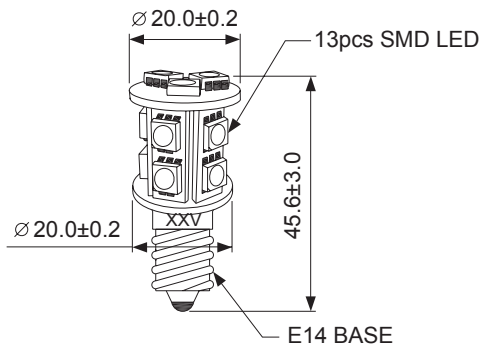

For specifications, price and availability call...

Phone: (02) 4351 3377

*ASI Lamps*

Fax: (02) 4351 6627

# MULTI DIRECTIONAL LED

DEPICTED NOT TO SCALE

**363**

E14 18 CHIP

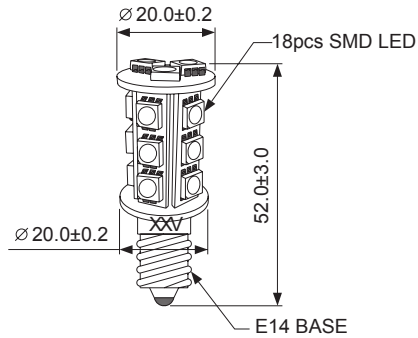

**364**

BA15D 13 CHIP

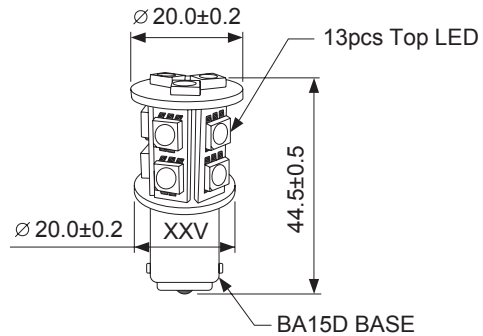

**365**

BA15D 18 CHIP

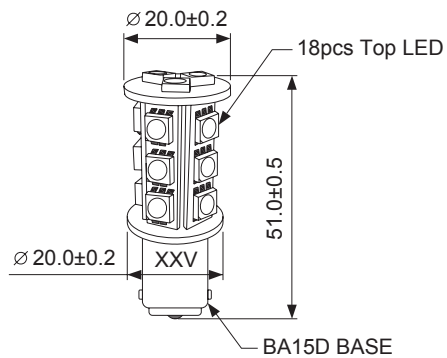

For specifications, price and availability call...

Phone: (02) 4351 3377

*ASi Lamps*

Fax: (02) 4351 6627



# MULTI DIRECTIONAL LED

DEPICTED NOT TO SCALE

**366**

**BAY 15D 13 CHIP**

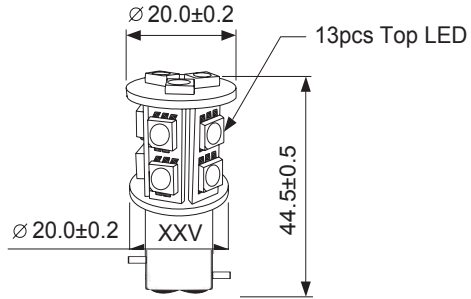

**367**

**BAY 15D 18 CHIP**

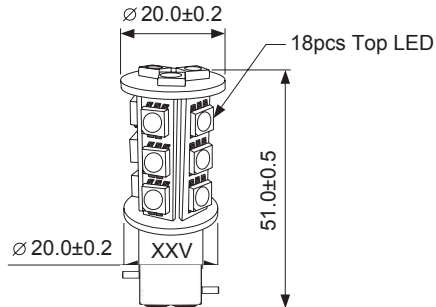

For specifications, price and availability call...

Phone: (02) 4351 3377

*ASILamps*

Fax: (02) 4351 6627

# MULTI DIRECTIONAL LED

DEPICTED NOT TO SCALE

370

G4 13 CHIP

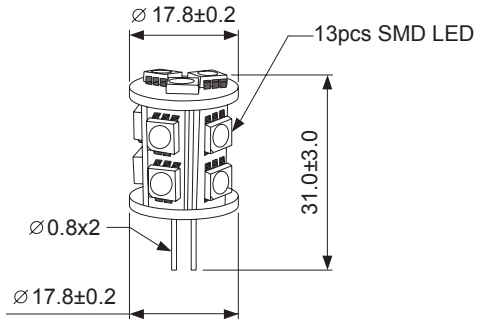

371

G4 18 CHIP

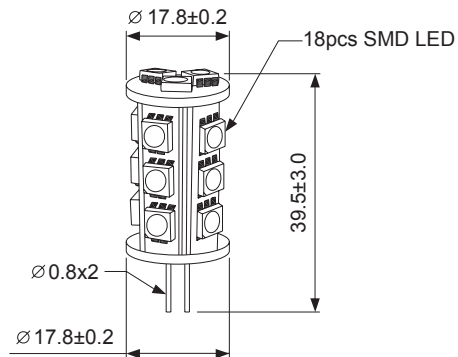

380

SILICON G4

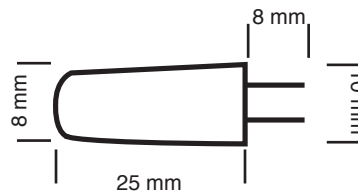

For specifications, price and availability call...

Phone: (02) 4351 3377

*ASI Lamps*

Fax: (02) 4351 6627

# LAMP SOCKETS & ACCESSORIES

DEPICTED IN ACTUAL SIZE

400

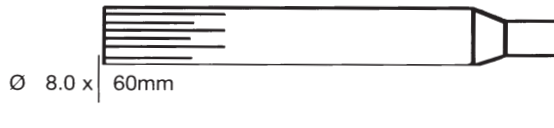

LAMP  
INSERTION  
TOOL

401

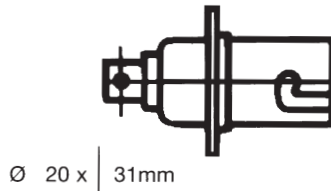

BA9S SOCKE

402

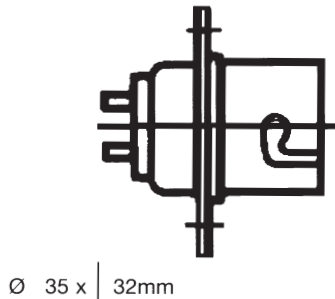

BA15D  
SOCKET

403

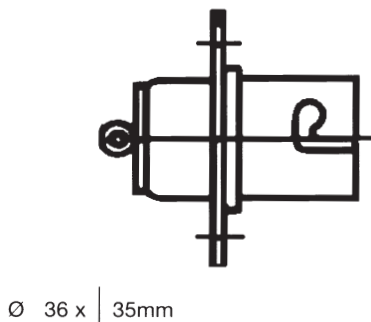

BA15S  
SOCKET

For specifications, price and availability call...

Phone: (02) 4351 3377

*ASI Lamps*

Fax: (02) 4351 6627

# LAMP SOCKETS & ACCESSORIES

DEPICTED IN ACTUAL SIZE

404



E10 SOCKET

405



E12 SOCKET

406

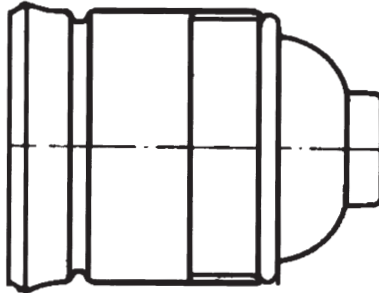

E14 SOCKET

407



T5  
WEDGE BASE

For specifications, price and availability call...

Phone: (02) 4351 3377

*ASI Lamps*

Fax: (02) 4351 6627

# LAMP SOCKETS & ACCESSORIES

DEPICTED IN ACTUAL SIZE

408

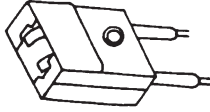

T10 WEDGE BASE

409

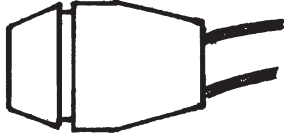

T10  
WEDGE BASE  
SILICON  
RUBBER

410

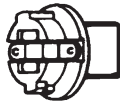

T5 WEDGE BASE  
SOCKET  
FOR PCB MOUNT

411

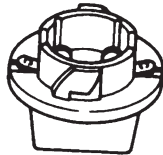

T10 WEDGE BASE  
SOCKET  
FOR PCB MOUNT

For specifications, price and availability call...

Phone: (02) 4351 3377

*ASI Lamps*

Fax: (02) 4351 6627

# LAMP SOCKETS & ACCESSORIES

DEPICTED IN ACTUAL SIZE

412

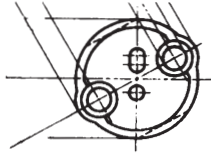

CERAMIC SOCKET  
G4 & G6.35

413

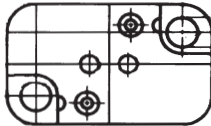

CERAMIC  
SOCKET

414



LAMP SOCKET  
ADAPTOR

*Various Types and Sizes*

For specifications, price and availability call...

Phone: (02) 4351 3377

*ASI Lamps*

Fax: (02) 4351 6627

# Electrical Characteristics

## LAMP RE-RATING

Since incandescent lamps may be re-rated to suit various design goals, existing standard lamps should be reviewed prior to initiation of a new lamp design. Three basic formulas apply when re-rating a lamp, assuming that  $V_A$  equals application voltage and  $V_D$  equals design voltage, the following may be applied:

**Re-rated MSCP**  $\left\{ \frac{V_A}{V_D} \right\}^{3.5}$  x MSCP. at  $V_D$

**Re-rated Life**  $\left\{ \frac{V_D}{V_A} \right\}^{12}$  x Life at  $V_D$

**Re-rated Current**  $\left\{ \frac{V_A}{V_D} \right\}^{.55}$  x Current at  $V_D$

## CHARACTERISTIC INTER-RELATIONSHIPS OF INCANDESCENT LAMPS

The chart illustrates the correlation between voltage, current, candlepower and may be used as a guide in the application of vacuum type lamps.

Following is an example of the charts use. A 5 volt lamp operated at 6v or 120% of design voltage yields the following characteristics:

- MSCP** = 1.893 x 5v MSCP rating
- Life** = .112 x 5v life rating
- Current** = 1.105 x 5v current rating

## DE-RATED

% Design Voltage	% Design Amps	% Design Watts	% Design MSCP	% Design Life
50	68	34	8	409600
55	72	39	12	130511
60	75	45	16	45939
65	78	51	22	17580
70	82	57	28	7224
75	85	64	36	3156
80	88	70	45	1455
81	89	72	47	1253
82	89	73	49	1082
83	90	74	52	935
84	90	76	54	810
85	91	77	56	703
86	92	79	59	611
87	92	80	61	531
88	93	82	63	463
89	93	83	66	404
90	94	85	69	354
91	94	86	71	310
92	95	87	74	272
93	96	89	77	238
94	96	91	80	210
95	97	92	83	185
96	97	93	86	163
97	98	95	89	144
98	98	96	93	127
99	99	98	96	112
100	100	100	100	100

# Electrical Characteristics — cont.

## OVER-RATED

% Design Voltage	% Design Amps	% Design Watts	% Design MSCP	% Design Life
101	100	101	103	88
102	101	103	107	78
103	101	104	110	70
104	102	106	114	62
105	102	107	118	55
106	103	109	122	49
107	103	111	126	44
108	104	112	130	39
109	104	114	135	35
110	105	115	139	31
111	105	117	144	28
112	106	119	148	25
113	107	120	153	23
114	107	122	158	20
115	108	124	163	18
116	108	125	168	16
117	109	127	173	15
118	109	129	178	13
119	110	130	183	12
120	110	132	189	11
125	113	141	218	6
130	115	150	250	4
135	117	159	285	2
140	120	168	324	1
145	122	177	367	1
150	125	187	413	0

Calculations of characteristics for lamps operated at more than  $\pm 10\%$  of rated volts will result in values which may vary widely from the actual results.

## COLOUR TEMPERATURE

The lamps illustrated are of the vacuum type with filament temperature changing from 1800 to 2200°K.

The visible efficiency of the filaments expressed in Mean Spherical Candle Power (MSCP) per watt versus filament temperature is show top right:

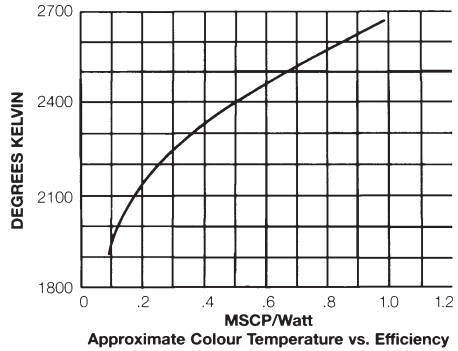

## INRUSH CURRENT

The initial current applied to a cold filament can be 10-12 times greater than the lamps rated current. As resistance causes filament temperature to rise, inrush current decreases. The steady state value of current is reached when the thermal energy output is equal to the electrical energy input. Inrush current can be reduced by using a low voltage to preheat the filament, and is an important consideration when lamps are used in a flashing or pulsating display.

## FLASHING/PULSING

Subminiature vacuum lamps can be used in flashing or pulsating applications without reduction in life so long as the pulsing or flashing mode does not exceed that of the steady state operating specification.

## RISE TIME

By varying filament wire diameter, coil size and spacing as well as voltage and current, the rise time of a miniature lamp may be varied from 20 to 200 milliseconds from cold to operating temperature.

The rise time of a given lamp may be accelerated by the use of a waveform with a high voltage front, phased in time to reduce it to design voltage level when the filament reaches design temperature.